

CATALOG 0

SINCE 1915  
MANUFACTURERS OF ELECTRONIC APPARATUS FOR SCIENCE AND INDUSTRY

GENERAL RADIO  
COMPANY



CAMBRIDGE 39, MASS.  
U. S. A.

# GENERAL RADIO COMPANY

## *Main Office and Factory*

275 MASSACHUSETTS AVENUE, CAMBRIDGE 39, MASSACHUSETTS

Telephone (Boston) TRowbridge 6-4400

## *Branch Factory*

(Production Only)

West Concord, Massachusetts

Telephone (Concord) EMerson 9-4400

## DISTRICT OFFICES

General Radio sales engineering offices are maintained in New York, Philadelphia, Washington, Chicago, and Los Angeles. These offices are staffed with competent factory-trained engineers. We invite your inquiries for technical, commercial, and service information.

Office	Telephone	Staff
New York City 90 West Street, New York 6, N. Y.	WOrth 4-2722	G. G. Ross, <i>Manager</i> C. W. Harrison
Philadelphia 1150 York Road, Abington, Pa.	HAncock 4-7419	K. Adams, <i>Manager</i>
Washington and Baltimore 8055 13th Street, Silver Spring, Md.	JUniper 5-1088	W. R. Saylor, <i>Manager</i>
Chicago 920 South Michigan Avenue, Chicago 5, Ill.	WAbash 2-3820	W. M. Ihde, <i>Manager</i> R. E. Bard
Los Angeles 1000 North Seward Street, Los Angeles 38, Calif.	HOLlywood 9-6201	F. Ireland, <i>Manager</i> J. G. Hussey

"Enterprise" telephone service is available in several other localities, including Arizona, Phoenix; California, Berkeley, Mountain View, Oakland, Palo Alto, San Diego, and San Francisco; New Jersey, Eatontown; New Mexico, Albuquerque; Ohio, Cleveland and Dayton; Washington, Seattle. Ask us for further information.

## REPAIR SERVICES

### *West Coast*

Western Instrument Co.  
826 North Victory Boulevard, Burbank, California  
Telephone: VICTORIA 9-3013

### *Canada*

Bayly Engineering, Ltd.  
First Street, Ajax, Ontario  
Telephone: EMpire 8-6866

## EXPORT DISTRIBUTORS

For a list of distributors in other countries see inside back cover

# QUICK INDEX

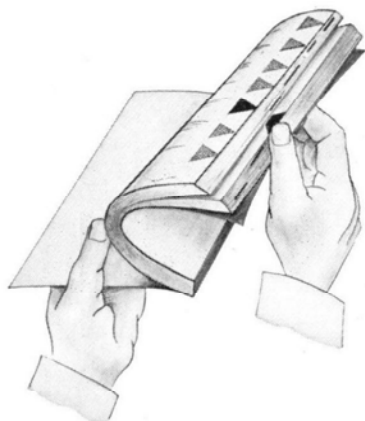

The QUICK INDEX listed here and on the back cover is for your convenience in finding sections of this catalog quickly.

Bend the catalog as shown in the sketch above. The arrows point to the black tabs on the first page of each section. Run your thumb across the edge of the pages to the tab for the section you want, and open the catalog to the general introduction which starts each section.

A complete INDEX BY TITLE and an INDEX BY TYPE NUMBER are given in the last pages of the catalog.

HOW TO ORDER . . . . .	vii	
AMPLIFIERS . . . . .	1	
BRIDGES . . . . .	7	
COAXIAL ELEMENTS . . . . .	45	
DETECTORS . . . . .	63	
FREQUENCY AND TIME . . . . .	71	
GENERATORS	STANDARD-SIGNAL . . . . .	91
	OSCILLATORS . . . . .	101
	PULSE AND RANDOM NOISE . . . . .	119
METERS . . . . .	127	
MONITORS FOR RADIO AND TV STATIONS . . . . .	137	
POWER SUPPLIES . . . . .	145	
REACTANCE . . . . .	CAPACITORS INDUCTORS	149
RESISTORS . . . . .	167	
SOUND AND VIBRATION . . . . .	177	
STROBOSCOPES . . . . .	191	
SWEEP DRIVES . . . . .	199	
UNIT INSTRUMENTS . . . . .	205	
VARIAC <sup>®</sup> AUTOTRANSFORMERS AUTOMATIC VOLTAGE REGULATOR MOTOR SPEED CONTROLS . . . . .	207	
WAVEFORM-MEASURING EQUIPMENT . . . . .	223	
PARTS AND ACCESSORIES . . . . .	229	
CHARTS, TABLES, AND INDEXES . . . . .	243	

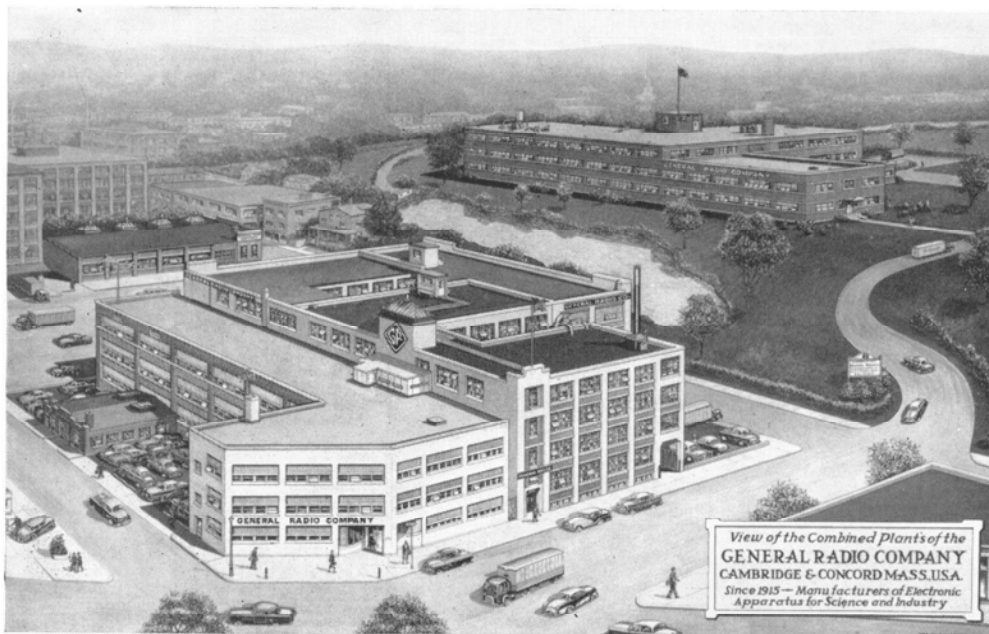

## We Sell Direct . . .

To develop the type of product manufactured by the General Radio Company requires a large staff of engineers, each a specialist in one or more branches of electronic engineering and science.

There has always been close contact between our Company and our customers, many of whom are themselves engineers and scientists. To maintain and to further this contact is the responsibility of our staff of field engineers. This group has the principal function of working directly with the customer for the best selection of instruments for the job with the minimum expenditure. The advice of our development engineering staff is available for expert consultation when the need arises.

Because of the technical nature and diverse uses of our equipment we feel that a direct method of distribution is the most efficient. Consequently, the General Radio Company sells its products directly to the user in the United States, with no intermediary distributing organization, on a net, no discount basis. The buyer is thus assured of receiving the lowest possible price and one that he can immediately find by consulting a current price list. We have always felt that price is as much a part of specifications as is a technical description.

In several major cities of the United States the Company maintains factory branch offices, which are staffed by skilled factory-trained engineers who are in a position to speak directly for the factory, and who are conveniently available for consultation on all technical and commercial questions. The locations of these offices are given in the inside front cover.

In order that customers outside the United States may receive equivalent technical service, exclusive distributors have been appointed in many foreign countries, each capable of giving technical and commercial information regarding General Radio products. For a list of export distributors, see the inside back cover of this catalog. In all matters regarding General Radio apparatus, the customer should communicate with the appropriate distributor. Prices listed in the catalog are for domestic use only. Costs in countries abroad, where import duty, freight, and taxes must be added, may be obtained from the distributors in those countries.

**GENERAL RADIO COMPANY**

# CATALOG



JUNE, 1956

## GENERAL RADIO COMPANY

CAMBRIDGE 39, MASSACHUSETTS

NEW YORK

CHICAGO

LOS ANGELES

PHILADELPHIA

WASHINGTON

U. S. A.

Copyright, 1956, by General Radio Company, Cambridge, Mass., U.S.A.

## THE HALLMARK OF QUALITY

Quality is traditional in products that bear the  label. General Radio instruments are quality instruments, built from quality components for reliable service and long life.

Performance specifications are one yardstick for quality. General Radio specifications are conservative and honest. Each instrument is calibrated to tolerances at least 25% tighter than published. Temperature rises during

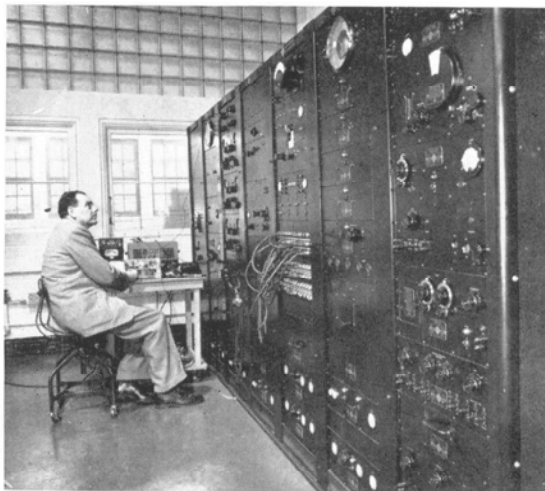

For more than 40 years, General Radio has been manufacturing standards for the electronics industry — resistance, capacitance, inductance, and frequency. Above is shown the primary frequency standard in the General Radio development laboratories. The frequency of this standard is known at all times to two parts in one hundred million.

The accuracy of a precision air capacitor depends upon the maintenance of close mechanical tolerances — from the fabrication of each part to the final assembly. Here, the capacitors undergo adjustment and alignment in a jig to assure linearity of the capacitance characteristic.



operation are generally kept below 40° so as to eliminate heat deterioration as a factor in instrument life.

Although published specifications attest the accuracy, range, and versatility of GR products and indicate the ingenuity and care which go into their design and development, they cannot disclose all the attention to detail which makes for customer satisfaction and long and useful service.

Tangible evidence of these quality details is readily seen in a typical instrument. The panel and cabinet are of exceptionally heavy gauge aluminum alloy (usually  $\frac{1}{8}$  to  $\frac{1}{4}$  in.) so that they will not hum, dent, buckle, rattle or rust. Relay-rack cabinets readily adapt from drawer-slide rack mounting to neat looking bench units by the addition of end frames which provide feet and handles. Dials are a sturdy .050" thick, have low-reflective backgrounds with markings carefully proportioned for easy reading and have concentric lathe-turned edges. The rugged phenolic knobs with reamed brass inserts are a widely copied design of General Radio origin. Binding posts, coaxial connectors, handles, panel screws and other items are of proprietary GR design and were created to provide instrument components of instrument grade rather than ordinary commercial grade.

Inside the instrument are precision components, air capacitors, potentiometers, and transformers, developed and manufactured at General Radio specifically for instrument use. The special qualities of all these parts are proved by the fact that they are widely pur-

To speed production on the thousands of control knobs that go into GR instruments, the semi-automatic machine shown at left bores, drills, counterbores, taps, and inserts setscrews into each knob.

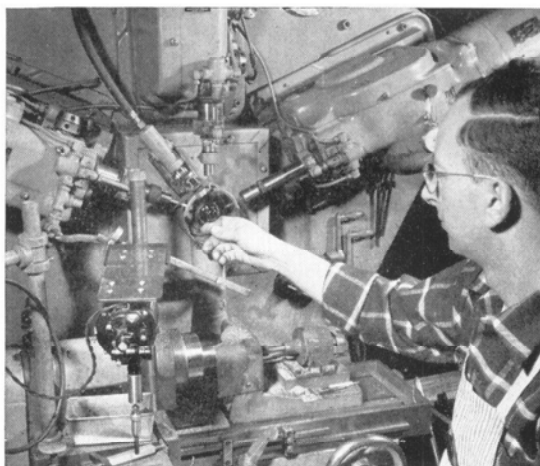

chased as individual components by other manufacturers. The etched circuits found in more recent instruments have 0.003 in. copper on  $\frac{3}{32}$  in. minimum phenolic and carry miniature sockets, made exclusively to General Radio specifications, which provide tube shields and satisfactorily resilient terminals. Rugged chasses and brackets are built to withstand military vibration tests as insurance against shipping and handling damage. Shielded leads are permanently terminated with a novel crimped-ferrule construction.

Cables, which add so much to the appearance of an instrument, are nylon-braided by a machine especially designed at GR for the purpose. From the many materials tested, nylon has proved to be the best material, not only for its ability to wrap tightly and uniformly around any diameter, but also for its non-hygroscopic property, which insures against trapping moisture within the cable.

All these parts and components and all the design practices characteristic of General Radio instruments are controlled by a comprehensive standards program, which keeps the number of different pieces, tools and procedures to an economic minimum, thereby making possible high quality at moderate prices. The standards program also includes constant study and testing to evaluate and to maintain quality. The manufacture of the products is carried out by skilled workmen, and quality is further assured by frequent stages of inspection.

Additional evidence of General Radio thoroughness and attention to detail is obtained by actually doing business with the Company.

This machine, designed and built at General Radio, automatically mills from blocks of aluminum complete rotors and stators for variable capacitors.

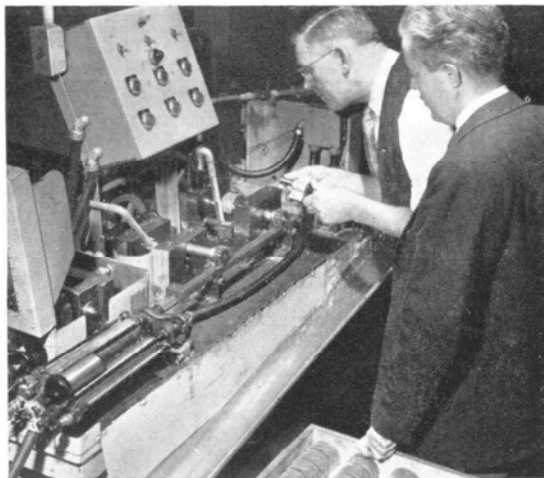

GR offers expert technical sales-engineering consultants, all graduate engineers and factory trained; convenient district offices; efficient handling of commercial paper-work; special handling for non-catalog items; useful technical publications, including the monthly *Experimenter*, reprints of technical papers, catalogs, bulletins, and the instruction manuals which accompany each instrument; and a competent service organization for repairs and replacement parts.

The General Radio Company zealously guards its reputation for integrity, ability, and quality.



The coils for Variac® autotransformers are wound on the GR-designed machine, shown above, which applies an evenly spaced winding, accurately banked.

In the assembly department, each man assembles a group of instruments, performing operations on each successively. Versatility is a prime requirement, because in the course of a year a man will assemble dozens of different products.



GENERAL RADIO COMPANY

V

## THE HALLMARK OF QUALITY

Quality is traditional in products that bear the  label. General Radio instruments are quality instruments, built from quality components for reliable service and long life.

Performance specifications are one yardstick for quality. General Radio specifications are conservative and honest. Each instrument is calibrated to tolerances at least 25% tighter than published. Temperature rises during

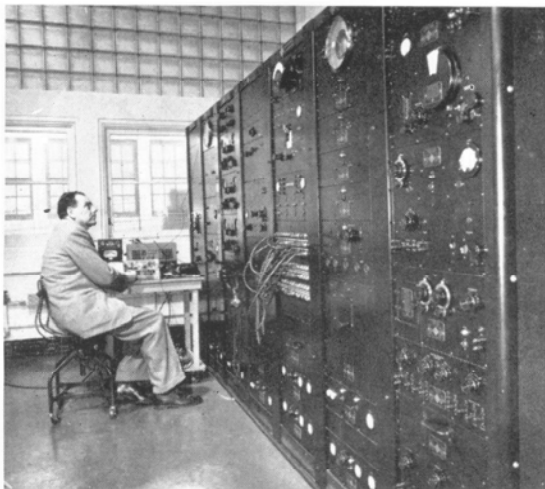

For more than 40 years, General Radio has been manufacturing standards for the electronics industry — resistance, capacitance, inductance, and frequency. Above is shown the primary frequency standard in the General Radio development laboratories. The frequency of this standard is known at all times to two parts in one hundred million.

The accuracy of a precision air capacitor depends upon the maintenance of close mechanical tolerances — from the fabrication of each part to the final assembly. Here, the capacitors undergo adjustment and alignment in a jig to assure linearity of the capacitance characteristic.



operation are generally kept below 40° so as to eliminate heat deterioration as a factor in instrument life.

Although published specifications attest the accuracy, range, and versatility of GR products and indicate the ingenuity and care which go into their design and development, they cannot disclose all the attention to detail which makes for customer satisfaction and long and useful service.

Tangible evidence of these quality details is readily seen in a typical instrument. The panel and cabinet are of exceptionally heavy gauge aluminum alloy (usually  $\frac{1}{8}$  to  $\frac{1}{4}$  in.) so that they will not hum, dent, buckle, rattle or rust. Relay-rack cabinets readily adapt from drawer-slide rack mounting to neat looking bench units by the addition of end frames which provide feet and handles. Dials are a sturdy .050" thick, have low-reflective backgrounds with markings carefully proportioned for easy reading and have concentric lathe-turned edges. The rugged phenolic knobs with reamed brass inserts are a widely copied design of General Radio origin. Binding posts, coaxial connectors, handles, panel screws and other items are of proprietary GR design and were created to provide instrument components of instrument grade rather than ordinary commercial grade.

Inside the instrument are precision components, air capacitors, potentiometers, and transformers, developed and manufactured at General Radio specifically for instrument use. The special qualities of all these parts are proved by the fact that they are widely pur-

To speed production on the thousands of control knobs that go into GR instruments, the semi-automatic machine shown at left bores, drills, counterbores, taps, and inserts setscrews into each knob.

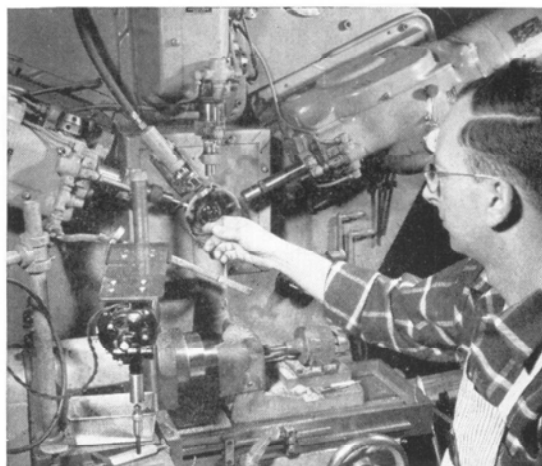



chased as individual components by other manufacturers. The etched circuits found in more recent instruments have 0.003 in. copper on  $\frac{3}{32}$  in. minimum phenolic and carry miniature sockets, made exclusively to General Radio specifications, which provide tube shields and satisfactorily resilient terminals. Rugged chasses and brackets are built to withstand military vibration tests as insurance against shipping and handling damage. Shielded leads are permanently terminated with a novel crimped-ferrule construction.

Cables, which add so much to the appearance of an instrument, are nylon-braided by a machine especially designed at GR for the purpose. From the many materials tested, nylon has proved to be the best material, not only for its ability to wrap tightly and uniformly around any diameter, but also for its non-hygroscopic property, which insures against trapping moisture within the cable.

All these parts and components and all the design practices characteristic of General Radio instruments are controlled by a comprehensive standards program, which keeps the number of different pieces, tools and procedures to an economic minimum, thereby making possible high quality at moderate prices. The standards program also includes constant study and testing to evaluate and to maintain quality. The manufacture of the products is carried out by skilled workmen, and quality is further assured by frequent stages of inspection.

Additional evidence of General Radio thoroughness and attention to detail is obtained by actually doing business with the Company.

This machine, designed and built at General Radio, automatically mills from blocks of aluminum complete rotors and stators for variable capacitors.

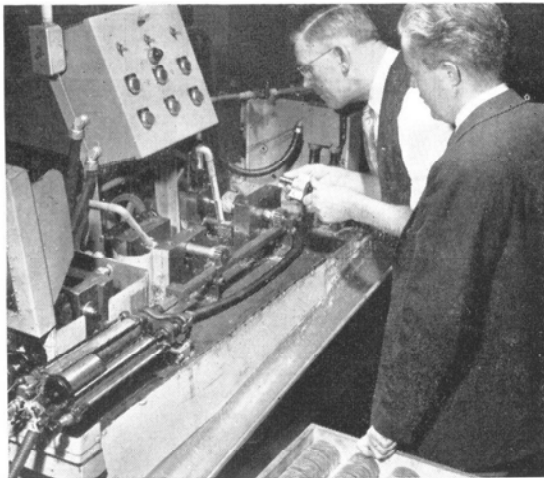

GR offers expert technical sales-engineering consultants, all graduate engineers and factory trained; convenient district offices; efficient handling of commercial paper-work; special handling for non-catalog items; useful technical publications, including the monthly *Experimenter*, reprints of technical papers, catalogs, bulletins, and the instruction manuals which accompany each instrument; and a competent service organization for repairs and replacement parts.

The General Radio Company zealously guards its reputation for integrity, ability, and quality.



The coils for Variac<sup>®</sup> autotransformers are wound on the GR-designed machine, shown above, which applies an evenly spaced winding, accurately banked.

In the assembly department, each man assembles a group of instruments, performing operations on each successively. Versatility is a prime requirement, because in the course of a year a man will assemble dozens of different products.



GENERAL RADIO COMPANY

V

## SUGGESTIONS FOR ORDERING

### ORDER BY TYPE NUMBER

Always order by catalog type number, and, whenever possible, mention name of item, ranges, or other significant specifications as protection against misunderstanding.

Be sure to include orders for any accessories desired or for calibrations which must be made before shipment. When minor modifications are desired to adapt the equipment to the customer's purposes, our Sales Engineering Department will be glad to discuss the details.

For EXPORT ORDERS please state the desired line-voltage and frequency. For example: 230 volts/50 c; 115 volts/50 c.

### TELEGRAPH AND CABLE ORDERS

We have direct telegraph printer connections with Western Union for the prompt handling of messages.

Use the code words accompanying each catalog description. Our cable address is GENRADCO BOSTON.

### PACKING

There is no charge for our regular or domestic or export packing and no charge for shipping containers or cases. Cases are not returnable.

### SHIPPING INSTRUCTIONS

Unless specific instructions accompany the order, we shall use our judgment as to the best method of shipment. Repair parts or other items needed quickly can be shipped by air if requested. The following table shows approximate cost of four different methods of shipment to major cities in the United States, door-to-door.

**Export Shipments** via air-freight under 35 pounds are advantageous in many cases. They save transport costs and time. For example: the estimated charges, factory to Milan, Italy for the Type 1551-A Sound-Level Meter (Shipping weight, 16 pounds by air, 24 pounds by ocean freight) are \$24.25 for air-freight and \$46.96 for ocean carrier via New York. Air shipping weight is approximately 50 percent more than the net weight.

CITY	2 POUNDS				5 POUNDS				25 POUNDS				40 POUNDS			
	Air Freight	Air Ex-press	Air Parcel Post	Rail Ex-press	Air Freight	Air Ex-press	Air Parcel Post	Rail Ex-press	Air Freight	Air Ex-press	Air Parcel Post	Rail Ex-press	Air Freight	Air Ex-press	Air Parcel Post	Rail Ex-press
BUFFALO.....	\$6.60	\$2.50	\$1.15	\$1.93	\$6.60	\$2.57	\$2.65	\$1.93	\$6.60	\$4.85	\$12.65	\$2.92	\$6.60	\$6.56	\$20.15	\$3.72
DETROIT.....	7.70	2.50	1.26	1.93	7.70	2.89	2.94	1.95	7.70	6.45	14.14	3.38	7.70	9.12	22.54	4.45
CHICAGO.....	8.65	2.55	1.26	1.93	8.65	3.37	2.94	2.00	8.65	8.85	14.14	3.64	8.65	12.96	22.54	4.87
ST. LOUIS.....	9.25	2.61	1.39	1.93	9.25	3.53	3.31	2.04	9.25	9.65	16.11	3.89	9.25	14.24	25.71	5.28
ATLANTA.....	11.35	2.55	1.26	1.93	11.35	3.37	2.94	2.02	11.35	8.85	14.14	3.77	11.35	12.96	22.54	5.07
HOUSTON.....	15.35	3.00	1.47	1.93	15.35	4.49	3.63	2.23	15.35	14.45	18.03	4.80	15.35	21.92	28.83	6.73
DALLAS.....	12.25	3.00	1.47	1.93	12.25	4.49	3.63	2.21	12.25	14.45	18.03	4.74	12.25	21.92	28.83	6.62
LOS ANGELES.....	18.65	3.51	1.60	1.96	18.65	5.77	4.00	2.51	18.65	20.85	20.00	6.21	18.65	32.16	32.00	8.98
SEATTLE.....	21.35	3.51	1.60	1.95	21.35	5.77	4.00	2.50	21.35	20.85	20.00	6.16	21.35	32.16	32.00	8.90
CLEVELAND.....	7.10	2.50	1.15	1.93	7.10	2.89	2.65	1.93	7.10	6.45	12.65	3.18	7.10	9.12	20.15	4.14

CITY	75 POUNDS				100 POUNDS				200 POUNDS				400 POUNDS			
	Air Freight	Air Ex-press	Air Parcel Post	Rail Ex-press	Air Freight	Air Ex-press	Air Parcel Post	Rail Ex-press	Air Freight	Air Ex-press	Air Parcel Post	Rail Ex-press	Air Freight	Air Ex-press	Air Parcel Post	Rail Ex-press
BUFFALO.....	\$7.87	\$10.55	—	\$5.60	\$7.87	\$13.40	—	\$6.93	\$13.14	\$26.80	—	\$13.86	\$6.07#	\$13.40#	—	\$6.93#
DETROIT.....	9.15	15.35	—	6.96	9.15	19.80	—	8.75	15.60	39.60	—	17.50	7.45#	19.80#	—	8.75#
CHICAGO.....	10.35	22.55	—	7.74	10.35	29.40	—	9.78	18.05	58.80	—	19.56	8.70#	29.40#	—	9.78#
ST. LOUIS.....	12.75	24.95	—	8.51	13.45	32.60	—	10.82	24.65	65.20	—	21.64	12.00#	32.60#	—	10.82#
ATLANTA.....	13.50	22.55	—	6.76	14.18	29.40	—	8.49	26.11	58.80	—	16.98	22.83#	29.40#	—	8.49#
HOUSTON.....	22.77	39.35	—	11.24	22.77	51.80	—	14.45	43.19	103.60	—	28.90	21.22#	51.80#	—	14.45#
DALLAS.....	17.25	39.35	—	11.03	19.29	51.80	—	14.19	36.33	103.60	—	28.38	17.84#	51.80#	—	14.19#
LOS ANGELES.....	25.50	58.55	—	15.45	25.50	77.40	—	20.07	48.35	154.80	—	40.14	23.85#	77.40#	—	20.07#
SEATTLE.....	25.90	58.55	—	15.31	25.90	77.40	—	19.88	49.95	154.80	—	39.76	24.50#	77.40#	—	19.88#
CLEVELAND.....	9.35	15.35	—	6.38	9.60	19.80	—	7.97	16.60	39.60	—	15.94	7.95#	19.80#	—	7.97#

# Rate per CWT. All rates subject to 3% Government tax.

### ADDRESS

All communications, except when otherwise advised, should be sent to 275 Massachusetts Avenue, Cambridge 39, Massachusetts, to one of our district offices (see inside front cover), or to the appropriate export representative.

### TERMS

All prices are F.O.B. Cambridge or West Concord, Massachusetts.

**Domestic Terms:** Net 30 days if credit has been arranged; otherwise payment is received

before shipment, shipment will be made C.O.D.

When full payment accompanies an order for equipment, except for repairs, we pay transportation charges to any point in the continental United States (not including Alaska and the Canal Zone) on carrier of our choice.

**Export Terms:** Full payment in advance of shipment or by sight-draft against irrevocable letter of credit at New York or Boston bank.

#### **REMITTANCES**

Should be made payable at par in Boston or New York funds.

#### **PRICE CHANGES**

All prices are subject to change without notice. Formal price quotations remain open for 30 days.

Prices shown will be increased by the amount of any applicable sales, use, excise, or similar taxes that are now in effect or that may hereafter be imposed by Federal, State, or local governments.

#### **NO TRADE OR EDUCATIONAL DISCOUNTS**

Our prices are established on a direct-to-customer basis, which permits no special discounts. By the elimination of distribution or special discounts, all users pay the lowest possible prices.

#### **QUANTITY DISCOUNTS**

When 10 or more identical parts (not instruments) are ordered at the same time for single shipment to a single destination in the continental United States (not including Alaska and the Canal Zone) and Canada, the following quantity discounts are allowed except as noted otherwise:

10-19.....	5 percent
20-99.....	10 percent
100 or more.....	15 percent

Questions regarding the applicability of quantity discounts to any item in this catalog will be answered promptly by our Sales Engineering or Commercial Departments.

#### **SPECIFICATION CHANGES**

We reserve the right to discontinue any item without notice and to change specifica-

tions at any time without incurring any obligation to incorporate new features in instruments or parts previously sold.

#### **WARRANTY**

We warrant each new instrument manufactured and/or sold by us to be free from defects in material and workmanship, our obligation under this warranty being limited to repairing or replacing any instrument or part thereof, except tubes and batteries, which shall, within one year after shipment to the original purchaser, prove after our examination to be defective.

#### **REPAIR PARTS**

When ordering repair parts, be sure to describe completely the parts required, also refer to the symbol numbers and description from the parts list, and give the type number and serial number from the panel of the instrument.

#### **RETURNED MATERIAL**

Repair service is available from the factory, Cambridge, Mass., or from the Repair Services listed on the inside front cover of this catalog.

When returning instruments for repair, recalibration, or for any other reason, please ask for Return Material Tag and shipping instructions. Please state type number and serial number of the instrument and date of purchase.

#### **DOMESTIC SALES AGENCIES**

Because of our direct-sales policy no general sales agencies are appointed. Complete stocks are carried only at the factory warehouse. Partial stocks are maintained at Los Angeles, New York, Philadelphia, and Washington branch offices.

#### **EXPORT DISTRIBUTORS**

Export sales are handled by resident representatives in most foreign countries. Complete technical and commercial information is available from these representatives, at the addresses listed on the inside back cover of the catalog.

## VISIT OUR LABORATORIES AND FACTORY

We cordially invite you to visit our engineering laboratories and main factory the next time that you are in the vicinity of Cambridge.

Our main plant is located in Cambridge (across the Charles River from Boston) at 275 Massachusetts Avenue. This is half way between the Massachusetts Institute of Technology and Central Square, Cambridge.

The accompanying map gives details for reaching the plant by public transportation or automobile.

HOURS FOR VISITORS: 10:00 A.M. to 4:00 P.M. every day except Saturdays, Sundays, and legal holidays in Massachusetts.

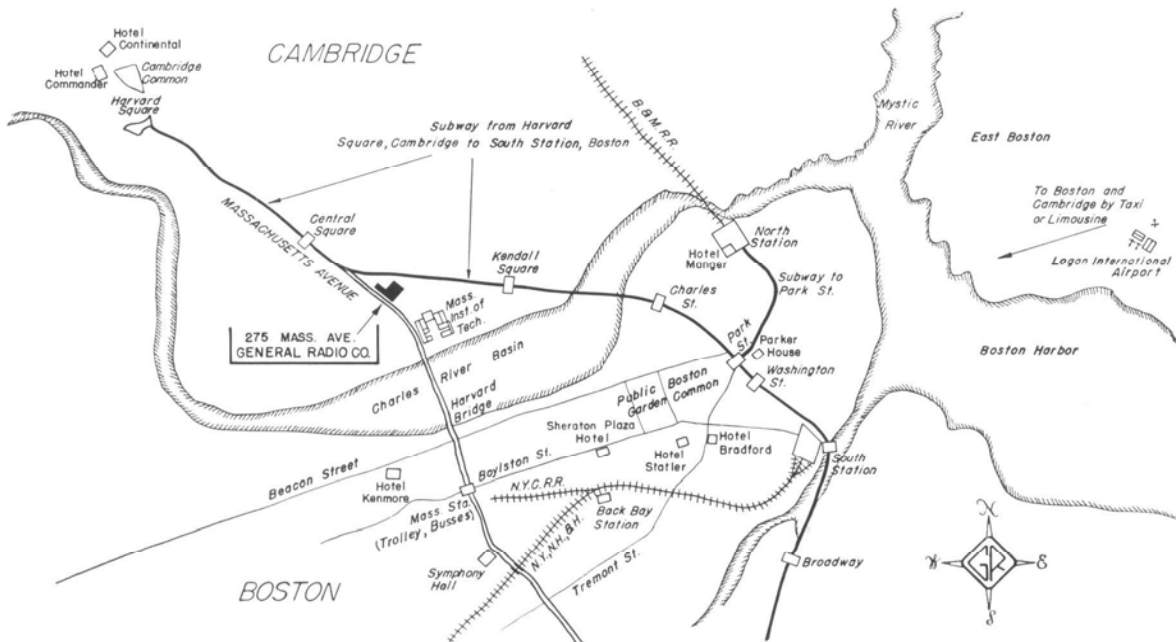

## PATENTS

Many of our products are manufactured and sold under United States Letters Patent owned by the General Radio Company or under license grants from other companies. To simplify the listing of these patents they are given here in a single list and referred to at each instrument only by appropriate reference number.

1. "Certain vacuum-tube amplifier devices, electric wave filters, vacuum-tube oscillators, and sound-level meters are licensed by Western Electric Company, Inc., under all United States Letters Patent owned or controlled by American Telephone and Telegraph Company, or Western Electric Company, Inc., and any or all other United States patents with respect to which Western Electric Company, Inc., has the right to grant a license, solely for utilization in research, investigation, measurement, testing, instruction, and development work in pure and applied science, including engineering and industrial fields."

2. "This apparatus uses inventions of United States Patents licensed by Radio Corporation of America.

Patent numbers supplied upon request. Licensed only for use in measuring or testing electronic devices, electron tube circuits, parts of such devices and circuits, and elements for use in such devices and circuits."

3. Patent D 161,030.
4. Patent 2,548,457.
5. Licensed under all patents and patent applications of Dr. G. W. Pierce pertaining to piezo-electric crystals and their associated circuits.
6. Licensed under designs, patents and patent applications of Edgerton, Germeshausen and Grier.
7. Patent 2,294,941.
8. Patent Applied For.
9. Patent 2,173,427.
10. Patent 2,367,681.
11. Patent 2,374,248.
12. Patent 2,376,394.
13. Patents D 142,777 and D 143,807.
14. Patent 2,173,426.
15. Patent 2,298,177.
16. Patent 2,362,503.
17. Patent 2,354,718.

# AMPLIFIERS

The General Radio Company manufactures a variety of laboratory amplifiers, which range from general-purpose, wide-range instruments to units specialized to perform a particular group of functions. Many of the needs for amplification which arise in measurements in research, engineering, and industry can be met with one of these instruments. The following amplifiers are described in this section:

The TYPE 1230-A D-C Amplifier and Electrometer is a new instrument replacing the well-known TYPE 715-A Direct-Current Amplifier. It is basically a millivoltmeter with an extremely high input resistance. It is also arranged to be used very conveniently as a micro-microammeter and mega-megohmmeter. Because of these features, together with its high sensitivity and excellent stability, this new instrument has a wide range of applications in d-c measurements.

The TYPE 1233-A Power Amplifier provides several watts of power over a wide frequency range. In addition to its uses at audio and ultrasonic frequencies, it can be used as a wide-band voltage amplifier at frequencies up to 3 Mc, and, with external tuning, as a tuned amplifier up to 5 Mc.

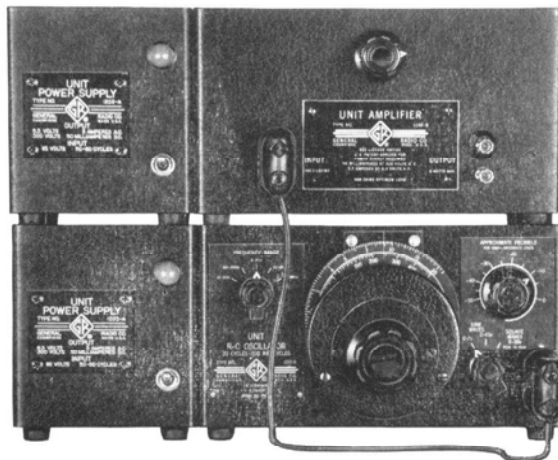

View of the TYPE 1206-A Unit Amplifier with the TYPE 1210-B Unit Oscillator. This combination delivers 3 watts over a range of 20 cycles to 50 kilocycles and 0.1 watt at 500 kilocycles.

The TYPE 1206-B Unit Amplifier is a general-purpose, 3-watt amplifier, which is useful over the audio and low-ultrasonic frequency ranges, and which has excellent transient response. It is housed in the compact Unit Instrument cabinet.

Type	Name	Page
1230-A	D-C Amplifier and Electrometer.....	2
1233-A	Power Amplifier.....	4
1206-B	Unit Amplifier.....	5

## OTHER GR AMPLIFIERS

Those amplifiers which, because of their specialized function, belong more properly in another section of this catalog, are listed in the table below.

**PULSE AMPLIFIER:** The TYPE 1219-A Unit Pulse Amplifier, designed to work with the TYPE 1217-A Unit Pulser, the TYPE 1391-A Pulse, Sweep, and Time-Delay Generator, and other pulse sources, is listed on page 123.

**I-F AMPLIFIER:** The TYPE 1216-A Unit I-F Amplifier, listed on page 68, is the basic unit in a heterodyne detector operating from 50 to 5000 Mc. Use it to measure gain, attenuation,

crossstalk, and signal level; also as a null detector. Has built-in, calibrated attenuator and meter.

**NULL DETECTOR:** TYPE 1231-B Amplifier and Null Detector, a high-gain audio amplifier for use as a null detector and standing-wave indicator is described on page 64.

The TYPE 1212-A Unit Null Detector (page 66) has an approximately logarithmic response over an input-signal range of 120 db and a frequency range extending to 5 Mc. While designed primarily for use as a null detector, it can also be used for the approximate measurement of relative signal levels.

Type	Name	Page
1212-A	Unit Null Detector.....	66
1216-A	Unit I-F Amplifier.....	68
1219-A	Unit Pulse Amplifier.....	123
1231-B	Amplifier and Null Detector.....	64



## TYPE 1230-A D-C AMPLIFIER AND ELECTROMETER

**USES:** The D-C Amplifier and Electrometer is basically a millivoltmeter with extremely high input resistance. It measures:

- Voltage — as low as 0.5 millivolt.
- Current — as low as  $5 \times 10^{-15}$  amperes.
- Resistance — up to  $5 \times 10^{14}$  ohms.

These quantities are indicated on a panel meter, and output is available to operate recorders and other equipment.

Because of its high sensitivity and excellent stability, this instrument has a wide range of applications in science, engineering, and industry. Typical examples include the measurement of:

Ionization currents, photo currents, grid currents in electron tubes, and time-current curves of capacitors during charge and discharge.

Piezo-electric potentials, bioelectric potentials, contact potentials, electrostatic field potentials, and pH indications.

Back resistance of silicon-junction diodes, interconductor resistance of cables, insulation resistance of electrical equipment, and voltage coefficient of resistance.

**DESCRIPTION:** The circuit is a three-stage direct-coupled amplifier that acts as a highly degenerated cathode follower and has high overall transconductance. Excellent linearity is obtained even on the lowest scales.

Voltage is measured directly; current is measured in terms of the voltage drop across a standard resistor, through which the current flows; and resistance in terms of a standard voltage source connected in series with the standard and unknown resistors.

To achieve maximum stability, power-supply voltages are stabilized; components are carefully chosen and well aged; chassis and sub-assemblies are shock mounted.

High input resistance, even under conditions of high humidity is achieved by use of an electrometer tube and by enclosure of the input grid lead in silicone-treated glass. Input resistance selector has switch contacts that are mounted on individual teflon bushings set in a metal base that connects to a guard point.

Input stage is completely shielded, and the coaxial input terminal permits this shielding to be extended to the unit under test. A fully shielded chamber, the TYPE 1230-P1 Component Shield, is available as an accessory, within which components to be measured can be quickly and easily connected.

Guard terminals are provided. The low input terminal can be grounded or not, as desired.

The output meter has two voltage scales and two resistance scales, which provide two ranges per decade. Terminals are provided for connecting an external meter or recorder. The Esterline-Angus (or equivalent) 5-ma and 1-ma Graphic Recorders are recommended, and the TYPE 1230-AE D-C Amplifier and Electrometer is installed in an Esterline-Angus case to match the recorder.



### SPECIFICATIONS

**Voltage Ranges:**  $\pm 30$ , 100 and 300 millivolts;  $\pm 1$ , 3 and 10 volts; dc, full-scale. Accuracy is  $\pm 2\%$  of full scale on the five highest ranges;  $\pm 4\%$  of full scale on the 30-mv range.

**Current Ranges:**  $\pm 1$  milliamperes d-c ( $10^{-3}$  amp.) full scale to  $\pm 300$  milli-microamperes ( $3 \times 10^{-13}$  amp.) full scale, in twenty ranges (two per decade). Accuracy is  $\pm 3\%$  of full scale from  $10^{-3}$  amp to  $3 \times 10^{-9}$  amp;  $\pm 10\%$  of full scale from  $10^{-10}$  amp to  $3 \times 10^{-13}$  amp.

**Frequency Characteristic:** With a 1500-ohm load at the OUTPUT terminals, the frequency characteristic is flat within 5% from zero to 10, 30, 100, 300, 1000 and 3000 cycles at the 30-, 100-, 300-millivolt, 1-, 3-, and 10-volt ranges, respectively.

**Resistance Ranges:** Direct reading in resistance from 300 kilohms to 10 mega-megohms ( $10^{13}$  ohms) at full scale ( $5 \times 10^{14}$  ohms at smallest meter division). There are sixteen ranges (two per decade). At full scale (low-

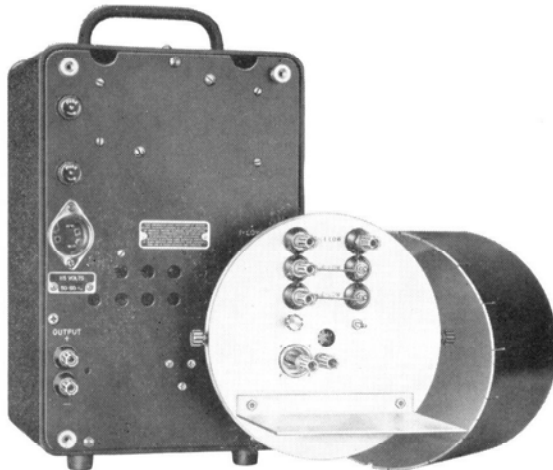

TYPE 1230-P1 Component Shield (with shield cover removed) plugged into the input terminal at the rear of the electrometer.



TYPE 1230-AE D-C Amplifier and Electrometer with a recorder.

resistance end) accuracy is  $\pm 3\%$  from  $3 \times 10^5$  ohms to  $10^{10}$  ohms;  $\pm 8\%$  from  $3 \times 10^{10}$  ohms to  $10^{12}$  ohms. The voltage across the unknown resistance is 9.1 volts.

The resistance range may be extended considerably, and voltage coefficients of resistors determined, by the use of external batteries. With a 300-volt battery, the highest resistance range is  $10^{15}$  ohms full scale ( $6 \times 10^{16}$  ohms at the smallest meter division). The full battery voltage appears across the unknown resistance.

**Resistance Standards:**  $10^1$ ,  $10^2$ ,  $10^3$ ,  $10^4$ ,  $10^5$ ,  $10^6$ ,  $10^7$ ,  $10^8$ ,  $10^9$ ,  $10^{10}$ , and  $10^{11}$  ohms. The switch also includes "zero" and "infinity" positions. The  $10^1$ - and  $10^2$ -ohms resistors are wire wound and are accurate to  $\pm 0.25\%$ . The  $10^3$ -,  $10^4$ - and  $10^5$ -ohm resistors are of deposited-carbon construction and are accurate to  $\pm 1\%$ . The  $10^6$ ,  $10^7$ , and  $10^{11}$  resistors are carbon, have been treated to prevent adverse humidity effects, and are accurate to  $\pm 5\%$ . A switch position permits quick checking of the higher-resistance standards in terms of the wire-wound units.

**Input Resistance:** The input resistance is determined by the setting of the resistance standards switch. In the infinity position, it is approximately  $10^{14}$  ohms.

**Drift:** Less than 2 mv per hour after one-hour warmup.

**Output:** Voltage, current and resistance are indicated on a panel meter. Terminals are available for connecting a recorder (such as the Esterline-Angus 5-ma or 1-ma graphic recorder). The recorder can have a resistance of up to 1500 ohms.

**Input Capacitance:** Less than  $35 \mu\text{f}$ .

**Terminals:** The input is connected through an 874-type coaxial terminal assembly. In addition, there are three "low" terminals to provide versatility in guard and ground connections, as required, for example, in three-terminal network measurements.

**Input Switch:** A panel switch permits disconnection of the unknown without transient electrical disturbances in either the unknown or the measuring circuit.

**Input Insulation:** Entirely teflon or silicone-treated glass.

**Temperature, Humidity, Line Voltage Effects:** Negligible.

**Tube Complement:** One 5886 electrometer, one CK6418, one 6AN5, one 6AL5, one 6627, and three 0B2.

**Accessories Supplied:** One TYPE 874-411 Adaptor, one TYPE 1230-P1-300 Panel Adaptor Assembly, two TYPE 274-MB Plugs, one TYPE 274-SB Plug, spare fuses and TYPE CAP-35 Power Cord.

**Accessories Available:** TYPE 1230-P1 Component Shield.

**Mounting:** Aluminum front and rear panels finished in black-crackle lacquer and encased in an aluminum black-wrinkle-finished sleeve-like cabinet. The instrument is also available mounted inside a recorder case.

**Power Supply:** 105 to 125 (or 210 to 250) volts, 50 to 60 cycles. Power input is approximately 35 watts at 115 volts.

**Dimensions:** (height)  $13\frac{1}{4}$  x (width)  $7\frac{7}{8}$  x (depth) 9 inches, over-all.

**Net Weight:**  $15\frac{1}{4}$  lbs.

Type		Code Word	Price
1230-A	D-C Amplifier and Electrometer.....	MASON	\$440.00
1230-AE	D-C Amplifier and Electrometer in Esterline-Angus Case.....	MISTY	502.00
1230-P1	Component Shield.....	MANOR	40.00

PATENT NOTICE. See Notes 2 and 4, page viii.

Elementary schematics showing, left to right, the circuits for measuring current, resistance, and voltage. The batteries are symbolic only; the instrument is entirely a-c operated.

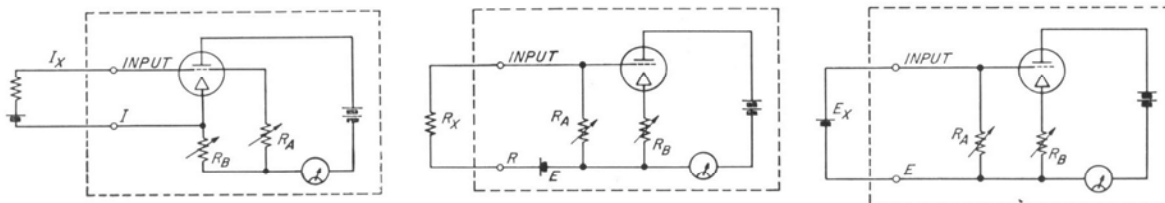

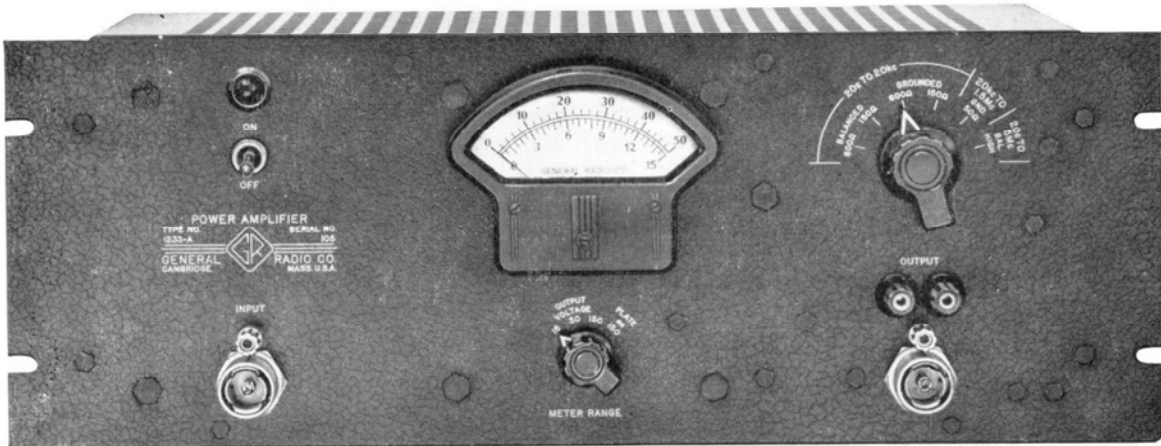

### TYPE 1233-A POWER AMPLIFIER

20 c to 20 kc      20 kc to 1.5 Mc      20 c to 3 Mc

**USES:** The wide frequency range and high power output of this amplifier make it adaptable to many uses in electronic and electro-acoustic laboratories. Typical uses are:

- Driving acoustic generators.
- Exciting antennas for radiation-pattern and impedance measurements.
- Amplifying received signals for operating remote modulation and frequency monitors.
- Amplifying weak signals for oscilloscope deflection.

**DESCRIPTION:** The excellent frequency response of this amplifier is obtained in three push-pull, broad-band circuits with series-peaked interstage couplings. The two power ranges use toroidal output transformers; the voltage-amplification range uses a series-peaked video-output network with gradual roll-off above 3 Mc. Ranges are selected by panel switch. Meter reads output volts and can be switched to read plate current of output tubes.

#### SPECIFICATIONS

**Input Voltage:** Less than 0.2 volt for full output.  
**Input Impedance:** 100,000 ohms in parallel with 37  $\mu\mu\text{f}$  (grounded).  
**Power Supply:** 105 to 125 (or 210 to 250) volts, 40 to

60 c; 120 watts at zero output; 140 watts maximum.  
**Voltmeter:** Full-wave-average type; 150, 50, and 15 volts f.s.; Accuracy  $\pm 5\%$ ; Impedance 15,000 ohms, compensated to 5 Mc.

Range Switch Position	Operating Freq. Range	OUTPUT Power* Voltage	Optimum Load Impedance	Rise Time	Distortion at Rated Output	Noise Level
20 c to 20 kc	20 c — 20 kc 50 c — 15 kc	8 watts 15 watts	600 or 150 $\Omega$		3%	60 db below 15 watts, or equivalent to 200 $\mu\text{v}$ input
20 kc to 1.5 Mc	20 kc — 1.5 Mc 20 kc — 0.5 Mc	8 watts 15 watts	50 $\Omega$ grounded		3%	70 db below 15 watts or equivalent to 63 $\mu\text{v}$ input
20 c to 3 Mc	20 c — 3 Mc	150 volts, peak-to-peak, bal; 50 volts grounded	CRO deflection plates; 1 M $\Omega$ , 36" leads	0.1 $\mu$ sec.	3%	0.6V, peak to peak, bal, or equivalent to 600 $\mu\text{v}$ p-t-p, input
Disconnected	Any single frequency, 20 c to 5 Mc	15 watts; with external tuned output transformer				

\*Rated output is obtainable at 105 volts line; output is greater for higher line voltages.

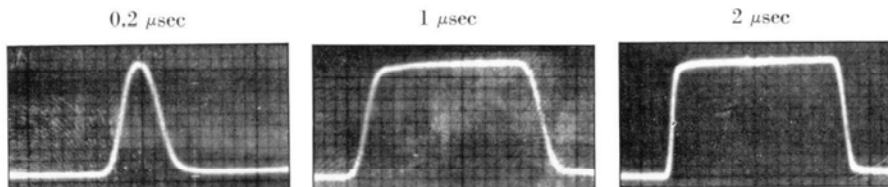

Output pulse waveforms 20c to 3 Mc range; input pulse rise time, 0.03  $\mu\text{sec}$ ; three pulse lengths shown.



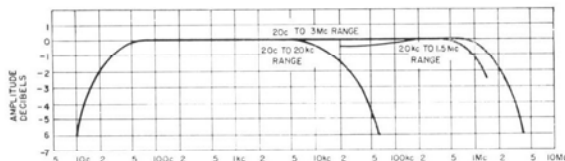

Typical response curves for the three amplifier ranges. The 20-cycle-to-3-megacycle range is given a smooth roll-off at the high end to assure good transient response.

**Frequency Response:** See plot.

**Phase Shift:** See plot.

**Tube Complement:** 2 — 6AC7    2 — 6AG7  
                                   2 — 807        1 — 6J6

**Terminals:** Input and output TYPE 874 Coaxial Terminals, with ground post for double-plug connection; TYPE 938 Binding Posts for balanced output.

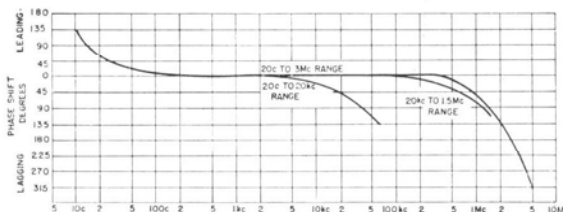

Phase Shift versus frequency for TYPE 1233-A Power Amplifier.

**Accessories Supplied:** Two TYPE 874-MB Double Plugs; two TYPE 874-C59 Cable Connectors; two spare line fuses; TYPE CAP-35 Power Cord.

**Dimensions:** Relay-rack panel, 19 x 7 inches; over-all, 19 3/8 x 15 1/2 x 7 1/2 inches.

**Net Weight:** 46 1/2 pounds.

Type	Code Word	Price
<b>1233-A</b>   Power Amplifier.....	ANGER	\$560.00

PATENT OFFICE. See Note 4, page viii.

### TYPE 1206-B UNIT AMPLIFIER

This well-designed, compact amplifier delivers 3 watts at audio and ultrasonic frequencies. It has many uses in the laboratory — as a bridge amplifier, a driver for low-power electronic and electro-acoustic devices, and as an amplifier for use with the TYPE 1210-B Unit Oscillator and other low-power oscillators.

The Unit Amplifier plugs conveniently into a Unit Power Supply (pages 144-146) and uses the single-ended push-pull circuit.\*

\* A. P. G. Peterson and D. B. Sinclair, "A Single-Ended Push-Pull Audio Amplifier," Proc. I.R.E., January, 1952, pp. 7-11.

**Power Output:** With 300-volt plate supply, 600-Ω load:  
 3 watts from 10 cycles to 50 kc.  
 1.5 watts from 5 cycles to 100 kc.  
 0.5 watts at 250 kc.

**Distortion:** Less than 1% harmonic distortion with 2 watts output (2% with 3 watts) into 600 ohms from 20 cycles to 40 kc.

**Pulse Response:** *No Load* 600Ω  
 Droop in 30-cycle square wave    15%    20%  
 Approx. Rise time: 50 v peak-to-peak    1 μsec.    2 μsec.  
   100 v peak-to-peak    2 μsec.    4 μsec.

Max. output, peak-to-peak magnitude: 260 v    120 v  
**Load Impedance:** 600 ohms optimum. Blocking capacitor is 100 μf. (Internal impedance about 100 ohms.)

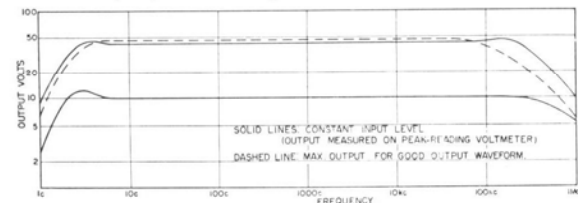

Type	Code Word	Price
<b>1206-B*</b>   Unit Amplifier.....	ARBOR	\$85.00
<b>1203-A</b>   Unit Power Supply.....	ALIVE	40.00
<b>480-P4U3</b>   Relay Rack Panel for above Amplifier and Power Supply.....	UNIPANCART	10.00

\* PATENT NOTICE. See Notes 1 and 8, page viii.



**Input Impedance:** 100,000 ohms in parallel with 35 μf.  
**Frequency Response:** Down less than 3 db at 2 cycles and 500 kc at 10 volts (or less) output with gain control set at maximum. See also power output specification.

**Voltage Gain:** Continuously adjustable. Maximum gain is 50 to 1, (34 db) with no load.

**A-C Hum in Output:** Less than 15 mv, rms, with TYPE 1203-A Unit Power Supply; less than 3 mv, rms, with TYPE 1201-A Unit Regulated Power Supply.

**Power Requirements:** 6.3 volts, 2.7a; 300 volts, 50 ma. TYPE 1203-A Unit Power Supply is recommended.

**Power Supply:** The amplifier plugs directly into any one of the Unit Power Supplies (pages 144-146). It can be permanently attached with bolts supplied to form a complete assembly.

**Accessories Supplied:** Multipoint connector.

**Tube Complement:** One 12AX7 and two 6W6-GT.

**Terminals:** Jack-top binding posts with standard 3/4-inch spacing.

**Mounting:** Black-crackle finished panel and sides. Aluminum cover finished with clear lacquer. Relay-rack panel available: see price table below.

**Dimensions:** (width) 9 7/8 x (height) 5 3/4 x (depth) 6 1/4 inches, over-all.

**Net Weight:** 4 pounds.

# IMPEDANCE-MEASURING INSTRUMENTS

## METHODS

For the measurement of all types of impedance, resistive or reactive, inductive or capacitive, at frequencies well up into the u-h-f band, null methods have proved to be the most acceptable on grounds of both precision and convenience. Most of the null methods used from dc to radio frequencies of the order of 100 megacycles are adaptations of the fundamental Wheatstone bridge circuit, although other types of networks which can be adjusted to give zero transmission for a particular configuration of circuit elements are sometimes used. Other systems, usually resonant circuits, using deflection-type instruments also have advantages for certain applications.

At very high frequencies where impedances can no longer be treated as lumped elements, coaxial-line techniques offer greater promise than bridge circuits made up of lumped elements, and null methods employing these techniques have been developed.

## DIRECT-CURRENT BRIDGES

The so-called Wheatstone bridge, Figure 1, has been used for over a century for the measurement of direct-current resistance and is still considered the fundamental circuit for the purpose. It measures an unknown resistance in terms of calibrated standards of resistance from the relationship

$$\frac{R_A}{R_B} = \frac{R_N}{R_P} \quad (1)$$

which is satisfied when the voltage across the detector terminals is zero.

The General Radio Company manufactures three d-c bridges using the Wheatstone circuit: (1) the TYPE 650-A Impedance Bridge, which includes a d-c resistance measuring circuit with a d-c galvanometer as the detector; (2) the TYPE 544-B Megohm Bridge, designed for the measurement of very high resistances, in which the necessary sensitivity

is obtained by using as a detector a vacuum-tube voltmeter with extremely high input resistance; and (3) the TYPE 1652-A Resistance Limit Bridge, designed primarily for production testing, but also capable of laboratory resistance measurements over a wide range.

## ALTERNATING-CURRENT BRIDGES

The basic circuit of Figure 1 is also applicable to a-c measurements. With impedances substituted for resistances, two conditions of balance must be satisfied simultaneously, one for the resistive component and one for the reactive component. The fundamental equations of balance can be written in either of the following forms:

$$R_N + jX_N = Z_A Z_P Y_B \quad (2)$$

$$G_N + jB_N = Y_A Y_P Z_B \quad (3)$$

Equation (2) is most convenient when it is desired to express the unknown in terms of its *impedance* components, while Equation (3) is used when the unknown is considered in terms of its *admittance* components. In order to satisfy these equations, at least one of the three arms *A*, *P*, or *B* must be complex.

The reactance  $X_N$  can be measured in terms of a similar reactance in an adjacent arm. Of the bridges described on the following pages, TYPES 716, 740, 1611, and 650 use this method for the measurement of capacitance, while TYPE 667 uses it for the measurement of inductance. In the TYPE 1604-B Comparison Bridge this method is adapted to the rapid measurement of resistors, capacitors, or inductors by comparison with a standard sample. The reactance of the unknown can also be measured in terms of an unlike reactance in the opposite arm. The TYPE 650 measures inductance in this manner, using a capacitor in the opposite arm as the standard.

The TYPE 1603-A Z-Y Bridge for audio frequencies and the TYPES 1606-A and 916-AL for radio frequencies employ a substitution technique in the circuit shown on page 36.

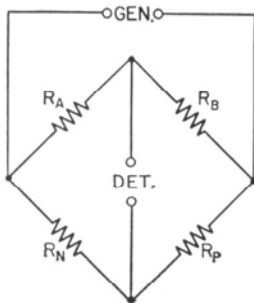

(Left) FIGURE 1. The general Wheatstone bridge circuit. (Right) FIGURE 2. Circuits for capacitance bridges in which like reactances,  $C_N$  and  $C_P$ , or unlike reactances,  $L_A$  and  $C_P$ , are compared.

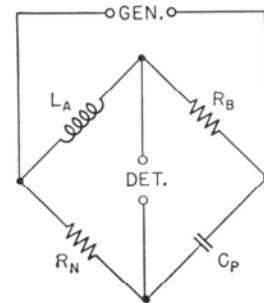
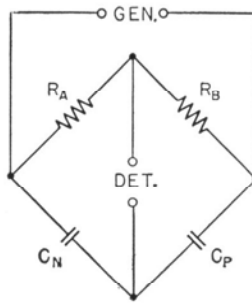



In the radio-frequency bridges the *capacitors* in the A and P arms are variable and measure the reactance and resistance, respectively, of an unknown connected in the P arm. In the TYPE 1603-A the *resistive* elements in A and P arm are variable and serve a dual purpose. For an unknown connected in parallel with the A arm, the variable resistors measure the conductance and susceptance components, while for an unknown connected in series with the P arm, these same resistors measure reactance and resistance. The circuit constants are so chosen that this bridge possesses the ability, unique among available a-c bridges, of balancing for any impedance presented to its terminals.

**Resistive Balance**

Four basic methods are in common use. These are (1) resistance in series with the standard reactance, (2) resistance in parallel with the standard reactance, (3) capacitance in parallel with a resistive arm, and (4) capacitance in series with a resistive arm.

The series-resistance method (1) is used in the TYPES 740-B, 1611-A, 667-A, and 650-A. The parallel-resistance method (2) is used for some of the circuits in the TYPE 650-A. The TYPE 1603-A uses both series and parallel resistance. The parallel capacitance method (3) is used in the TYPES 716-C, 1601-A, 1606-A, and 916-AL. As used in the TYPE 716-C, the circuit is commonly referred to as the Schering bridge, with the controls calibrated in capacitance and dissipation factor. The circuit used in the 1601, 1606, and 916-AL, although similar in configuration, is used in a different manner, with the controls calibrated in terms of resistance and reactance.

**Dissipation Factor and Storage Factor**

An important characteristic of an inductor or a capacitor is the ratio of resistance to reactance or of conductance to susceptance. This ratio is termed dissipation factor, *D*, and its reciprocal is storage factor, *Q*. These

FIGURE 3. Four basic methods of obtaining resistance balance.

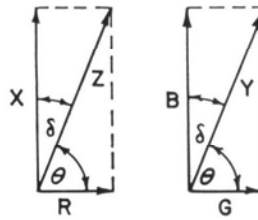
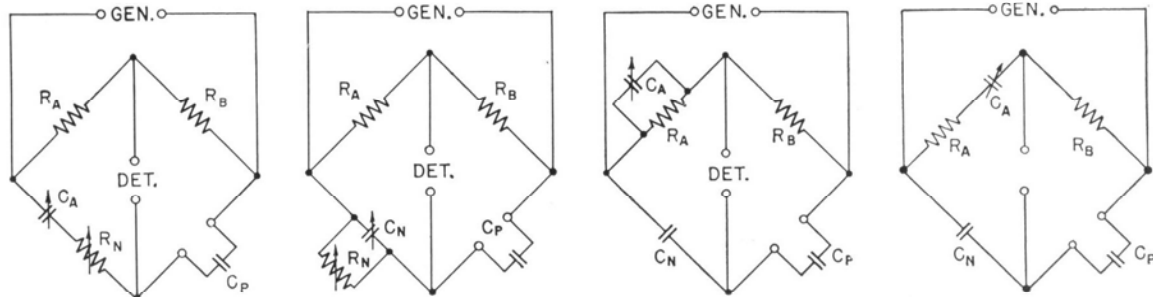

$$D = \cot \theta = \frac{R}{X} = \frac{G}{B}$$

$$\text{Power Factor} = \cos \theta = \frac{R}{Z}$$

$$Q = \tan \theta = \frac{X}{R} = \frac{B}{G}$$

FIGURE 4. Vector diagram showing the relations between factors *D* and *Q*, and angles  $\theta$  and  $\delta$ .

ratios are defined as follows:

$$D = \frac{1}{Q} = \frac{R}{X} = \frac{G}{B} \quad Q = \frac{1}{D} = \frac{X}{R} = \frac{B}{G} \quad (4)$$

where *R* and *X* are the series resistance and reactance, and *G* and *B* are the parallel conductance and susceptance of the impedance or admittance involved. Dissipation factor is directly proportional to the energy dissipated, and storage factor to the energy stored, per cycle. The relation of these factors to phase angle and loss angle is shown in Figure 4.

$$D = \frac{1}{Q} = \cot \theta = \tan \delta \quad (5)$$

Power factor is defined as

$$\text{P.F.} = \cos \theta = \sin \delta \quad (6)$$

and differs from dissipation factor by less than 1% when their values are less than 0.15.

FIGURE 5. Parallel-T circuit for measuring impedance at radio frequencies.

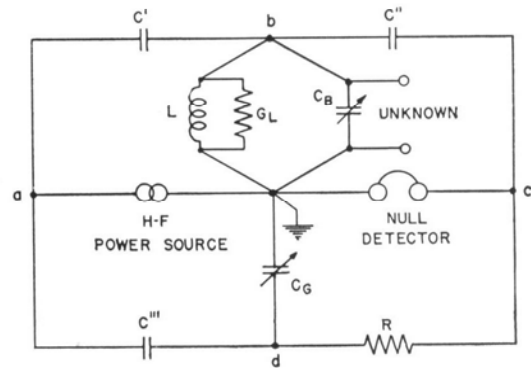



Dissipation factor is commonly used for capacitors and, to a lesser extent, for inductors because it varies directly with the loss. Storage factor  $Q$  is often used for inductors because it is a measure of the voltage step-up in a tuned circuit.

The bridge control for the resistive balance can be calibrated in dissipation factor, or in storage factor, for a given frequency. The TYPES 740 and 1611 have dials calibrated in dissipation factor at 60 cycles, and the TYPE 716 is direct reading at 100 cycles, 1, 10 and 100 kilocycles. The TYPE 650 reads directly the dissipation factor of capacitors and the storage factor of inductors, at 1000 cycles.

### OTHER NULL TRANSMISSION NETWORKS

#### The Twin-T

In addition to the bridge circuits described above there are a number of other networks that can be adjusted to give zero transmission. One of these, the Twin-T or Parallel-T illustrated in Figure 5, has proved to be of great value for admittance measurements at high radio frequencies. This circuit is used in the TYPE 821 for impedance measurements from 0.5 to 40 megacycles.

In this circuit the conductive component of the unknown is measured in terms of a fixed resistance and a variable capacitance, thus avoiding the errors inherent in variable resistors at high frequencies

#### The Admittance Meter

The upper-frequency limit of conventional bridge circuits using lumped-parameter elements is determined by the magnitude of the residual impedances of the elements and leads, and, in general, the corrections for

FIGURE 6. Schematic diagram of admittance meter circuit, with standards, generator, and null detector connected for admittance measurements.

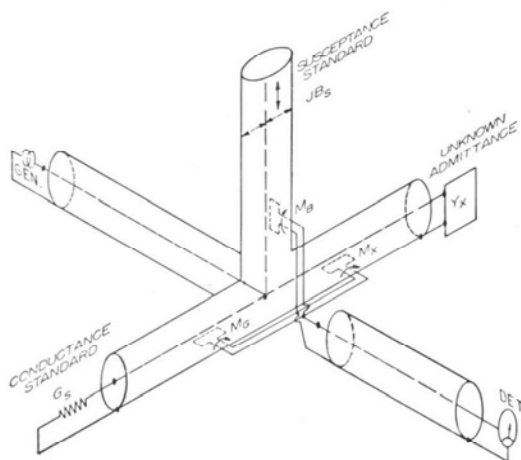

these become unmanageable at frequencies higher than about 150 megacycles, and circuits based on coaxial-line techniques are more satisfactory.

The TYPE 1602-B U-H-F Admittance Meter (see page 40) is a null device based on these techniques. Through adjustable loops, it samples the currents flowing in three coaxial lines fed from a common source at a common junction point and terminated, respectively, in the unknown element, a standard conductance, and a standard susceptance. The outputs of the loops are combined, and when the loops are properly oriented, the combined output becomes zero, so that a null balance is produced. Scales associated with the three loops give the value of the unknown directly.

### SLOTTED LINE

One of the important basic measuring instruments used as ultra-high frequencies is the slotted line, which can be used to determine the characteristics of an unknown impedance from the change in the standing-wave pattern of the electric field in the line produced by connecting the unknown to the load end of the line. The TYPE 874-LBA Slotted Line, a precise, but moderately priced instrument, with an operating range of 300 to 5000 megacycles is described in the section on U-H-F Coaxial Elements, page 45 et seq.

### VACUUM-TUBE BRIDGE

Using a null transmission circuit, the TYPE 561 Vacuum-Tube Bridge measures three fundamental vacuum-tube parameters: amplification factor, transconductance, and plate resistance. It can also measure the corresponding quantities for transistors. Each of the three coefficients is obtained in terms of the ratio of two 1000-cycle test voltages. A third voltage is used in a capacitance-balancing circuit.

### LIMIT BRIDGES AND COMPARATORS

Limit testing at several frequencies is made possible by the TYPE 1604-B Comparison Bridge and the TYPE 1605-A Impedance Comparator. The TYPE 1604 uses a null-balance circuit in which balance is achieved by adjustment of two dials, one of which varies the bridge ratio arms either side of unity, while the other changes the phase balance. Balance is indicated on a cathode-ray tube.

The Impedance Comparator, which is capable of extreme precision, indicates impedance difference and phase-angle difference directly on two panel meters.

This bridge, which uses a balanced trans-

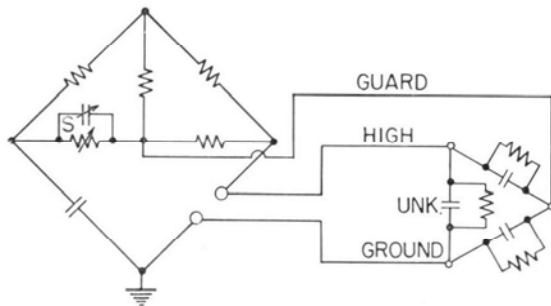

FIGURE 7. Elementary schematic circuit diagram of the TYPE 716-P4 Guard Circuit connected to the TYPE 716-C Capacitance Bridge showing the unknown capacitance and its terminal impedances.

former as the ratio arms, is as useful for laboratory measurements as it is in production testing.

### GUARD CIRCUIT

With the addition of a fifth point to a conventional four-arm bridge network, it becomes possible to measure the direct impedance between two points of a three-terminal network. Such a network is shown in Figure 8, with impedances between the fifth point and each of the four corners of the bridge. It can be shown that the network is in balance if *either* of the following conditions are met:

$$N = \frac{B}{P} = \frac{F}{H} \quad (1)$$

$$\frac{A}{B} = \frac{N}{P} = \frac{S}{T} \quad (2)$$

Obviously these conditions include the ordinary equation of balance of the four-arm network  $A-B-N-P$ .

Figure 7 shows the schematic diagram of the TYPE 716-P4 Guard Circuit, designed specifically for use with the 716-C Capacitance Bridge. In this circuit the guard point is brought to ground potential, as is the detector terminal. This particular type of guard circuit has been frequently referred to in literature as a Wagner Ground.

The use of the guard circuit permits the accurate measurement of the direct capacitance and dissipation factor between two terminals of a three-terminal network. One of the most important applications of such a measurement arises in the determination of the properties of dielectric materials. A guard electrode, which forms, with the two measuring electrodes, a three-terminal system, is often employed in such determinations to eliminate effects of variable lead parameters as temperature or other conditions are changed.

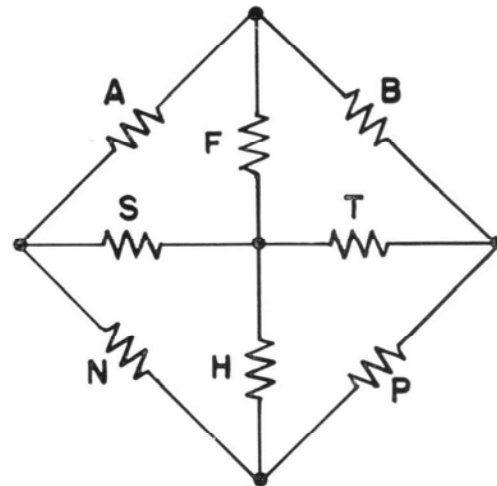

FIGURE 8. General bridge network with guard circuit, and unknown three-terminal impedance.

### DETECTORS

(See also the discussion of detectors on page 63)

To obtain the maximum precision of balance with any bridge or null-balance circuit, it is necessary to obtain a virtually complete null balance. With modern vacuum-tube circuits, however, sufficient sensitivity can be obtained to utilize all the potential precision of any null-balance network.

In some bridge circuits the balance is dependent upon frequency, and the value of the unknown impedance usually varies with frequency. Consequently, the presence of harmonics in the input to the bridge or their production in a non-linear impedance within the bridge may obscure the fundamental balance. A null balance may also be masked by the residual noise level of the oscillator and amplifier used. For these reasons it is usually advisable to employ a selective detector, tuned to the frequency at which it is desired to balance the bridge.

Conventional cathode-ray oscillographs and sensitive vacuum-tube voltmeters, although often used as bridge null detectors (as a result of being on hand when needed), are not always satisfactory for the purpose, for several reasons.

(1) Sensitivity: High sensitivity is needed to obtain a high precision of balance in order not to limit the accuracy of measurement. This is particularly important when a "sliding balance" condition exists, as when measuring inductors with low  $Q$  values. Even the better cathode-ray oscillographs have sensitivities little or no better than that of head



telephones without amplification at 1000 cycles. Sensitive vacuum-tube voltmeters are somewhat better. A good null detector, on the other hand, can detect levels of a few microvolts.

(2) Selectivity: In most instances it is good practice to use a null detector with a filter tuned to the frequency of measurement, and in many instances it is essential. Oscilloscopes and voltmeters are broad-band devices unable to discriminate well between a desired signal and hum, noise, or harmonics, all of which reduce precision of balance. General Radio null detectors have accessory filters especially designed for bridge measurements.

(3) Logarithmic amplitude response: This type of response is a great convenience and time-saver, since it reduces or eliminates completely any adjustment of null-detector gain during balance. General Radio bridge null detectors have logarithmic response, while oscilloscopes and voltmeters do not.

(4) Size complexity: An oscilloscope is unnecessarily large and complex for null detector work.

#### Audio and Sub-Audio Frequencies

The TYPE 1231-B Amplifier and Null Detector has a panel meter which can be used as a self-contained null indicator. This instrument can also be made selective by the addition of the TYPE 1231-P2, -P3, -P5, or TYPE 1951-A Tuned-Circuit Filters.

The TYPE 1212-A Unit Null Detector is somewhat less sensitive than the TYPE 1231-B but covers a much wider frequency range. It is usable up to 5 megacycles and has logarithmic response. TYPES 1951-A, 1212-P1, and P2 Filters are available for use with this detector.

The TYPE 736-A Wave Analyzer and the TYPE 760-A Sound Analyzer, in conjunction with an amplifier, are also satisfactory selective bridge detectors. The wave analyzer is particularly useful when extreme selectivity at the higher audio frequencies is required, while the sound analyzer provides good selectivity at low audio frequencies. For measurements over a wide range of frequencies, these instruments have the advantage of being continuously variable in frequency.

At audio frequencies, a vacuum-tube amplifier can also be used as a detector. Where a visual indication of balance is desired, as is necessary at frequencies below about 300 cycles, a rectifier-type voltmeter or a vacuum-tube voltmeter can be substituted for the head telephones.

#### Radio Frequencies

At radio frequencies, any well-designed commercial radio receiver can be used. Earphones, a loudspeaker, or a meter can be used as the actual balance indicator. Since radio receivers are inherently selective, the problem of radio-frequency harmonics is not significant. The receiver should be well shielded and should preferably have an r-f sensitivity control and provision for disconnecting the a-v-c circuit, in order to facilitate the approach to balance.

#### Ultra-High Frequencies

The most useful detector at ultra-high frequencies is the heterodyne TYPE DNT using a crystal mixer, a beating oscillator, and an i-f amplifier; see page 69.

#### POWER SOURCE

The main considerations in the selection of a power source for a-c bridge measurements are frequency stability, power output, and harmonic content.

The TYPES 740-B and 1611-A are designed for 60-cycle measurements and operate directly from the a-c power line. The TYPE 650-A has a self-contained 1000-cycle microphone hummer or the TYPE 650-P1 Amplifier-Oscillator, and no external oscillator is required unless it is desired to make measurements at frequencies other than 1000 cycles. All the other bridges described in this section require some type of external oscillator.

For single-frequency measurements at 400 and 1000 cycles, the TYPE 1214-A is very satisfactory. The TYPE 723-C Vacuum-Tube Fork is also satisfactory provided the power requirements are low.

When a continuously variable frequency is needed, the TYPE 1210-B Unit Oscillator, the TYPE 1304-A Beat-Frequency Oscillator, or the TYPE 1302-A Oscillator is recommended.

For measurements at radio frequencies with the TYPE 1606-A and TYPE 916-AL Radio-Frequency Bridges, or the TYPE 821-A Twin-T Impedance-Measuring Circuit, the TYPE 1330-A Bridge Oscillator or the TYPE 1211 Unit Oscillator should be used. For driving the TYPE 1601-A V-H-F Bridge and the TYPE 1602 U-H-F Admittance Meter, the TYPES 1208, 1209, 1218-A and 1215-A Unit Oscillators are excellent power sources.

#### Modulation

For radio-frequency measurements, it is preferable that the power source be unmodulated. Distortion in the modulating system,



frequency modulation, and asymmetrical sideband cutting in the receiver can produce appreciable errors in the balance point. In addition, maximum sensitivity is obtained with an unmodulated signal and an oscillating detector.

### CONNECTIONS

To achieve maximum freedom from electrostatic pickup, it is desirable to use shielded leads between generator and bridge and between bridge and detector. At audio and low-radio frequencies the reactance of the leads and terminals is unimportant, and electrostatic shielding is all that is necessary to prevent the introduction of extraneous voltages into the detector or the unknown impedance. At frequencies above a few megacycles, the reactance of the interconnecting leads also becomes a potential source of error. This is illustrated by the block diagram of Figure 9.

The small series inductance in the ground side of the generator cable is designated as  $L_G$ , similar inductances in the receiver cable and the common ground lead as  $L_R$  and  $L_M$ . The voltage drop in  $L_G$  produces a flow of current around the loop consisting of the cable sheath, the ground lead,  $L_M$ , and the ground capacitance of the oscillator. Similarly, current flows in the right-hand loop that includes  $L_R$ .

The voltage applied to the receiver has, therefore, two components, one from the bridge, the other from the drop across  $L_R$ . When a null point is reached, therefore, the bridge is out of balance by an amount necessary to cancel the effect of the extraneous voltage from  $L_R$ , that is, to make the vector sum of the bridge output voltage and the extraneous voltage equal to zero.

The error in measurement caused by this series inductance is one of the most serious encountered in null measurements at radio frequencies, but it can be avoided if coaxial terminals are used on both generator and receiver.

The TYPES 1606-A, 821-A, 916-AL, 1601-A, and 1602-B are equipped with TYPE 874 Co-

FIGURE 9. Showing how series inductance in the generator and detector leads can cause errors in measurement at radio frequencies.

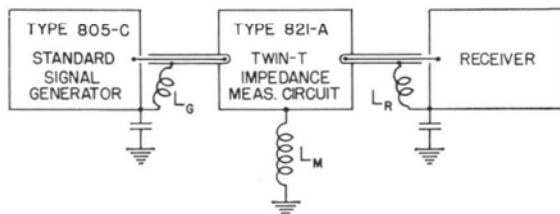

axial Terminals, and coaxial leads are supplied with these instruments to plug into the oscillator and detector, and a coaxial panel connector is supplied for mounting on any receiver used as a null detector.

### CLASSIFICATION

The table on the next two pages briefly summarizes the operating ranges, accuracy, and other pertinent data regarding the bridges listed in this section. From this table the most suitable instrument for any given measurement can be determined at a glance, while detailed specifications for each bridge are given on the subsequent pages.

FIGURE 10. Illustrating the shielding arrangement of the TYPE 716-C Capacitance Bridge. The ratio arms with their compensating capacitor, the dissipation factor capacitor, and the input transformer are all mounted on insulated subpanels and completely shielded. The shield is connected to the junction of the ratio arms, thereby placing its capacitance to ground across the detector terminals.

The shield around each transformer winding is connected to the winding, eliminating the terminal capacitances. A third shield, between the winding shields, is connected to the junction of the ratio arms. The capacitance between the third shield and the secondary winding shield is thus placed across the right-hand ratio arm, and its effect can be eliminated in the initial balance. Similarly, the capacitance between the primary shield and the interwinding shield goes across the detector terminals and does not affect the balance.

No capacitances are placed across the standard and unknown arms other than that of the leads and of the panel binding posts. The small amount placed across the standard capacitor is taken into account in the calibration, while that across the unknown terminals is one micromicrofarad.

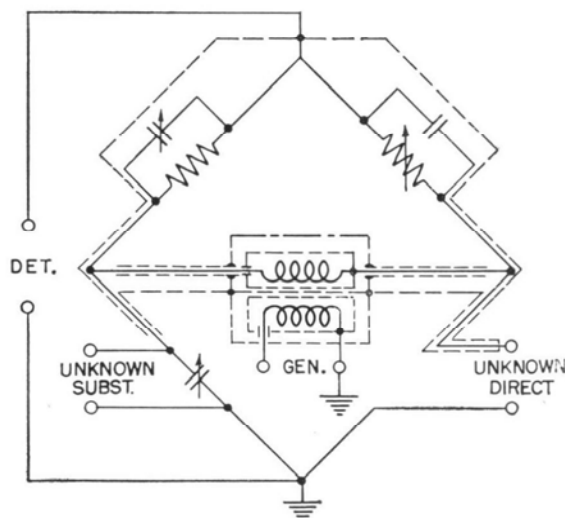



BRIDGES AND OTHER IMPEDANCE - MEASURING INSTRUMENTS

Type	Name	Measures	Range of Measurement	Accuracy	Measurement Frequency	Remarks	See Page
<b>DIRECT-CURRENT BRIDGES</b>							
1652-A	Resistance-Limit Bridge	R	1 to 1,111,111Ω	0.5% as limit bridge	dc	Equally useful as production-test or laboratory bridge. Self-contained.	14
		R	1 to 1,111,111Ω	0.25% by null method	dc		
544-B	Megohm Bridge	R	0.1 to 1,000,000MΩ	±3% up to 1000MΩ ±4% up to 100,000MΩ	dc	For measurements on high-valued resistors, insulation resistance of machines, appliances, cables and volume resistivity, etc. Self-contained.	16
<b>60-CYCLE BRIDGES</b>							
740-B	Capacitance Test Bridge	C	5 μμf to 1100 μf	±1%	60 c	Measures ungrounded capacitors. For production testing. Will measure polarized electrolytic capacitors of the type used in electronic circuits.	25
		D	0 to 50%	±1.5% of full scale	60 c		
1611-A	Capacitance Test Bridge	C	0 to 11,000 μf	±1%	60 c	For testing insulators, bushings, capacitors, cables, etc. Measures grounded capacitors.	26
		D	0 to 60%	±2%	60 c		
<b>AUDIO-FREQUENCY BRIDGES</b>							
650-AP and-A	Impedance Bridges	R	0.001Ω to 1MΩ	±1%	dc	Completely self-contained, general purpose, laboratory and production bridge. Belongs in every laboratory.	28
		L	1 μh to 100h	±2%	1 kc		
		C	1 μμf to 100 μf	±1%	1 kc		
		D	0.002 to 1	±20%	1 kc		
		Q	0.02 to 1000	±20%	1 kc		
1603-A	Z-Y Bridge	R & X	0 to = 1000Ω	±1%	20 c to 20 kc	Balances any unknown. Belongs in every laboratory.	34
		G & B	0 to = 1000 μhos	±1%	20 c to 20 kc		
716-C	Capacitance Bridge	C	100 μμf to 1 μf	±0.2% of full scale	1 kc	Direct-Reading	18
		C	100 μμf to 1000 μμf	±0.2% of full scale	0.1, 10, 100 kc		
		C	0.1 μμf to 1000 μμf	±0.2%	0.1, 1, 10, 100 kc		
		D	0.00002 to 0.56	±2%	0.1, 1, 10, 100 kc		
1611-AS2	Capacitance Test Bridge	C	0 to 11,000 μf	±1%	60 c and 120 c	Intended primarily for measuring electrolytic capacitors at 120c with applied D-C polarizing voltage.	27
		D	0 to 120% at 120c	±1%	60 c and 120 c		
667-A	Inductance Bridge	L	0.1 μh to 1 h	±0.2%	60 c to 10 kc	Widely used for measuring inductance of r-f coils. Measurement at 1 kc eliminates effect of distributed capacitance.	30





HIGH-FREQUENCY BRIDGES

Model	Bridge Type	Capacitance Range	Inductance Range	Resistance Range	Frequency Range	Accuracy	Model of
716-CS1	Capacitance Bridge	C	0.1 to 1100 $\mu\mu\text{f}$		0.5 to 3 Mc	$\pm 0.2\%$	High-frequency model of Type 716-C
916-A1	Radio-Frequency Bridge	D	0.0002 to 0.56		0.5 to 3 Mc	$\pm 2\%$	Measures low impedances, such as antennas, lines, and filters, simply and directly.
		X	$\pm 11,000\Omega$ ††		50 kc to 5 Mc	$\pm 2\%$	
1606-A	Radio-Frequency Bridge	R	0 to 1000 $\Omega$		50 kc to 5 Mc	$\pm 1\%$	Same uses as Type 916-A1 but for higher frequencies.
		X	$\pm 5000\Omega$ †		400 kc to 60 Mc	$\pm 2\%$	
821-A	Twin-T	R	0 to 1000 $\Omega$		400 kc to 60 Mc	$\pm 1\%$	Measures high impedances, parallel components, parallel resistance, resonant impedance.
		C	0 to 1000 $\mu\mu\text{f}$		460 kc to 40 Mc	$\pm 0.2\%$	
1601-A	V-H-F Bridge	G	0 to 100 $\mu\text{mhos}$ †		460 kc to 40 Mc	$\pm 2\%$	For measurements on either lumped or coaxial circuits.
		X	$\pm 200\Omega$ **		10 to 165 Mc	$\pm 5\%$	
1602-B	U-H-F Admittance Meter	R	0 to 200 $\Omega$		10 to 165 Mc	$\pm 2\%$	For measurement of coaxial lines, antennas, networks and components. Also measures VSWR.
		B	$\pm 0.2$ to $\pm 1000$ mmho		20 to 1500 Mc	$\pm 3\%$	
		G	0.2 to 1000 mmho		20 to 1500 Mc	$\pm 3\%$	
		X	1 $\Omega$ to 5000 $\Omega$		20 to 1500 Mc	$\pm 3\%$	
R	1 $\Omega$ to 5000 $\Omega$		20 to 1500 Mc	$\pm 3\%$			

COMPARISON BRIDGES

Model	Bridge Type	Accuracy	Frequency Range	Model of
1604-B	Comparison Bridge	$\Delta Z$	$\pm 5\%$ , $\pm 20\%$	Indicates on dials at balance percentage difference between unknown and a standard sample. Also gives instantaneous "go-no-go" indication on built-in oscilloscope with respect to any preset tolerances.
		$\Delta D$	$\pm 0.006$ at 400c $\pm 0.015$ at 1 kc $\pm 0.075$ at 5 kc Absolute impedance range: 2 $\Omega$ to 20 M $\Omega$	
1605-A	Impedance Comparator	$\Delta Z$	$\pm 0.3\%$ to $\pm 19\%$ , full scale	Indicates percent $\Delta Z$ and $\Delta\theta$ between unknown and a standard sample on two meters simultaneously without balancing. Can measure remote components, as in environmental tests, with recorder. For rapid and accurate laboratory and production testing.
		$\Delta\theta$	$\pm 0.003$ to $\pm 0.1$ radian, full scale Absolute impedance range: 2 $\Omega$ to 20 M $\Omega$	

OTHER INSTRUMENTS

Model	Instrument Type	Accuracy	Frequency Range	Model of
874-LBA	Slotted Line	VSWR	300 to 5000 Mc	The standard tool for thf impedance measurement.
561-D	Vacuum-Tube Bridge	$\mu$	1 kc	Also measures transistor low-frequency parameters. Adaptors are furnished for standard receiving tube bases and for transistors.
		$r_p$	1 kc	
		$g_m$	1 kc	

† At 1 Mc; Range varies inversely as the frequency. †† At 100 kc; Range varies inversely as the frequency. ‡ At 1 Mc; Range varies directly as the frequency. § At 100 Mc; Range varies inversely as the frequency.

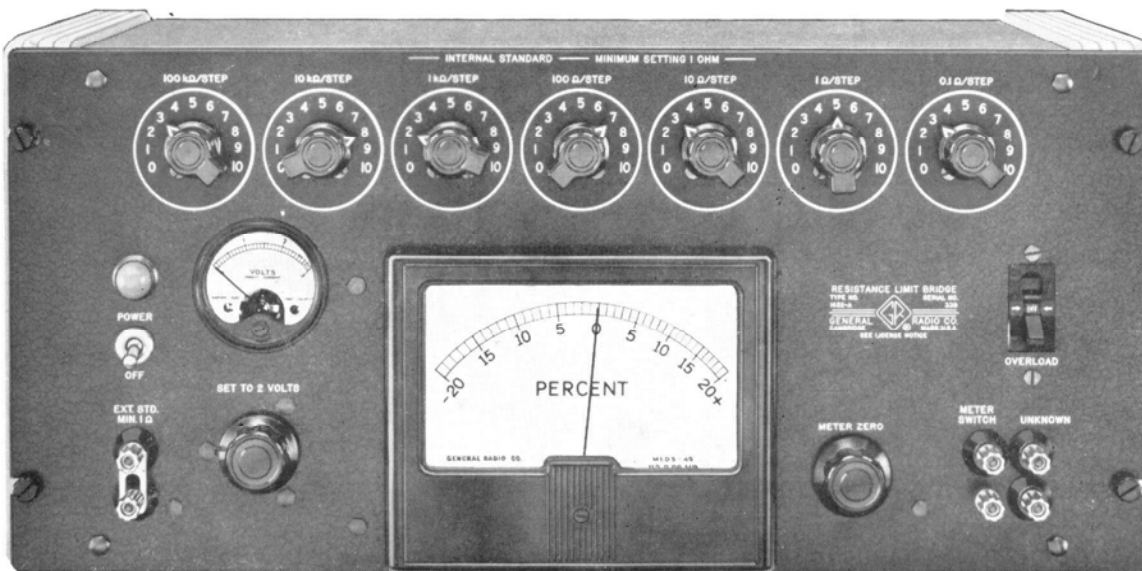

## TYPE 1652-A RESISTANCE LIMIT BRIDGE

### A LIMIT BRIDGE FOR RAPID TESTING A WHEATSTONE BRIDGE FOR THE LABORATORY

**USES:** The Resistance Limit Bridge is intended primarily for the production testing of resistors. It can be used to indicate on a meter the percentage deviation from an internal standard, to match pairs of resistors, and to compare resistors to a standard sample. It is also a precision Wheatstone bridge for general resistance measurement by the null method.

For manufacturers and users of resistors, this bridge offers an accurate and rapid means of separating resistors into tolerance classifications, and for selecting resistors to close tolerances. The manufacturer of electronic equipment can use it to advantage in matching pairs of resistors for operation in balanced circuits. Its accuracy is adequate for all but the most exacting requirements in the laboratory, and its ability to measure resistors as large as one megohm without the inconvenience of adding booster batteries makes it much more convenient than the ordinary decade bridge.

The bridge can also be adapted for use as the control unit in automatic sorting or inspecting. A relay, in conjunction with external amplification, can be substituted for the indicating meter, to actuate various types of rejection mechanisms. By adjustment of the sensitivity of the relay, end points can be established to determine tolerances such as  $\pm 5\%$ ,  $\pm 10\%$ , and  $\pm 20\%$ .

**DESCRIPTION:** The TYPE 1652-A Resistance Limit Bridge uses the conventional equal-arm Wheatstone bridge circuit. The bridge is supplied from a constant-voltage d-c source, and its indicating meter is calibrated in percentage difference between the unknown and the standard over a range of  $\pm 20\%$ .

A built-in standard consisting of seven TYPE 510 Decade Resistors is adjustable from one ohm to 1,111,111 ohms in 0.1-ohm steps.

Measurements are made simply by setting the standard to the nominal value of the resistor under test and reading the percentage difference on the meter. This test procedure can be greatly facilitated by the use of a test fixture into which the resistors can be plugged, and which can be operated in conjunction with a switch that shorts the meter circuit prior to removing the resistor from the jig. Panel terminals for such a switch are provided.

For the matching of resistors, the resistor to be matched is connected to terminals provided and the internal standard is set to zero.

Used as a conventional Wheatstone bridge, the circuit is balanced by adjusting the internal standard to equality with the unknown resistor, using the calibrated meter as a null indicator.

**FEATURES:** ➤ Rapid and accurate for limit tests.



- Extreme simplicity of operation. Large meter colored gold for 5% limits and silver for 10% limits.
- Equally useful for general resistance measurement.
- Covers a wide resistance range — one ohm to one megohm.

- No batteries required. Operates from 115-volt or 230-volt, 60-cycle line.
- Rugged construction and enclosed in welded aluminum cabinet.
- Accuracy — can measure resistors to an accuracy of  $\pm 0.25\%$ .
- Indicating meter can not be damaged by unbalance of bridge.

### SPECIFICATIONS

**Resistance Range:** As a limit bridge, 1 ohm to 1,111,111 ohms, with internal standard; for null measurement, 1 ohm to 1,111,111 ohms with internal standard; 1 ohm to 2 megohms with external standard.

**Limit Range:** Meter reads from  $-20\%$  to  $+20\%$ , with the standard RETMA tolerance range of  $\pm 5\%$  and  $\pm 10\%$  clearly indicated by gold and silver coloring, respectively.

**Accuracy:** As a limit bridge,  $\pm 0.5\%$  or better; for matching,  $\pm 0.2\%$ ; for null measurement, with internal standard,  $\pm 0.25\%$  above 10 ohms and  $\pm 0.4\%$  between 1 ohm and 10 ohms; with an external standard, from 1 ohm to 2 megohms  $\pm (0.2\% + \text{accuracy of standard})$ .

**Voltage Applied to Unknown:** The voltage across the unknown resistor is exactly one volt when the meter in-

dication is zero. As the meter indication varies from  $-20\%$  to  $+20\%$  the voltage across the unknown will vary from 0.89 volt to 1.10 volts.

**Power Supply:** 105 to 125 volts or 210 to 250 volts, 60 cycles. The power input is approximately 30 watts.

**Accessories Supplied:** Type CAP-35 Power Cord and spare fuses.

**Tube Complement:** One TYPE 6X4 and two TYPE 6SU7-GTY's. All are supplied with the instrument.

**Mounting:** The bridge is supplied for either relay rack or table mounting. Cabinet has black wrinkle finish.

**Dimensions:** Over-all, (width) 19 inches x (height)  $8\frac{3}{4}$  inches x (depth)  $10\frac{1}{2}$  inches.

**Net Weight:** 29 pounds.

Type		Code Word	Price
1652-AM	Resistance Limit Bridge (Cabinet Model)...	BUXOM	\$475.00
1652-AR	Resistance Limit Bridge (Relay Rack Model).	BADGE	475.00
1652-AQ1(M)	Resistance Limit Bridge (115 and 230 volts, 50 cycles).....	BUXOMPASHA	575.00
1652-AQ1(R)	Resistance Limit Bridge (115 and 230 volts, 50 cycles).....	BADGEPASHA	575.00

**MEGOHM BRIDGE:** A Wheatstone bridge for the megohm range, capable of measurements from 0.1 megohm to 1,000,000 megohms, is described on page 16.

**OTHER LIMIT BRIDGES:** The TYPE 1604-B Comparison Bridge (page 31) and the TYPE 1605-A Impedance Comparator (page 32) are designed for the rapid comparison of resistors, capacitors and inductors.

Schematic circuit diagram of the TYPE 1652-A Resistance Limit Bridge.

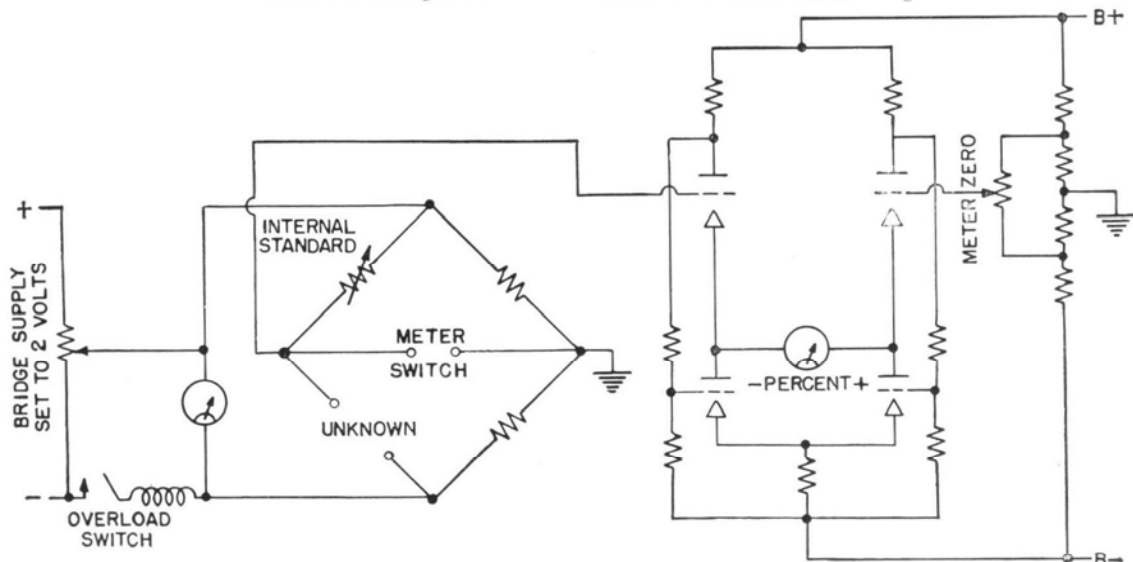



## TYPE 544-B MEGOHM BRIDGE



**USES:** The megohm bridge is very useful for measuring all types of resistances in the megohm ranges. These uses include not only the resistance of cartridge-type resistors, but also the insulation resistance of electrical machinery such as generators, motors, and transformers; of electrical equipment such as rheostats and household appliances; of single conductors, cables, and capacitors; of sufficiently long sections of high-voltage cables; of paper capacitors; and of slabs of insulating materials. Volume resistivity and its change with temperature and humidity can be determined. Guard connections are provided for the measurement of three-terminal resistors such as multi-wire cables, three-terminal capacitors, networks, and guarded specimens of insulating materials.

This bridge has been widely used for measuring the dielectric absorption effects in the insulation of electrical machinery, transformers, and cables. Charging-current curves can be easily obtained over time intervals from one second to many hours.

**DESCRIPTION:** The TYPE 544-B Megohm Bridge is a combination of Wheatstone bridge and vacuum-tube voltmeter.

The bridge is composed of the four arms, *A*, *B*, *N*, *P*, as shown for the OPERATE position in the diagram at the bottom of the next page, with the power applied across the arms, *A* and *B*, and the vacuum-tube voltmeter connected across the conjugate pairs, *A-N* and *B-P*. For checking the galvanometer zero, the tube is isolated from the bridge voltage as shown in the CHECK position, with the high resistors, *N* and *P*, connected to the grid exactly as in the OPERATE position. The effects of any voltages, alternating or direct, in the unknown resistor, *P*, and of any grid current of the tube will not appear in the bridge balance because they are balanced out in the zero adjustment. There is also a CHARGE position, in which the unknown resistor, *P*, is placed across the arm, *B*. This is valuable in measuring the resistance of large capacitors because full voltage is applied directly to the capacitor which can then charge at a maximum rate. The zero of the galvanometer can also be checked at any time without being affected by the residual charge in the capacitor.

**FEATURES:** ➤ The direct measurement of resistances up to 1,000,000 megohms is made possible by the use of a vacuum-tube detector, which absorbs a negligible amount of power.

➤ Constant fractional accuracy, regardless of setting, is obtained by using a resistance scale that is approximately logarithmic over one decade. The effective scale length for the range from 100,000 ohms to 10,000 megohms is 35 inches.

➤ The voltage applied to the unknown resistance is held approximately constant, regard-

Schematic circuit diagram of the megohm bridge.

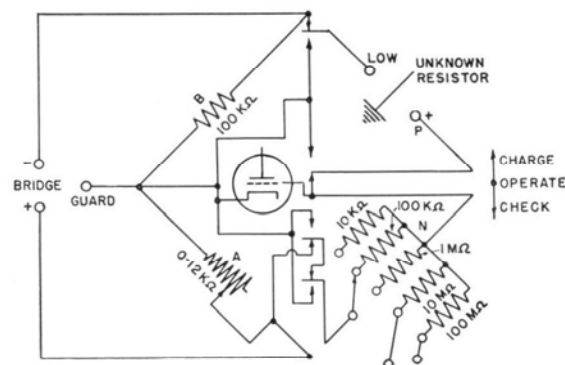



less of the value of the unknown resistance. This condition is necessary to measure insulation resistance properly.

➤ Voltage stabilization is used in the a-c power supply to prevent surges in charging current when the leakage resistance of capacitors is measured.

**SPECIFICATIONS**

**Range:** 0.1 megohm to 1,000,000 megohms, covered by a dial and a 5-position multiplier switch. A resistance of 1,000,000 megohms can be distinguished from infinity.

**Accuracy:** ±3% on the 0.1, 1, and 10 multipliers; ±4% on the 100 and 1000 multipliers. Above 10,000 megohms, the accuracy is essentially that with which the scale on the MEGOHMS dial can be read.

**Terminals:** All high-voltage terminals are insulated as a protection to the operator.

**Power Supply:** Two types of power supply are available: (1) an a-c unit delivering d-c test voltages of 500 volts and 100 volts to the bridge, and (2) a battery power supply of 90 volts. The a-c unit operates from a 105- to 125-volt (or 210- to 250-volt), 40- to 60-cycle line. The battery power supply consists of 1 No. 6 Dry Cell and 3 45-volt batteries. This supplies 45 volts for the tube anode and 90 volts for the test voltage.

**Power Input:** 60 watts at 115 volts, 60 cycles; with battery supply, approximate current requirements are 60 ma for cathode heaters and 7.5 ma for anode.

**External Bridge Voltage:** Terminals are provided so that the bridge voltage can be obtained from an external source if desired. Up to 500 volts can be applied.

**Tube Complement:** With battery power supply, a 1L4 detector tube is used; the 500-volt power supply uses a 6K7-G detector, a 6X5-G rectifier, a 5U4-G rectifier, and, in the voltage regulators, a 6J5-G, a 6K6-G, a 4A1 ballast tube, and two TYPE NE-48 neon lamps.

**Accessories Supplied:** Test probe. With a-c power supply,

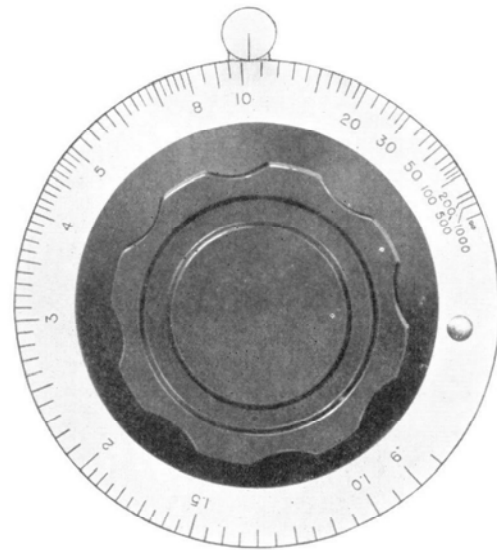

The MEGOHMS dial of TYPE 544-B Megohm Bridge. The scale is approximately logarithmic over the main decade from 1 to 10.

a TYPE CAP-35 Power Cord, spare fuses, and spare neon ballast tube. Batteries are supplied with the battery-operated model.

**Mounting:** Shielded oak cabinet with cover.

**Dimensions:** Cabinet with cover closed, (width) 8½ x (length) 22½ x (height) 8 inches, over-all.

**Net Weight:** With battery power supply, 29½ pounds; with a-c power supply, 25¾ pounds; TYPE 544-P10, 14¼ pounds; TYPE 544-P3, 11½ pounds.

Type		Code Word	Price
544-BA	Megohm Bridge, with A-C Power Supply...	AGREE	\$355.00
544-BB	Megohm Bridge, Battery Operated (Incl. Batteries).....	ALOOF	250.00
544-P3	A-C Power Supply Unit Only.....	AGREEAPACK	145.00
544-P10	Battery Power Supply Unit Only.....	ALOOFAPACK	40.00

Two direct-indicating instruments for measuring resistances in the megohm range are the TYPE 1862-B Megohmmeter, described on page 132, and the TYPE 1230-A D-C Amplifier and Electrometer, described on page 2.

These diagrams show the bridge connections for the three positions of the CHECK-OPERATE-CHARGE switch.

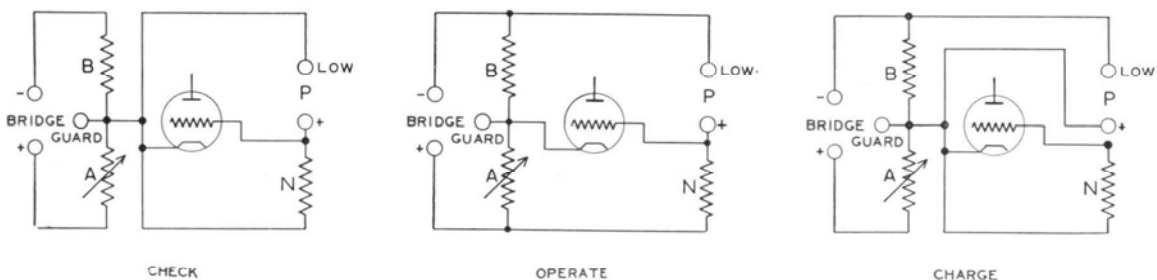

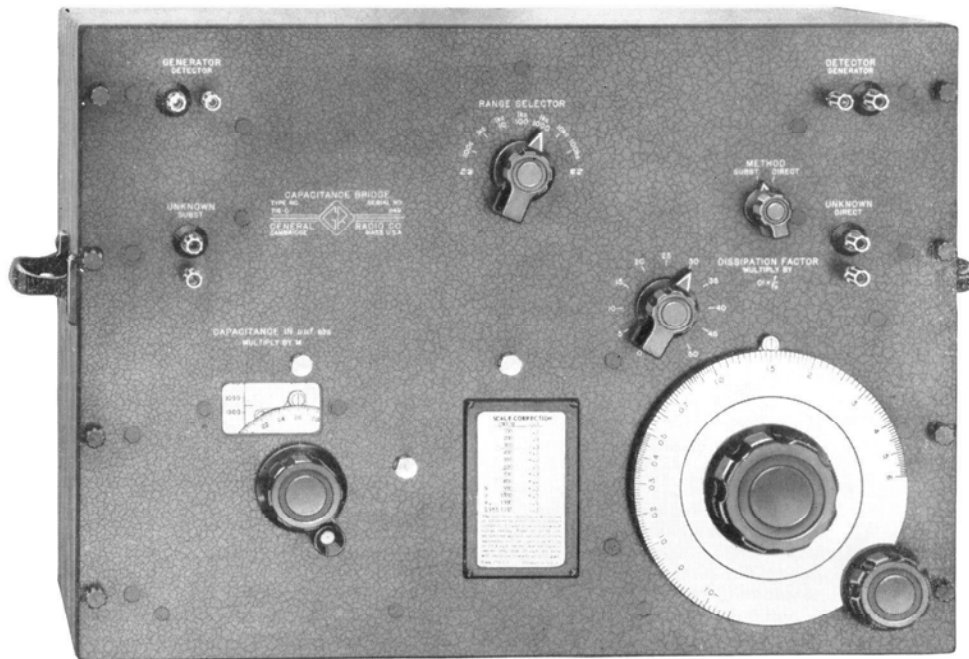

## TYPE 716-C CAPACITANCE BRIDGE

**USES:** This precise, direct-reading, capacitance bridge can be used for a wide variety of capacitance and dissipation-factor measurements. Within its scope are the determination of dielectric constant, dissipation factor, loss factor, phase angle, and other dielectric properties of insulating materials, as well as their change with such factors as frequency, temperature, and humidity.

In addition to direct-reading capacitance measurements, the bridge is capable of measuring other impedances by substitution methods. Among these are the inductance and storage factor of large inductors, up to several thousand henrys; the inductance and resistance of cables at frequencies up to 300 kc; the resistance and parallel capacitance of high-valued resistors, up to several thousand megohms; and capacitances up to several thousand microfarads.

By adding an external decade resistor, the bridge can be converted to a series- or parallel-resistance bridge, which latter is especially useful in measuring the resistance of electrolytes.

In the General Radio laboratories the TYPE 716 Capacitance Bridge is used for all capacitance standardization measurements. In production it is used for the testing and adjustment of all precision fixed capacitors.

**DESCRIPTION:** The TYPE 716-C Capacitance Bridge is a modified Schering bridge, direct

reading in capacitance at any frequency, and in dissipation factor at 100 cycles, and 1, 10, and 100 kilocycles.

A wide capacitance range at 1 kilocycle is obtained by four sets of ratio arms giving multiplying factors from 1 to 1000 in decade steps. The built-in standard is a TYPE 722 Precision Capacitor, calibrated to read directly in total capacitance. The zero capacitance across the unknown terminals is approximately  $1 \mu\mu\text{f}$ . All capacitances to ground of the input transformer and ratio arms are removed from the capacitance arms by placing them in a shielded compartment insulated from the grounded panel and connected to the junction of the ratio arms.

Dissipation factor is read directly from the dial setting of an air capacitor and from a decade-step capacitor connected across the fixed ratio arm. The 12-inch scale of the air capacitor is approximately logarithmic, so that, while having a maximum reading of 0.06, its smallest division near zero is 0.0001, thus allowing the estimation of 0.00002. The accuracy of the dissipation factor reading over the wide capacitance range is made possible by adding capacitance across the lower-valued ratio arms, so that the product  $RC$  of all the ratio arms is the same.

A schematic diagram of the bridge circuit is shown on page 11.



**FEATURES:** ➤ Wide capacitance and frequency ranges, high accuracy, and direct-reading dials are three very desirable features found in this bridge.

➤ Operation is simple, and both terminals and

controls are arranged for convenience and flexibility of operation.

➤ Operation up to 300 kilocycles is made possible by careful design of the shielded transformer to minimize leakage impedances and dielectric losses.

**SPECIFICATIONS**

**Ranges:** Direct reading: capacitance, 100  $\mu\mu\text{f}$  to 1  $\mu\text{f}$  at 1 kc; 100  $\mu\mu\text{f}$  to 1150  $\mu\mu\text{f}$  at 100 c, 10 kc, and 100 kc; dissipation factor, 0.00002 to 0.56.

Substitution Method: capacitance, 0.1  $\mu\mu\text{f}$  to 1050  $\mu\mu\text{f}$  with internal standard; to 1  $\mu\text{f}$  with external standards; dissipation factor,  $0.56 \times \frac{C'}{C_x}$  where  $C'$  is the capacitance of the standard capacitor and  $C_x$  that of the unknown.

**Accuracy:** Direct Reading: capacitance,  $\pm 0.1\%$  ( $\pm 1 \mu\mu\text{f}$  x capacitance multiplier setting) when the dissipation factor of the unknown is less than 0.01; dissipation factor,  $\pm 0.0005$  or  $\pm 2\%$  of dial reading, whichever is the larger, for values of  $D$  below 0.1.

Substitution Method: capacitance,  $\pm 0.2\%$  or  $\pm 2 \mu\mu\text{f}$ , whichever is the larger; dissipation factor,  $\pm 0.00005$  or  $\pm 2\%$  for the change in dissipation factor observed, when the change is less than 0.06.

A correction chart for the precision capacitor is supplied, giving scale corrections to 0.1  $\mu\mu\text{f}$  at multiples of 100  $\mu\mu\text{f}$ . By using these data substitution measurements can be made to  $\pm 0.1\%$  or  $\pm 0.8 \mu\mu\text{f}$ , whichever is the larger. For capacitance less than 25  $\mu\mu\text{f}$ , the error will decrease linearly to  $\pm 0.1 \mu\mu\text{f}$ . It is also possible to obtain, at an extra charge, a worm-correction calibration with which substitution measurements can be made to an accuracy of 0.1% or  $\pm 0.2 \mu\mu\text{f}$ , whichever is the larger.

When the dissipation factor of the unknown exceeds the limits given above, additional errors occur in both capacitance and dissipation-factor readings. Correction formulae are supplied, by means of which the accuracy given above can be maintained over all ranges of the bridge.

**Ratio Arms:** The arm across which the dissipation factor capacitor is normally connected at 1 kc has a resistance of 20,000 ohms. The other arm has four values, 20,000 ohms, 2000 ohms, 200 ohms, 20 ohms, providing the four multiplying factors 1, 10, 100, 1000. Suitable capacitors are placed across these arms so that the product  $RC$  is constant. At 100 c, 10 kc, and 100 kc the ratio arms are equal and have resistances of 200,000 ohms, 2000 ohms, and 200 ohms, respectively.

**Shielding:** Ratio arms, dissipation-factor capacitors, and shielded transformer are enclosed in an insulated shield. The UNKNOWN DIRECT terminals are shielded so that the zero capacitance across them is approximately 1  $\mu\mu\text{f}$ . A metal dust cover and the aluminum panel form a complete external shield.

**Frequency Range:** The accuracies given above hold for operating frequencies from 30 c to 300 kc, provided the operating frequency does not differ from the range selector frequency by more than a factor of three. Dissipation-factor readings must be corrected by multiplying the dial reading by the ratio of operating frequency to the range-selector frequency.

**Voltage:** Voltage applied at the GENERATOR terminals is fed to the bridge through a 1-to-1 shielded transformer. A maximum of 1 watt can be applied, allowing a maximum of 200 volts at 1 kc, but only 50 volts at 60 cycles. If generator and detector are interchanged, 750 volts can be applied.

**Temperature and Humidity:** Variations of temperature over normal ranges (65° F to 95° F) have no significant effect on the accuracy of the bridge, but precise measurements of *dissipation factor* should not be attempted when the bridge has been exposed to conditions of abnormally high relative humidity, unless it is dried by heat or a desiccant.

**Mounting:** The bridge is supplied either for mounting on a 19-inch relay rack or in a walnut cabinet.

**Accessories Required:** Oscillator and high impedance detector. For the power source the TYPE 1302-A Oscillator (page 108) is recommended. TYPE 1231-B Amplifier and Null Detector (page 64) with TYPE 1231-P Filters (page 65), or the TYPE 1212-A Unit Null Detector with TYPE 1951-A Filter (page 66) is recommended for use as the detector at audio frequencies. At low radio frequencies a radio receiver is satisfactory for aural null indications.

For substitution measurements, a balancing capacitor is needed. This may be a TYPE 722 Precision Capacitor or a fixed capacitor, TYPES 505, 509, 1401, pages 151-156. The TYPE 1610 Capacitance-Measuring Assembly which includes generator, detector, guard circuit and other accessories, is described on page 24.

**Accessories Supplied:** Two TYPE 274-NEO Shielded Patch Cords.

**Other Accessories Available:** For measurements on unguarded dielectric specimens, the TYPE 1690-A Dielectric Sample Holder (page 23) is recommended. For measurements of small capacitors having parallel side-by-side leads, the TYPE 1691-A Capacitor Test Fixture (page 21) is recommended.

**Dimensions:** (Length) 19 x (height) 14 x (depth) 9 inches, over-all.

**Net Weight:** 44½ pounds, relay-rack model; 54½ pounds, cabinet model.

Type		Code Word	Price
716-CR	For Relay-Rack Mounting.....	BONUS	\$545.00
716-CM	Mounted in Walnut Cabinet.....	BOSOM	580.00
	Worm-Correction Calibration for Internal Precision Capacitor.....	WORMY	50.00

**Type 1610 Capacitance Measuring Assembly**

A complete capacitance measuring assembly, including bridge, guard circuit, generator, and detector is listed on page 24.

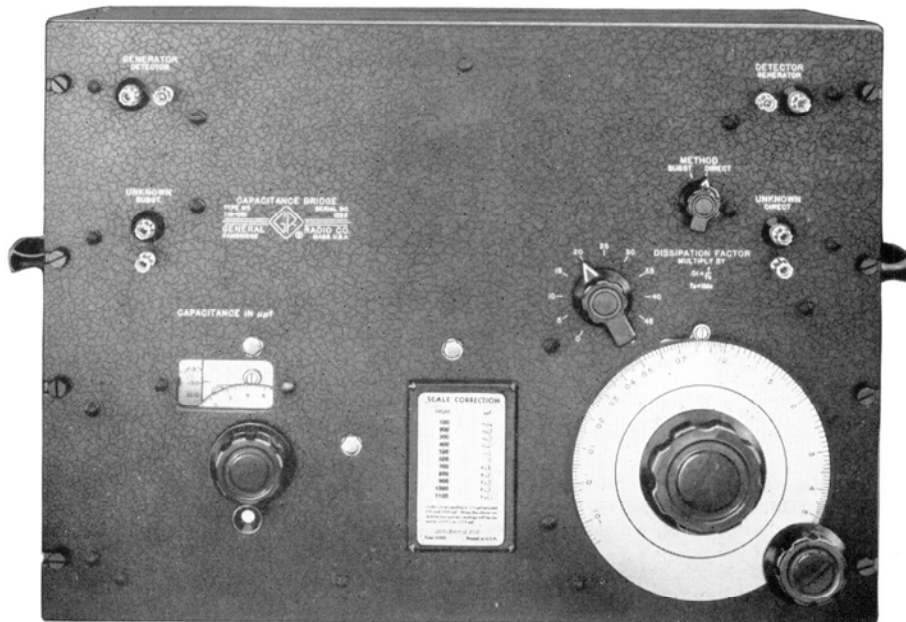

### TYPE 716-CS1 CAPACITANCE BRIDGE

Both commercial and military specifications for capacitors of 1000  $\mu\mu\text{f}$  and less call for measurements of capacitance and dissipation factor at a frequency of one megacycle. The TYPE 716-CS1 Capacitance Bridge has been designed specifically for these measurements. This bridge, a modification of the standard TYPE 716-C model, has unity ratio arms, a single capacitance range, and a limited frequency range. The standard capacitor is a TYPE 722-N, designed for use at 1 megacycle

and above, and the input transformer has been redesigned for high-frequency operation. With these changes, the bridge gives substantially the same performance at one megacycle as does the standard model at one kilocycle.

In addition to its use in testing capacitors, the TYPE 716-CS1 Capacitance Bridge is satisfactory for measuring dielectrics with the TYPE 1690-A Dielectric Sample Holder at the ASTM test frequency of one megacycle.

#### SPECIFICATIONS

**Capacitance Range:** Direct Method, 100 to 1150  $\mu\mu\text{f}$ ; Substitution Method, 0.1 to 1050  $\mu\mu\text{f}$ .

**Dissipation Factor Range:** Direct Method, 0.00002 to 0.56; Substitution Method,  $0.00002 \times \frac{C'}{C_x}$  to  $0.56 \times \frac{C'}{C_x}$ ,

where  $C'$  is the capacitance of the standard capacitor and  $C_x$  that of the unknown.

**Frequency Range:** Calibrated for one megacycle, the bridge operates satisfactorily at frequencies between 0.5 and 3 megacycles.

**Accuracy:** At one megacycle, the bridge is adjusted to have the same accuracy as the standard TYPE 716-C at low frequencies. This same accuracy can be obtained at other frequencies between 0.5 Mc and 3 Mc, if corrections are made for the effects of residual impedance.

**Accessories Required:** Oscillator and detector. Any of the following is satisfactory as the oscillator: TYPE 1330-A Bridge Oscillator (page 110); TYPE 1211-B Unit Oscillator with unit power supply (page 113), TYPES

1001-A and 805-C Standard-Signal Generators. For the detector at 1 Mc the TYPE 1212-A Unit Null Detector (page 66) with TYPE 1212-P2 One-Megacycle Filter and Unit Power Supply is recommended. For operation at frequencies other than 1 Mc, a well-shielded communications receiver should be used.

For substitution measurements, a balancing capacitor is needed. This may be a fixed TYPE 505, 509, or 1401 Capacitor (pages 154 to 156) or a variable TYPE 722 Precision Capacitor (page 151).

**Accessories Supplied:** Two TYPE 874-R32A Cables.

**Other Accessories Available:** For measurements on unguarded dielectric specimens, the TYPE 1690-A Dielectric Sample Holder (page 23) is recommended. For measurements of small capacitors having parallel, side-by-side leads, the TYPE 1691-A Capacitor Test Fixture (page 21) is recommended.

Other specifications are the same as those for the standard TYPE 716-C.

Type	Code Word	Price
716-CMS1	Capacitance Bridge (Mounted in Cabinet) ..	\$580.00
716-CRS1	Capacitance Bridge For Relay-Rack Mounting) .....	545.00
	BOGEY	
	BACON	





## TYPE 1691-A CAPACITOR TEST FIXTURE



(Above) View of the Type 1691-A Capacitor Test Fixture. (Right) View showing disc-type ceramic capacitor inserted in fixture.

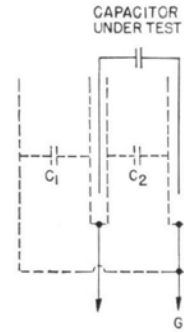

$$C_0 = C_1 + C_2 = 8.7 \mu\text{f}$$

Sketch showing the nature and magnitude of the zero capacitance. This capacitance does not enter the measurement when a substitution method is used.

**USES:** In the measurement of small capacitors, the results can be affected by the method of attaching the wire leads to the measuring instrument. This fixture assures reproducible results for capacitors having closely spaced parallel leads, by providing a standard method of attachment that eliminates variable lead capacitance. It is particularly useful with the TYPE 716-CS1 Capacitance Bridge in the

measurement of disc-ceramic capacitors at one megacycle.

**DESCRIPTION:** The fixture consists of two hollow shields, into which the test capacitor leads are fully inserted and held by spring clips, surrounded by another shield. Two banana plugs allow the fixture to be plugged into the measuring instrument. Losses are negligible, owing to the use of Teflon insulation.

### SPECIFICATIONS

**Zero Capacitance:**  $9 \pm 1$  micromicrofarads.  
**Terminals:** TYPE 274 Plugs on  $\frac{3}{4}$ -inch spacing.  
**Insulation:** Teflon.

**Dimensions:**  $1\frac{1}{2} \times 1\frac{1}{2} \times 2\frac{1}{2}$  inches, over-all, including plugs.  
**Net Weight:** 4 ounces.

Type	Code Word	Price
1691-A   Capacitor Test Fixture.....	EDICT	\$22.50

The plugs on the test fixture easily fit into the terminals of General Radio bridges or into other equipment having jack-top binding posts, spaced  $\frac{3}{4}$  inch. The bridge shown here is a Type 1611-A Capacitance Test Bridge, and the capacitor is a tubular paper type.

The Capacitor Test Fixture will accept all of the types of capacitors shown here.

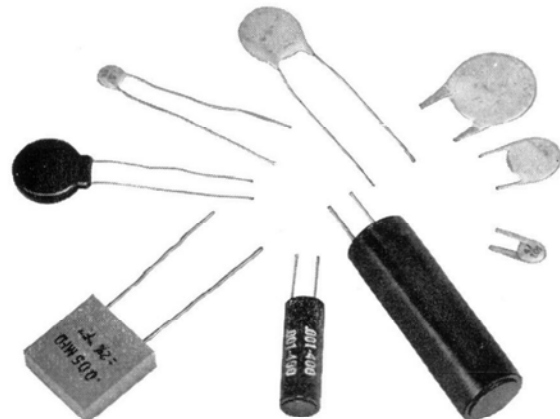
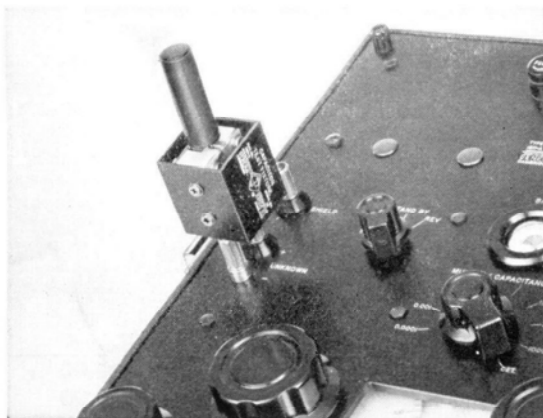



## TYPE 716-P4 GUARD CIRCUIT



**USES:** The Guard Circuit is designed for use with the TYPE 716-C Capacitance Bridge to facilitate the measurement of guarded dielectric samples and of other small capacitances where a three-terminal measurement is necessary. It is particularly useful for the measurement of components and materials over wide ranges of temperature and humidity, because it eliminates from the measurement the effects of the leads from the bridge to the sample in its conditioning apparatus, and permits the same accuracy of measurement that would be obtained if the sample were positioned directly at the bridge terminals.

**DESCRIPTION:** A basic schematic diagram of the capacitance bridge with guard circuit is shown on page 9. The guard arms *S* and *T* make it possible to balance any combination of capacitance and loss normally encountered in the terminal impedance of the unknown. The impedance of *S* and *T* is relatively high compared to the ratio arms of the bridge, which makes the guard-circuit balance less critical than it would be if both sets of arms

were of the same order of magnitude. The coupling circuit, *F*, consisting of a pair of adjustable resistors, permits partial balancing of the guard-to-ground terminal impedance thus facilitating the balance of arms *S* and *T*.

The circuit and switching are arranged for either direct reading or substitution methods. When measurements are to be made by substitution methods, i.e., by the precision capacitor of the bridge, it is necessary to connect a balancing capacitor in the adjacent arm of the bridge. A variable air capacitor (SUBST. CAPACITOR) with a maximum capacitance of 1150  $\mu\text{f}$  is built into the guard circuit for this purpose. Appropriately shielded and guarded switching is provided for connecting or disconnecting this capacitor as required. Thus the only external connection required is that to the unknown itself, whether direct-reading or substitution methods are employed.

Four pairs of ratio arms are provided in the bridge, for direct-reading operation at 100 cycles, 1 kc, 10 kc, and 100 kc. Correspondingly, four sets of resistive guard arms are provided in the guard circuit, selected by a panel switch. Four adjustable resistors are provided, with the switching so arranged that they are used in pairs for each switch setting, one "coarse" and one "fine" adjustment.

**FEATURES:** ➤ Makes possible three-terminal capacitance measurements with the TYPE 716-C Capacitance Bridge.

- Wide frequency range.
- Coupling circuit facilitates guard balance.
- Careful shielding assures accuracy of measurement.
- Connections are so arranged that bridge can also be used for two-terminal measurements.
- Guard cable included for connection to sample.

### SPECIFICATIONS

**Capacitance Range:** Designed for use with the x1 multiplier ranges of the TYPE 716-C Capacitance Bridge, i.e., a range of 0-1050  $\mu\text{f}$ . The range can be extended by adding external capacitance to the standard arm of the bridge.

**Frequency Range:** Corresponds to that of TYPE 716-C.

**Guard Balance Capacitor:** Any value of capacitance between the guard point and the high measuring terminal up to 1000  $\mu\text{f}$  can be balanced out.

**Mounting:** Available in two models: TYPE 716-P4M in

walnut cabinet matching cabinet of TYPE 716-CM; TYPE 716-P4R for relay-rack mounting. Leads are arranged for placing the guard circuit directly above the bridge.

**Accessories Supplied:** One TYPE 874-Q2 Coaxial Adaptor. One TYPE 838-B Alligator Clip.

**Net Weight:** TYPE 716-P4R, 17 lbs.; TYPE 716-P4M, 23 lbs.

**Dimensions:** 19 x 8 $\frac{3}{4}$  x 9 $\frac{1}{8}$  inches.

Type	Code Word	Price
716-P4M	BOSOMGUARD	\$315.00
716-P4R	BONUSGUARD	295.00

PATENT NOTICE. See Note 4, page viii.



## TYPE 1690-A DIELECTRIC SAMPLE HOLDER



**USES:** The TYPE 1690-A Dielectric Sample Holder is a micrometer-driven sample holder of the Hartshorn type,\* intended primarily for measurement of dielectric constant and dissipation factors of specimens of dielectric materials in the form of standard ASTM 2-inch diameter discs. It is suitable for any flat sample whose largest dimension is not greater than 2 inches and thickness not greater than 0.3 inch. It can be used, for example, with resonant circuits for susceptance-variation or frequency-variation measurements, with the TYPE 716-C Capacitance Bridge or the TYPE 821-A Twin-T; with the TYPE 874-LBA Slotted Line; or with the TYPE 1602-B Admittance Meter.

**DESCRIPTION:** A precision micrometer screw drives the movable grounded electrode with respect to a fixed insulated electrode. The screw adjustment control is a large instrument knob, in contrast to the small thimble employed in the usual machinist's micrometer. Attached to the knob is an accurately divided drum which indicates the spacing between electrodes. The micrometer screw is electrically shunted by a metal bellows, assuring positive low-resistance connection at all times. A release

mechanism is incorporated in the design of the movable electrode, so that when full positive contact is made between the two electrodes, the drive disengages, thus protecting the mechanism against mechanical stress. The same design feature also provides better contact between electrodes and specimens when the surfaces of the latter are not exactly parallel, since the movable electrode will adjust itself to the plane of the specimen surface.

A vernier capacitor with a capacitance range of 5  $\mu\mu\text{f}$  is also provided, for use in determining capacitance increments in the susceptance-variation method. This capacitor is of the cylindrical type, the movable cylinder being a precision micrometer screw. Ten turns of the screw cover the range of 5  $\mu\mu\text{f}$ , and the drum attached to the screw is accurately divided into 50 divisions, each corresponding to .01  $\mu\mu\text{f}$ .

The assembly is mounted in a rugged aluminum casting, which shields it on four sides. The shielding is completed by two removable cover plates, which permit access to the electrodes.

Connection to the electrodes may be made by TYPE 874 Coaxial Connectors or by TYPE 274 Pin Connectors. Adaptors are provided for mounting the TYPE 1590 Dielectric Sample Holder on the TYPE 716-C Bridge and on the TYPE 821-A Twin-T. An additional adaptor for connection to the TYPE 874-LBA Slotted Line and TYPE 1602 Admittance Meter is also available. The arrangement of the terminals is such that the holder can be mounted on a bridge with the panel in either the horizontal or vertical direction.

**FEATURES:** ➤ A dielectric specimen can be measured over a wide range of frequencies using the same holder but different measuring circuits.

- Corrections for edge fringing and stray capacitance are taken care of by the calibration.
- Rigid casting supports entire structure.
- Large easily read dials.
- Complete shielding.
- Flexibility — can be used with a number of different bridges or other measuring circuits.
- Precision calibration provided.
- "Floating" electrode protects precision drive against injury.

\*L. Hartshorn and W. H. Ward. Proceedings of the Institution of Electrical Engineers, v. 79, pp. 597-609 (1936).

### SPECIFICATIONS

**Electrodes:** Diameter, 2.000 inches  $\pm 0.0025$ . Surfaces are ground optically flat within a few wavelengths.

**Electrode Spacing:** Adjustable from zero to 0.3-inch maximum. The spacing is indicated directly by the micrometer reading in mils.

**Vernier:** Incremental capacitance is 5  $\mu\mu\text{f}$ , nominal.

**Calibration:** For the main capacitor, a chart is provided giving the calculated air capacitance as a function of spacing. A correction curve is also provided with each holder, giving the measured deviations from calculated values over the range from 300 mils to 10 mils spacing. In accordance with recommended ASTM practice, this calibration is referred to the calculated geometric value at a spacing of 100 mils.

For the vernier capacitor, a correction chart is provided, from which capacitance differences can be determined to an accuracy of  $\pm 0.004 \mu\mu\text{f}$ .

**Zero Capacitance:** Approximately 11  $\mu\mu\text{f}$ .

**Frequency:** This type of specimen holder introduces no

significant error at frequencies below 100 Mc. The technique of its use at higher frequencies has not been firmly established, but satisfactory results can be obtained for many types of measurements.

**Accessories Supplied:** TYPE 1690-P1 Adaptor Assembly for mounting to the TYPES 716-C Capacitance Bridge and the TYPE 821-A Twin-T. Hardware is supplied for mounting sample holder on TYPES 740-B, 1611-A, 1604-B, 544-B Bridges and TYPE 1862-B Megohm-meter.

**Accessories Available:** TYPE 1690-P2 Adaptor Assembly for connecting to TYPE 874-LBA Slotted Line or TYPE 1602 Admittance Meter.

**Mounting:** Supplied with a wooden carrying case. A drawer in the case provides storage for hardware, and a spring clip holds the calibrations, which are mounted in aluminum holders.

**Dimensions:** Over-all, mounted on adaptor,  $6\frac{1}{4} \times 5\frac{3}{4} \times 4\frac{1}{2}$  inches.

**Net Weight:** 3 $\frac{3}{4}$  pounds.

Type		Code Word	Price
1690-A	Dielectric Sample Holder.....	LOYAL	\$435.00
1690-P2	Adaptor Assembly..... (for Type 874-LBA Slotted Line)	LOYALMOUNT	20.00

PATENT NOTICE. See Note 4, page viii.



## TYPE 1610-A CAPACITANCE MEASURING ASSEMBLY

**USES:** The TYPE 1610-A Capacitance Measuring Assembly is a conveniently arranged unit containing complete equipment for highly precise measurement of capacitance and dissipation factor. Both two-terminal and three-terminal capacitances (two-terminal capacitances only with TYPE 1610-A2, see below) can be measured, either by direct or substitution methods, over the frequency range from 30 cycles to 100 kilocycles. In addition, inductance, storage factor, and resistance can be measured by substitution methods.

The guard circuit included as part of the 1610-A Assembly also permits the measurement of two-terminal capacitance at a considerable distance from the unit with the same precision that could be obtained with the unknown located at the bridge terminals.

**DESCRIPTION:** The TYPE 1610-A consists of:

- 1 TYPE 716-C Capacitance Bridge
- 1 TYPE 716-P4 Guard Circuit.
- 1 TYPE 1302-A Oscillator.
- 1 TYPE 1231-BRFA Amplifier and Null Detector (includes 1 TYPE 1231-P5 Filter)
- Rack cabinet and connecting cables.

The TYPE 1610-A2 is identical except the TYPE 716-P4 Guard Circuit is omitted and a blank panel substituted.

Complete descriptions of each of the five instruments indicated above can be found on pages 18, 22, 64, 65, and 108 respectively of this catalog.

The oscillator frequency range is from 10 cycles to 100 kc. The filter in the assembly is tuned to 11 fixed frequencies as selected by a switch, and any other frequency in the range from 20c to 100 ke with the addition of external capacitance.

**FEATURES:** ➤ Complete assembly for direct and substitution capacitance measurements,

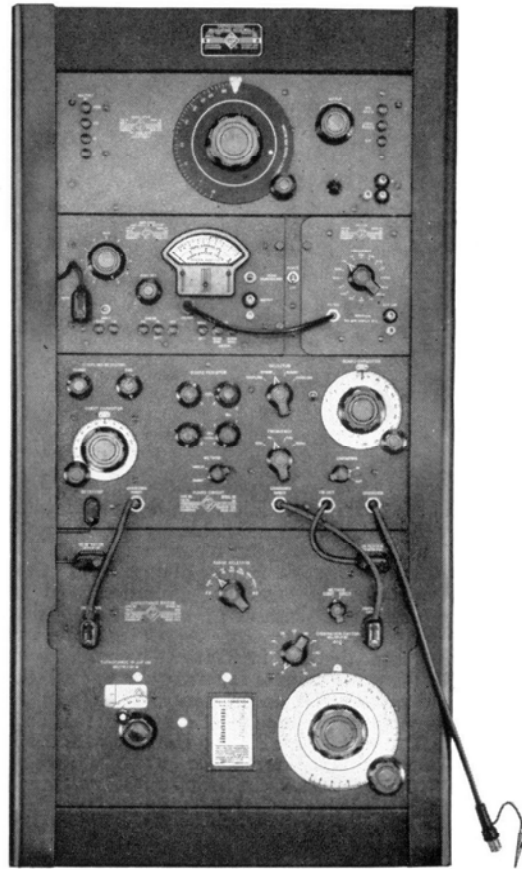

two-terminal or three-terminal, from 30c to 100kc.

➤ Instruments can be used separately without electrical or mechanical changes.

➤ TYPE 1690-A Dielectric Sample Holder can be mounted directly on Capacitance Bridge.

### SPECIFICATIONS

See specifications for TYPE 716-C Capacitance Bridge, TYPE 716-P4 Guard Circuit, TYPE 1231-BRFA Amplifier and Null Detector (includes TYPE 1231-P5 Filter), and TYPE 1302-A Oscillator.

**Accessories Required:** None, except a balancing capacitor for substitution measurements when the Guard Circuit is not used. This may be the TYPE 722-D Precision Capacitor (page 151), the TYPE 509 Standard Capacitor (page 156), or the TYPE 505 Fixed Mica Capacitor (page 155).

**Accessories Supplied:** Necessary cables, adaptor, alligator clip, and spare fuses.

**Accessories Available:** For measurements on unguarded dielectric specimens, the TYPE 1690-A Dielectric Sample Holder (page 23) is recommended.

**Dimensions:** (Height) 43 x (width) 22½ x (depth) 20 inches, over-all.

**Net Weight:** 202½ pounds for TYPE 1610-A, 180 pounds for TYPE 1610-A2.

Type		Code Word	Price
1610-A	Capacitance Measuring Assembly.....	SEDAN	\$2030.00
1610-A2	Capacitance Measuring Assembly (less Guard Circuit).....	SABER	1735.00

PATENT NOTICE. See Notes 1, 2, and 9, page viii.



## TYPE 740-B CAPACITANCE TEST BRIDGE



**USES:** The TYPE 740-B Capacitance Test Bridge is a 60-cycle capacitance and dissipation-factor bridge for use in both laboratory and production testing of paper, mica, and electrolytic capacitors. The capacitor manufacturer can use it for production tests, the capacitor user for acceptance tests. It is particularly useful in testing polarized electrolytic capacitors, because the test conditions approximate the normal operating conditions of use.

**DESCRIPTION:** The circuit used in this instrument is that of a series-resistance capacitance bridge. It is similar to the capacitance portion of the TYPE 650-A Impedance Bridge, but adapted for 60-cycle use. One ratio arm is variable in decade steps, and the other is

continuously variable and calibrated directly in capacitance.

The TYPE 740-B Capacitance Test Bridge is a simpler instrument than the TYPE 1611-A, with a smaller capacitance range and lacking some of the features of the latter instrument.

- FEATURES:**
- Measures the direct capacitance of *ungrounded* capacitors.
  - Visual null indicator makes the bridge useful for production testing in noisy locations.
  - Simple to operate.
  - Normal operating conditions can be reproduced when testing polarized electrolytic capacitors by using a d-c polarizing voltage. The a-c voltage impressed by the bridge itself is small and simulates the ripple usually encountered in power-supply filters.

### SPECIFICATIONS

**Capacitance Range:**  $5\mu\mu\text{f}$  to  $1100\mu\text{f}$  in seven ranges. Capacitance values are read directly from a logarithmic dial and multiplier switch.

**Capacitance Accuracy:** Within  $\pm 1\%$  over the main decade (1 to 11) of the CAPACITANCE dial for all multiplier settings except .0001. Within  $\pm 1.5\%$  or  $\pm 3\mu\mu\text{f}$ , whichever is the larger, on the .0001 multiplier on the main decade of the CAPACITANCE dial. Below  $100\mu\mu\text{f}$  the error gradually increases to  $\pm 5\mu\mu\text{f}$  as zero is approached.

**Dissipation Factor Range:** 0 to 50% in two ranges. Scale has 50 divisions.

**Dissipation Factor Accuracy:** Within  $\pm 1.5\%$  of full-scale reading for all capacitance multipliers except .0001.

On the .0001 capacitance multiplier a correction of 0.3% should be subtracted from the dissipation-factor dial reading. When this correction is made the accuracy is within  $\pm 2$  divisions on the x1 multiplier and within  $\pm 1$  division on the x10 multiplier.

**Voltage Applied to Unknown:** The voltage impressed

across the unknown terminals varies continuously with the bridge setting. For very small capacitances in the lowest range, this voltage is approximately 35 volts, and it decreases with increasing capacitance, so that at  $100\mu\text{f}$  it is approximately one volt.

**Polarizing Voltage:** Terminals for connecting a d-c polarizing voltage are provided on the panel.

**Power Supply:** 105 to 125 (or 210 to 250) volts, 60 cycles. The power input is 15 watts.

**Controls:** Capacitance dial and multiplier, dissipation-factor control and multiplier, sensitivity control.

**Accessories Supplied:** TYPE CAP-35 Power Cord and spare fuses.

**Tube Complement:** One each 6X5GT/G, 6J7, 6E5.

**Mounting:** Portable carrying case, of airplane-luggage construction.

**Dimensions:** (Length)  $14\frac{1}{2}$  x (width) 15 x (height)  $9\frac{1}{4}$  inches, over-all, including cover and handles.

**Net Weight:** 19 pounds.

Type	Code Word	Price
740-B	BABEL	\$250.00



## TYPE 1611-A CAPACITANCE TEST BRIDGE

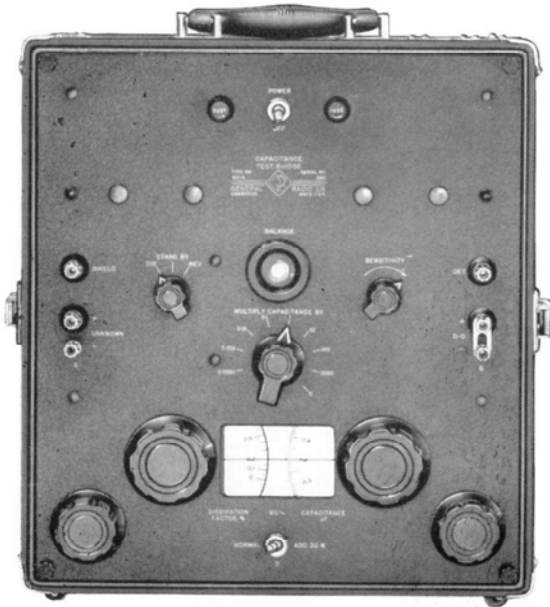

**USES:** The TYPE 1611-A Capacitance Test Bridge is designed for 60-cycle capacitance and dissipation-factor measurements over very wide ranges. It is suitable for laboratory or shop testing of all kinds of paper and mica capacitors, as well as polarized electrolytic capacitors. It also meets the requirements of the electric-power industry for shop testing of insulators, particularly for measurement of dissipation factor of bushings, insulators, the insulation of transformers, rotating machinery and cables. It can be used in such measurements even where there are adjacent bus potentials of several thousand volts.

For the wire and cable manufacturer, this bridge offers a convenient and rapid means for locating breaks in cable, and for laboratory and production tests of dissipation factor

and capacitance on all kinds of cable.

The communications industry will find it useful, not only for routine capacitance and dissipation-factor tests on component capacitors, but also for checking capacitance to ground of transformer windings, shields, and circuit elements.

**DESCRIPTION:** The circuit used is the series-resistance capacitance bridge. One ratio arm is continuously variable and calibrated to read directly in capacitance. The other ratio arm is variable in decade steps and serves as a multiplier for the direct-reading dial. The variable resistors in series with the standard capacitors are calibrated directly in dissipation factor.

A visual null indicator is used, consisting of a tuned amplifier and an electron-ray tube.

A portable luggage-type carrying case houses the complete instrument.

**FEATURES:** ➤ Will measure any capacitor up to 11,000 microfarads. There is no fixed lower limit. The range extends down to zero.

➤ Visual null indicator is an advantage in noisy locations.

➤ Detector sensitivity increases as balance point is approached, which greatly simplifies process of locating balance.

➤ Use of low test voltage results in considerable saving in cost over equipment operating at several kilovolts. Tests have proved that capacitance and dissipation factor do not depend upon voltage if no corona occurs.

➤ Moderate external electrostatic fields do not affect results, since connection to generator can be reversed and the observed results averaged.

➤ A d-c polarizing voltage can be introduced from an external d-c source.

➤ Requires no accessories — ready for operation when connected to power line.

### SPECIFICATIONS

**Capacitance Range:** 0 to 11,000  $\mu\text{f}$ , covered by eight multiplier steps and an approximately logarithmic, direct-reading dial.

**Dissipation-Factor Range:** 0 to 60% (at 60 cycles). A dial having a scale characteristic approximately logarithmic covers the range 0 to 30%. An additional range of 30% can be added by a panel switch.

**Capacitance Accuracy:**  $\pm(1\% + 1\mu\text{f})$  over the entire range of the bridge.

**Dissipation-Factor Accuracy:**  $\pm(2\%$  of dial reading

$+ 0.05\%$  dissipation factor). Power Factor =  $\frac{D}{\sqrt{1 + D^2}}$ ,

where  $D$  = dissipation factor. Below 100  $\mu\text{f}$ , the accuracy is limited by the decreasing sensitivity of balance.

**Sensitivity:** The sensitivity is such that any capacitance

in the range 100  $\mu\text{f}$  to 10,000  $\mu\text{f}$  can be balanced to a precision of at least 0.1%.

**Temperature and Humidity Effects:** The readings of the bridge are unaffected by temperature and humidity variations over the range of room conditions normally encountered (65° F to 95° F, 0 to 90% RH).

**A-C Voltage Applied to Capacitance under Test:** The voltage impressed on the unknown capacitance varies from a maximum of approximately 125 volts at 100  $\mu\text{f}$  to less than 3 volts at 10,000  $\mu\text{f}$ . The circuit is so arranged that a maximum of one volt-ampere of reactive power is delivered to the sample.

**External Fields:** For bushing testing, the fields usually encountered in shop and laboratory, even up to several thousand volts, will not affect the accuracy. For measurements in locations where the overhead voltages are



very high, the unknown should be shielded.

**Polarizing Voltage:** Terminals are provided for connecting an external d-c polarizing voltage. The maximum voltage that should be impressed is 500 volts.

One of the terminals is grounded so that any a-c operated power supply with grounded output can be used. The terminal capacitances of the power supply do not affect the bridge circuit.

**Power Supply Voltage:** 105 to 125 (or 210 to 250) volts, 60 cycles. **Power Input:** 15 watts.

**Accessories Supplied:** TYPE CAP-35 Power Cord and spare fuses.

**Mounting:** Portable carrying case of luggage-type construction. Case is completely shielded to insure freedom from electrostatic pickup.

**Tube Complement:** One each 6X5-GT/G, 6SJ7, and 6U5.

**Net Weight:** 30½ pounds.

**Dimensions:** (Width) 14½ x (depth) 16 x (height) 10 inches, over-all, including cover and handles.

Type		Code Word	Price
1611-A	Capacitance Test Bridge (115 and 230v, 60c)	FORUM	\$525.00
1611-AS1	Capacitance Test Bridge (115 and 230v, 50c)	FORUMPASHA	550.00

### TYPE 1611-AS2 CAPACITANCE TEST BRIDGE

**USES:** Current RETMA standards call for the measurement of electrolytic capacitors at 120 cycles. The TYPE 1611-AS2 Bridge, which is a modification of the TYPE 1611-A Bridge described above, is especially designed for the measurement of electrolytic capacitors from 1 µf to 11,000 µf at 120 cycles and to 0.1 µf with somewhat less than rated accuracy. A d-c polarizing voltage can be applied.

**DESCRIPTION:** Similar to the TYPE 1611-A Bridge for 60 cycles except that provision is also made for the use of an external 120-cycle supply with the upper four multiplier ranges, and the detector filter is tuned either to 60 or 120 cycles as selected. Polarizing voltage must be supplied from an external source.

#### SPECIFICATIONS

**Capacitance Range:** 0 to 11,000 µf at 60 cycles, 1 µf to 11,000 µf at 120 cycles or other external frequency. **Dissipation-Factor Range:** 0 to 60% at 60 cycles. Range proportional to frequency. (0 to 120% at 120 cycles.)

Dial readings must be multiplied by the ratio  $\frac{f}{60}$  for frequencies other than 60 cycles.

**Accuracy:** Capacitance  $\pm 1\%$ . Dissipation factor  $\pm (2\%$

of dial reading  $+0.05\% \times \frac{f}{60}$  dissipation factor).

**Detector Filter:** Tuned to 60 or 120 cycles, selected by switch. Jack provided for use of an external filter for other frequencies.

**External Generator:** Required for frequencies other than 60 cycles. TYPE 1214-AS2 Oscillator described below is recommended for 120-cycle measurements.

Other specifications are identical to those for TYPE 1611-A Bridge described above.

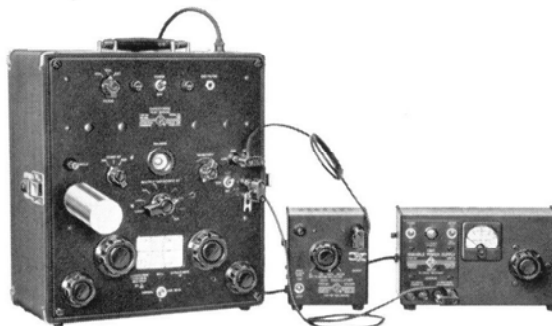

TYPE 1611-AS2 Capacitance Test Bridge used with the TYPE 1214-AS2 Oscillator to measure an electrolytic capacitor. The TYPE 1204-B Unit Variable Power Supply on the right supplies the d-c polarizing voltage.

Type		Code Word	Price
1611-AS2	Capacitance Test Bridge.....	FAVOR	\$545.00

### TYPE 1214-AS2 120-CYCLE OSCILLATOR

This oscillator is intended to drive the TYPE 1611-AS2 Capacitance Bridge at 120 cycles. It is very similar to the TYPE 1214-A Unit Oscillator (page 112) except for frequency and output circuit. The output control is a four-position switch to provide four different output impedances, to match the TYPE 1611-AS2 Bridge at each of its four 120-cycle multiplier settings, and is marked in terms of bridge multipliers.

A jack is provided for plugging in an external oscillator so that the output transformer and switching can be used at frequencies other than 120 cycles.

#### SPECIFICATIONS

**Frequency:** 120 cycles  $\pm 2\%$ .

**Output:** At least 200 milliwatts into matched load.

**Controls:** Output impedance switch and power switch.

Other specifications are identical to those for TYPE 1214-A Unit Oscillator (see page 112).

Type		Code Word	Price
1214-AS2	120-cycle oscillator (including power supply).....	ABBOT	\$95.00

PATENT NOTICE. See Note 2, page viii.



## TYPE 650 IMPEDANCE BRIDGE

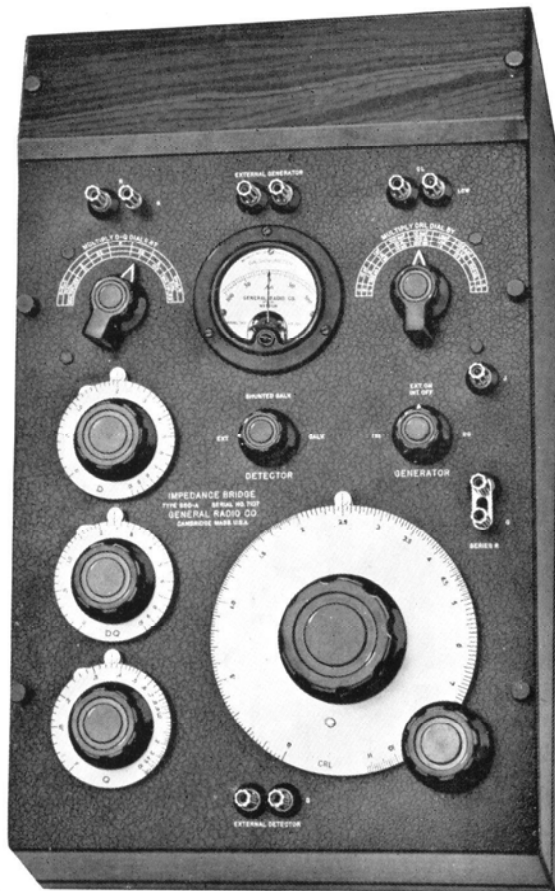

**USES:** The TYPE 650 Impedance Bridge will measure the inductance and storage factor,  $Q$ , of coils, the capacitance and dissipation factor,  $D$ , of capacitors, and the a-c and d-c resistance of all types of resistors.

In the laboratory it is extremely useful for measuring the circuit constants in experimental equipment, testing preliminary samples, and identifying unlabeled parts. In the shop and on the test bench it has many

applications in routine testing and fault location. Thousands of these bridges are in use all over the world, in government and industrial laboratories, educational institutions, electric generating stations, and radio broadcasting stations.

**DESCRIPTION:** The Bridge is a conventional 4-arm impedance bridge. It is entirely self-contained, including standards and tone source, and is direct reading over wide ranges of resistance, capacitance and dissipation factor, and inductance and storage factor.

Results are read directly from dials having logarithmic scales. The position of the decimal point and the electrical unit in terms of which the measurement is made are indicated by the positions of two selector switches.

Resistance is measured in terms of a standard resistance arm; inductance and capacitance are measured in terms of mica capacitance standards, similar in construction to the TYPE 505 Capacitors

A built-in galvanometer is used as the detector for d-c work, and head telephones, usually preceded by an amplifier, are used for a-c measurements.

Two Models are available. TYPE 650-AP is a-c operated, has a vacuum-tube 1-kc oscillator and an amplifier which can be operated with a flat characteristic or be peaked at 1 kc. TYPE 650-A operates from self-contained batteries and microphone hummer for 1 kc signal. The TYPE 650-P1 Oscillator-Amplifier is available separately and converts TYPE 650-A into TYPE 650-AP.

**FEATURES:** ➤ Wide ranges of all kinds of impedances can be measured simply and rapidly. ➤ Convenience, combined with sufficient accuracy for all but very precise work, makes the TYPE 650-A invaluable in any laboratory concerned with electrical measurements.

➤ Direct-reading dials eliminate additional time and trouble with calculations. The panel photograph shows the simplicity of the controls.

### SPECIFICATIONS

Ranges:	Minimum	Maximum
Resistance	1 milliohm	1 megohm
Capacitance	1 micromicrofarad	100 microfarads
Inductance	1 microhenry	100 henrys
Dissipation Factor $\left(\frac{R}{X}\right)$	.002	1
Storage Factor $\left(\frac{X}{R} \text{ or } Q\right)$	.02	1000

**Accuracy:** Accuracy of readings for capacitance and d-c resistance is 1% for the intermediate multiplier decades; for inductance, 2%. The accuracy falls off in the lower ranges because of the extremely small values to be measured. The error increases to 2% for very large values of capacitance and d-c resistance, and to 10% for large values of inductance.

Accuracy of reading for dissipation factor or for storage factor in terms of its reciprocal is either 20% or 0.005, whichever is the larger. For dissipation factors larger than 0.05 and for corresponding storage factors, the accuracy is 10%. For capacitances of less than 500





$\mu\mu\text{f}$  and for inductances greater than 10 henrys, the error increases, reaching 20%  $\pm 0.01$  at the extremes of range (100  $\mu\mu\text{f}$  or 100 henrys).

The frequency of the microphone hummer is 1000 cycles within  $\pm 5\%$  in TYPE 650-A. The vacuum-tube oscillator frequency in the TYPE 650-AP is within  $\pm 1\%$ .

**Power Supply:** Four No. 6 dry cells with connectors are supplied with TYPE 650-A Bridge inside cabinet. For TYPE 650-AP Bridge, 105 to 125 (or 210 to 250) volts, 50 to 60 cycles, 10 watts.

**External Generator:** For measurements at frequencies other than 1 kc and up to 10 kc, an external generator

can be used. An external TYPE 578 Shielded Transformer is recommended.

**Accessories Required:** High-impedance earphones; Brush model 200 are recommended.

**Tube Complement:** TYPE 650-AP, 1 — 6H6, 2 — 6SL7GT; TYPE 650-A, none.

**Mounting:** Black-crackle-finish aluminum panel; shielded walnut cabinet.

**Dimensions:** (width) 12 x (depth) 20 x (height) 8½ inches, over-all.

**Net Weight:** TYPE 650-AP, 30 pounds; TYPE 650-A 31½ pounds including batteries.

**SPECIFICATIONS FOR TYPE 650-P1 OSCILLATOR-AMPLIFIER**



**Oscillator:**

- Frequency: 1 kc  $\pm 1\%$ .
- Harmonics: less than 4% at full output.
- Open-circuit Voltage: continuously adjustable up to maximum of 10 to 15 volts.
- Internal Impedance: 2000 ohms.
- Hum Level: 15 mv.

**Amplifier:**

- Voltage Gain: continuously adjustable up to about 45 db (with average headphones).
- Selectivity: approximately 15 db attenuation to second harmonic when tuned to 1 kc.
- Hum Level: inaudible.

**D-C Output:**

- Open-circuit Voltage: 180 volts, approximately.
- Internal Resistance: 23,000 ohms.

Maximum Current: 8 ma, no adjustment provided. Can be short-circuited without damage.

Hum Level: less than 100 mv, no load.

**Power Supply:** 105 to 125 (or 210 to 250) volts, 50 to 60 cycles.

**Power Input:** 10 watts.

**Tube Complement:** 1 — 6H6 2 — 6SL7-GT

**Accessories Supplied:** Connector for use between oscillator-amplifier and bridge, and CAP-35 Power Cord.

**Accessories Recommended:** Headphones or a-c output meter for use with amplifier on a-c measurements.

**Dimensions:** Cabinet: 10½ x 2½ x 6¾ inches.

Panel: 12 x 3¾ inches.

**Net Weight:** 9 pounds.

Type	Description	Code Word	Price
650-AP	Impedance Bridge, A-C operated.....	FILLY	\$425.00
650-A	Impedance Bridge, Battery operated.....	BEAST	270.00*
	Model 200 Earphones.....	TELLO	12.00
650-P1	Oscillator-Amplifier only, for converting Type 650-A into Type 650-AP.....	BOGUS	155.00

\* Without earphones, but including batteries.

PATENT NOTICE. For TYPE 650-AP and TYPE 650-P1, see Notes 9 and 14, page viii.

Schematic diagrams of the circuits used in the TYPE 650-A Impedance Bridge.

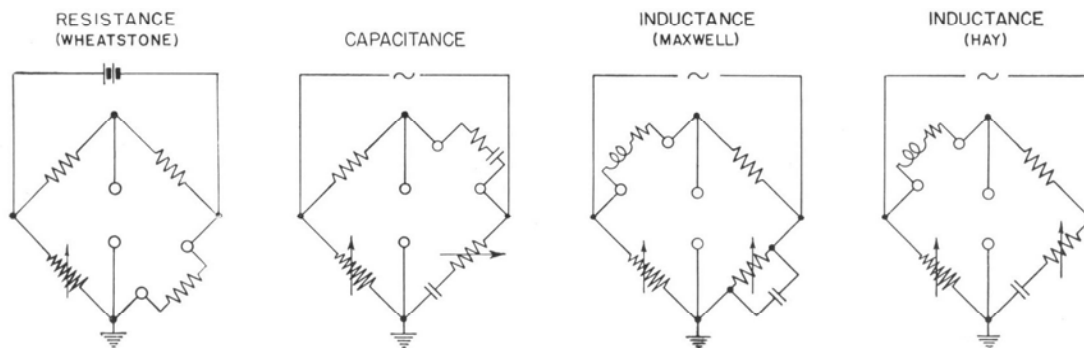



## TYPE 667-A INDUCTANCE BRIDGE

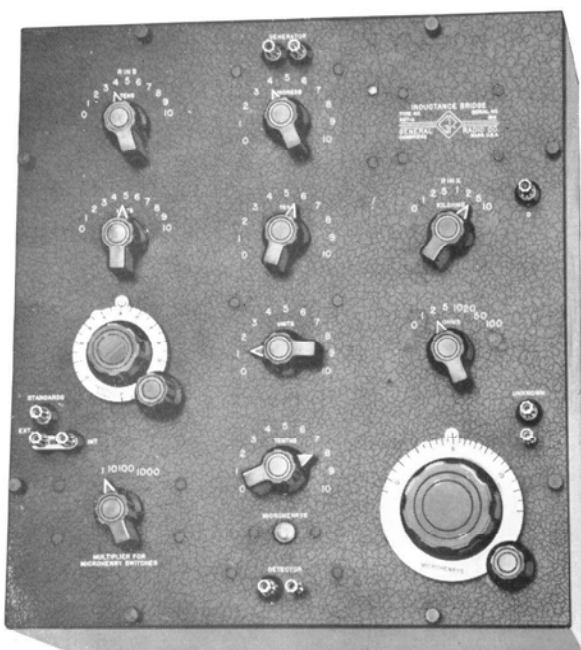

**USES:** This bridge is designed for accurately measuring the audio-frequency inductance of small coils, which have a low value of storage factor,  $Q$ , at audio-frequencies. It is used by many coil and receiver manufacturers for all audio-frequency measurements on the tuning coils for radio receivers. It is also capable of measuring higher values of inductance (up to 1 henry) and hence can be used as a general-purpose inductance bridge. When connected as a Campbell mutual-inductance bridge, it can be used to measure mutual inductance in

terms of the internal standard. Terminals are provided so that the bridge can be connected as a resonance bridge for such measurements as the ratio of a-c to d-c resistance. The d-c resistance can be determined by using a battery and galvanometer in place of the usual a-c generator and detector.

**DESCRIPTION:** The TYPE 667-A Inductance Bridge is a conventional impedance bridge specifically designed for inductance measurements. The necessary design features to eliminate residual sources of error and to make the bridge direct reading have been incorporated. The variable resistors in both the standard and the unknown arms are inductance compensated, identical in construction with TYPE 670 Compensated Decade Resistor.

A variable inductor in series with the unknown makes it possible to obtain a final inductance balance independent of the resistive balance of the bridge. The standard inductor is wound on a ceramic toroidal form in order to minimize magnetic coupling with the variable inductor.

**FEATURES:** ➤ High accuracy (within  $0.1 \mu\text{h}$ ) for the measurement of small inductances is one of the outstanding features of this bridge.  
 ➤ Errors introduced by a sliding-zero balance and the variation of inductance with setting of the decade resistors have been eliminated. Thus inductors of a few microhenrys can be measured accurately.  
 ➤ An internal standard is provided for convenience, but terminals are available for external standards when necessary to extend the range of the bridge.

### SPECIFICATIONS

**Range:** Inductance, 0.1 microhenry to 1 henry. The range can be extended by using TYPE 1482 Standard Inductors as external standards. When the internal standard is used, the bridge will balance for storage factors between 0.05 and infinity at 1 kc.

**Accuracy:** Inductance,  $\pm(0.2\% + 0.1 \mu\text{h})$ . The capacitance across the UNKNOWN terminals is about  $60 \mu\text{mf}$ . Specific value is given for each bridge. This capacitance will increase the measured value of large inductors fractionally by the amount  $\omega^2 LC$ . At 1 kc and 1 h the increase is about 0.24%. By direct substitution, two nearly equal external inductors can be compared to  $\pm 0.02\%$ .

**Frequency Range:** All calibration adjustments are made at a frequency of 1 kc. The bridge can be used at any frequency between 60 cycles and 10 kilocycles, but errors resulting from stray capacitance increase with frequency. When large values of inductance are measured

with external standards, the frequency should be lowered to avoid resonance effects.

**Standards:** The standard inductor is a 1-millihenry toroid wound on a ceramic form. Resistance balance of the bridge is made by means of resistors having small residual inductances.

**Mounting:** The bridge is supplied in a shielded walnut cabinet.

**Accessories Required:** Oscillator, amplifier, and ear-phones. TYPE 1214-A Oscillator (page 112) and TYPE 1231-B Amplifier and Null Detector (page 64), or the TYPE 1212-A Unit Null Detector (page 66) are recommended with the TYPE 1951-A Filter.

**Accessories Supplied:** Two TYPE 274-NCO Shielded Connectors.

**Dimensions:** (Length)  $17\frac{1}{2}$  x (width) 16 x (height)  $9\frac{1}{2}$  inches, over-all.

**Net Weight:** 33 pounds.

Type	Code Word	Price
667-A   Inductance Bridge.....	AERIE	\$470.00



## TYPE 1604-B COMPARISON BRIDGE

**USES:** The TYPE 1604-B Comparison Bridge is designed for the rapid testing of components at audio frequencies, by comparison with an appropriate standard. Typical measurements for which this versatile instrument is particularly suited include: production testing of ganged potentiometers or capacitors for tracking; measurement of small values of capacitance; checking center-tapped windings for proper location of tap, the rapid matching of components for use in critical circuits.

**DESCRIPTION:** This instrument is completely self-contained, consisting of a bridge circuit, an oscillator operating at 400 c, 1000 c, or 5 kc, and a sensitive cathode-ray-tube visual detector.

The bridge circuit consists of a pair of resistive ratio arms, with a potentiometer providing a calibrated variation from unity. A differential capacitor across the ratio arms provides the phase-angle balance. Measurements can be made with the unknown either grounded or not, as desired.

The detector is non-linear, and permits the bridge to be balanced without continual re-setting of the gain control.

**FEATURES:** ➤ Rapid measurements.



- Three measuring frequencies.
- High accuracy.
- Wide impedance range.
- Requires no accessories other than appropriate standard of reference — ready for operation when connected to power line.
- Visual null indicator.

### SPECIFICATIONS

**Deviation Range:** For impedance difference,  $\pm 5\%$  and  $\pm 20\%$ , selected by a panel switch. For dissipation factor difference,  $\pm .006$  at 400 c,  $\pm .015$  at 1 kc,  $\pm .075$  at 5 kc.

**Impedance Range and Accuracy:** Over the following ranges the accuracy is  $\pm 0.1\%$  for the  $5\%$  deviation range, and  $\pm 0.5\%$  for the  $20\%$  range, when dissipation-factor differences do not exceed 0.02.

Frequency	R	L	C
400 c	2 $\Omega$ to 20 M $\Omega$	2 mh to 1500 h	100 $\mu$ f to 50 $\mu$ mf
1 kc	2 $\Omega$ to 20 M $\Omega$	1 mh to 250 h	30 $\mu$ f to 50 $\mu$ mf
5 kc	4 $\Omega$ to 2 M $\Omega$	200 $\mu$ h to 10 h	2 $\mu$ f to 50 $\mu$ mf

**Dissipation Factor Accuracy:**

Frequency	Accuracy
400 c	$\pm (0.0002 + 2\%$ of the impedance difference)
1 kc	$\pm (0.0005 + 2\%$ of the impedance difference)
5 kc	$\pm (0.0025 + 2\%$ of the impedance difference)

**Frequency:** 400 c, 1 kc, and 5 kc, as selected by panel switch. All  $\pm 3\%$ .

**Grounding:** Two ground positions are provided: one grounds the junction of the standard and unknown impedances, so that the total impedances between the high terminals and ground are compared. In the other connection the junction of the ratio arms of the bridge is grounded, and the direct impedance between terminals of a component is measured; terminal im-

pedances to ground, within certain limits, will not affect the bridge balance.

**Voltage Applied to Unknown:** Approximately one volt, for impedances above 500 $\Omega$ . For lower values of impedance the voltage is decreased, corresponding to a source impedance of the order of 100 $\Omega$ .

**Zero Adjustment:** An adjustable index mark is provided with locking means so that the zero can be offset.

**Tube Complement:** Two 6AU6, three 12AT7, one 2PB1, one 117-Z6-GT.

**Power Supply:** 105-125 (or 210-250) volts, 50 to 60 cycles.

**Accessories Supplied:** TYPE CAP-35 Power Cord; spare fuses.

**Accessories Required:** Adjustable calibrated standards such as the TYPE 1432 Decade Resistors, TYPE 219 Decade Capacitors, and TYPE 1490 Decade Inductors may be used. Fixed standards such as the TYPE 509 Standard Capacitors, TYPE 1481 and TYPE 1482 Inductors, and TYPE 500 Resistors may also be used whenever appropriate values are available.

For production tests, the standard is often a component of the type to be tested, that has been measured independently or otherwise selected.

**Accessories Available:** TYPES 1231-P2 and 1231-P5 Filters (pages 108 and 109) for frequency discrimination.

**Mounting:** Welded aluminum cabinet.

**Dimensions:** (Width) 12 inches, (height) 14 $\frac{1}{4}$  inches, (depth) 10 inches, over-all.

**Net Weight:** 22 $\frac{1}{2}$  pounds.

Type	Code Word	Price
1604-B   Comparison Bridge.....	FATTY	\$440.00

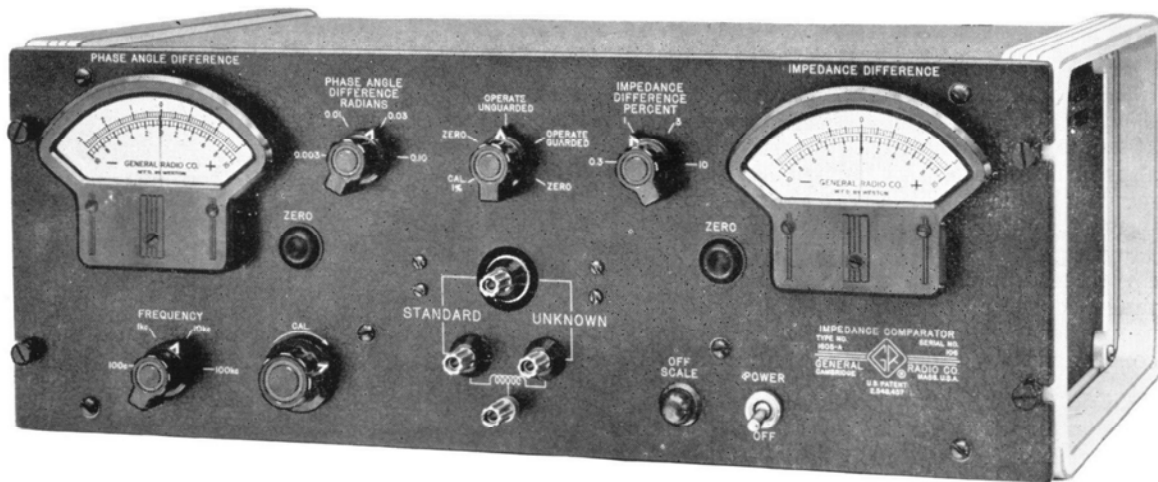

## TYPE 1605-A IMPEDANCE COMPARATOR

ACCURATE AND VERSATILE ON THE PRODUCTION LINE AND IN THE LABORATORY

**USES:** Typical uses include rapid testing, sorting, and matching of precision components, either manually or in combination with automatic sorting equipment.

Checking effects of time, temperature, humidity, and pressure on components, with high precision and continuous indication.

Rapid checking of tracking of ganged potentiometers and variable capacitors.

Frequency characteristics of components.

Easy comparison of quantities usually requiring laboratory techniques, such as:

Impedance difference to 0.01%.

D of low-loss dielectric materials.

D of Inductors.

Q or phase angle of wire-wound resistors or potentiometers.

Balance of transformer windings.

**DESCRIPTION:** This completely self-contained impedance comparator indicates directly on two panel meters the difference in impedance and phase angle between a pair of elements connected to its terminals. Three highly desirable characteristics not usually obtained together are combined in this unique instrument:

—high accuracy

—high speed

—wide ranges of impedance and frequency

As a result, not only does it bring laboratory accuracy to production-line inspection, but, conversely, it brings the speed of the production test to measurements in the laboratory.

The basic circuit of the comparator is a bridge circuit, with the unknown and standard

impedances serving as two of the bridge arms and the halves of a center-tapped transformer secondary winding serving as the other two arms. An internal R-C oscillator driving the transformer primary winding provides frequencies at 100 c, 1 kc, 10 kc, and 100 kc. The bridge unbalance voltage, resulting from inequality of standard and unknown impedances, is separated into in-phase and out-of-phase components that are amplified and indicated directly by two meters reading, respectively, impedance magnitude difference in per cent and phase-angle difference in radians.

The transformer is especially designed to have as high a degree of coupling as possible between the two halves of its secondary winding. The coefficient of coupling achieved is greater than 0.9997, and the open-circuit voltages of the two halves are balanced to within 1 part in  $10^6$ . This makes possible measurement of differences as low as 0.01% and minimizes the loading effect of external impedances on the bridge transformer.

A special cathode-follower-type circuit provides a very high input impedance for the bridge detector and also a guard terminal. This shield makes possible the measurement of high impedances at a distance from the instrument, as in an environmental test chamber.

For operating external selector circuits, meter voltages are available at the rear of the instrument; a plug connector is supplied.

Calibration can quickly be checked at any time by means of a simple built-in network.

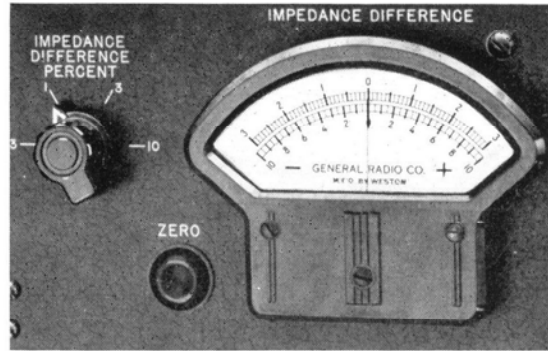
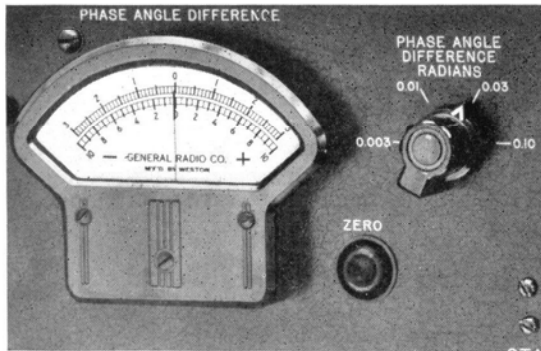

Close-up views of the meter scales and range switches.

- FEATURES:**
- High-speed meter indication: No balancing operation required.
  - Wide frequency range: 100 cycles to 100 kc.
  - High accuracy: measurements to 0.01%
  - Versatile: compares impedances of any phase angle.

- Wide impedance range: 2 ohms to 20 megohms
- Compares both magnitude and phase angle simultaneously
- Guard point available
- Completely self contained

**SPECIFICATIONS**

**Impedance Ranges:**

Resistance or impedance magnitude: 2 Ω to 20 MΩ  
 Capacitance: 40 μf to 500 μf; to 0.1 μf with reduced sensitivity.

Inductance: 10 μh to 10,000 h.

**Internal Oscillator Frequencies:** 100 c, 1 ke, 10 ke, 100 ke; all ± 3%.

**Meter Ranges:**

Impedance Magnitude Difference: ± 0.3%, ± 1%, ± 3%, ± 10% full scale.

Phase Angle Difference: ± 0.003, ± 0.01, ± 0.03, ± 0.1 radian full scale.

**Accuracy of Difference Readings:** 3% of full scale; i.e., for the ±0.3% impedance-difference scale, accuracy is 0.009% of the impedance magnitude being measured.

**Voltage Across Standard and Unknown:** approx. 0.15 volts

**Accessories Supplied:** TYPE CAP-35 Power Cord, tele-

phone plug, external-meter plug, adaptor plate assembly (fits panel terminals) and spare fuses.

**Tube Complement:**

1-5651	5-12AT7
1-5751	3-6U8
3-12AX7	1-6AS7G
4-6AL5	1-3A10
	1-VE65A1

**Power Supply:** 105 to 125 (or 210 to 250) volts, 50 to 60 cycles; 100 watts input at 115v line.

**Mounting:** Relay-rack panel with cabinet; TYPE 1605-AR has fittings to permit either instrument or cabinet to be removed from rack without disturbing the other; TYPE 1605-AM has end supports for table or bench use.

**Dimensions:** Panel 19 x 8¾ inches; depth behind panel, 12 inches.

**Net Weight:** 29½ pounds.

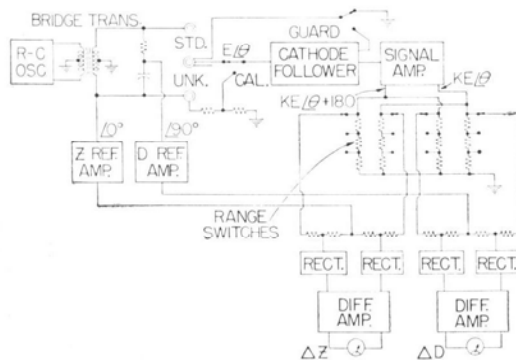

Block schematic of the TYPE 1605-A Impedance Comparator.

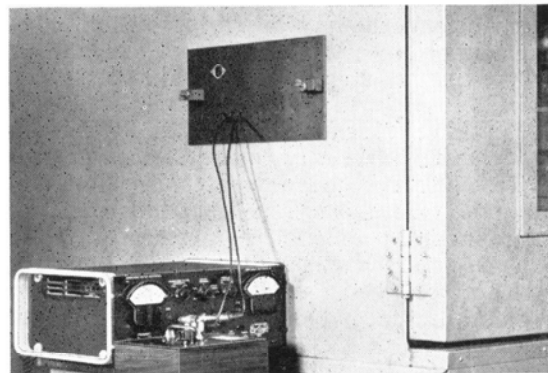

The built-in guard circuit permits the use of long leads from Comparator to sample inside conditioning chamber, as shown above.

Type	Code Word	Price
1605-AR	GUNNY	\$790.00
1605-AM	GIPSY	790.00

PATENT NOTICE. See Note 4, page viii.



## TYPE 1603-A Z-Y BRIDGE

### A NEW APPROACH TO AUDIO-FREQUENCY IMPEDANCE MEASUREMENTS

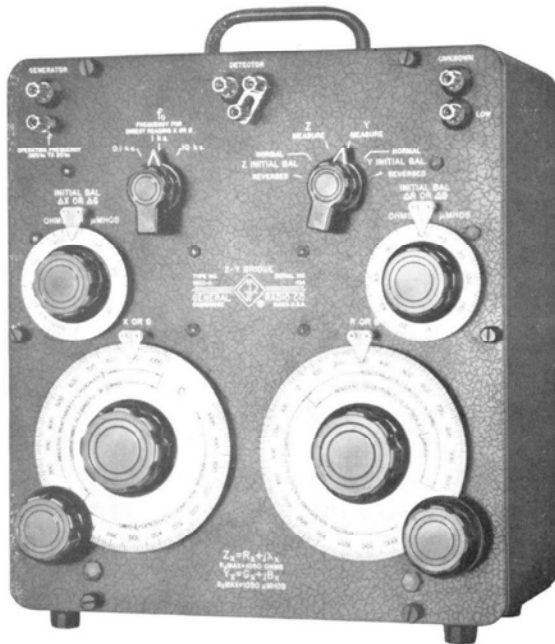

**USES:** This remarkable new bridge can easily be balanced for *any* impedance connected to its terminals—from short circuit to open circuit, real or imaginary, positive or negative. Thus it can make not only the usual routine measurements but can also solve many difficult problems beyond the capabilities of other measuring instruments. Clearly, such versatility belongs in any laboratory where electrical impedance measurements are made. A few of this instrument's manifold applications are:

Checking or identifying R, L, and C components, or any arbitrary combinations of them.

Reactance-resistance curves for electro-acoustic transducers, such as loudspeakers, microphones, magnetic recorder heads.

Open- and short-circuit measurements on transformers to determine leakage reactance, self and mutual inductance, and coefficient of coupling.

Frequency characteristics of electrolytic capacitors.

Measuring resonances of inductors and transformers.

Complex input, output, and characteristic impedances of filters and other transmission networks.

Transistor input and output impedance.

Conductivity of liquids.

In electro-chemical research, circular arc plots of solids or liquids having lossy polarizations.

Negative resistance of active circuits, such as feedback loops.

**DESCRIPTION:** The TYPE 1603-A Z-Y Bridge measures directly the quadrature components of a complex impedance  $Z = R + jX$ , or a complex admittance  $Y = G + jB$ . Low impedances are measured in terms of series  $R$  and  $X$ , while high impedances, i.e., low admittances, are measured in terms of parallel  $G$  and  $B$ . With overlapping  $R$  and  $X$  ranges from 0 to  $\pm 1050$  ohms and  $G$  and  $B$  ranges from 0 to  $\pm 1050$  micromhos, any value of unknown can be balanced as either an impedance or an admittance.\*

The basic circuit is the familiar resistance-capacitance bridge, but it is used in an entirely new manner. A substitution technique is employed whereby an initial balance, without the unknown element, is followed by a final balance with the unknown in the circuit. The difference in setting of the controls between these two balances measures the complex components of the unknown.

In the simplified circuit shown, the series rheostats provide the  $R$  balance for impedance and the  $B$  balance for admittance, while the parallel rheostats provide the  $G$  balance for admittance and the  $X$  balance for impedance.  $R$  and  $G$  readings are independent of frequency, while  $X$  and  $B$  readings are direct at any of three reference frequencies—100 c, 1 kc, and 10 kc as selected by a switch that changes certain bridge components. At frequencies other than these three,  $X$  and  $B$  readings must be, respectively, divided and multiplied by the ratio

$$\frac{(\text{operating frequency})}{(\text{reference frequency})} = \frac{f}{f_0}$$

The details of the controls and switching have been worked out to provide the utmost in convenience of operation. The unknown element is always connected to a single pair of terminals, and a main selector switch connects it internally for either impedance or admittance measurement and disconnects it during the initial balance. The final balance controls need not be set to zero for initial bal-

\*For a more detailed description consult *General Radio Experimenter* for July, 1955.



ance, because the main selector switch inserts fixed resistors in their place equal to the value they would have when set to read zero. This is a convenient feature in making frequency runs on the unknown.

The reference-frequency switch may be used as a multiplier for the *X* and *B* ranges by setting it to a value other than nearest the actual operating frequency. For measurement of very low impedances or admittances, the functions of the wide-range final balance controls and the narrow-range initial balance controls may be interchanged, and, to allow this use, the initial balance controls have accurately calibrated dials with about 15% the range of the main dials and with the lower range of their scales expanded.

By selecting the appropriate method of connecting the external detector to the bridge detector terminals provided, one can measure (1) the grounded, (2) the direct, or (3) the total delta value, balanced or unbalanced, of the unknown element—a valuable ability not possessed by most other instruments.

- FEATURES:**
- Will always give an answer no matter what the unknown is.
  - Switching and controls provide fast, convenient operation.

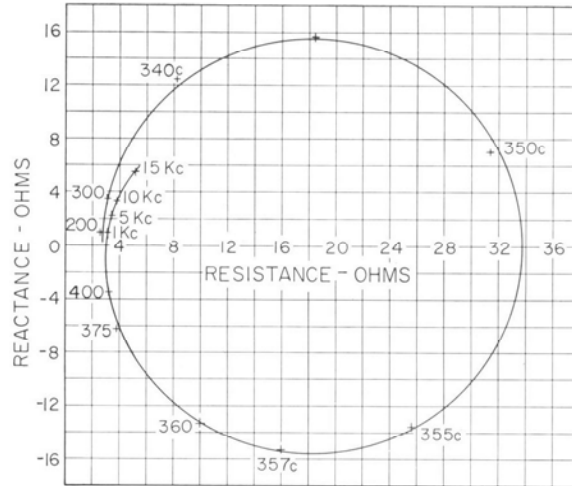

Reactance vs resistance for a typical loud speaker; data taken with TYPE 1603-A Z-Y Bridge.

- 1% accuracy.
- Covers entire audio frequency range.
- Gives answers directly in ohms or micromhos.
- Can measure grounded, direct, or balanced impedances or admittances.

**SPECIFICATIONS**

**Frequency Range:** 20 cycles to 20 kc.  
**Impedance and Admittance Range:** If the absolute resistance is less than 1000 ohms and the absolute reactance is less than  $1000 \frac{f_o}{f}$  ohms, the unknown is measured as an impedance. If the absolute conductance is less than 1000 micromhos and the absolute susceptance is less than  $1000 \frac{f}{f_o}$  micromhos, the unknown is measured as an admittance. Under certain limited conditions, a choice of *Z* or *Y* measurements is possible.

**Accuracy:** For real components. *R* or *G*:  $\pm(1\% + [2 \text{ ohms or } 2 \text{ micromhos}])$  for the main dials; components of less than about 100 ohms (or 100 micromhos) can be measured on the auxiliary dials within  $\pm(1\% + [0.2 \text{ ohm or } 0.2 \text{ micromho}])$ . For imaginary component, *X* or *B*:  $\pm(1\% + [\frac{2f_o}{f} \text{ ohm or } \frac{2f}{f_o} \text{ micromho}])$  for the main dials;

$\pm(1\% + [0.2 \frac{f_o}{f} \text{ ohm or } 0.2 \frac{f}{f_o} \text{ micromho}])$  for the auxiliary dials. To obtain this accuracy in the measurement of small quadrature components at the higher frequencies, correction data, supplied in the operating instructions, must be applied. The absolute measurements of *X* and *B*, but not *R* and *G*, involves the frequency error of the exciting generator.

**Maximum Applied Voltage:** 130 volts rms on bridge, giving less than 32 volts on unknown.

**Accessories Required:** A calibrated oscillator or other suitable a-c generator, and a null detector. The TYPE

1210-B Unit Oscillator (page 114) and the TYPE 1212-A Unit Null Detector, (page 66) are recommended.

**Accessories Supplied:** 2 TYPE 274-NCO Shielded Cables, for connections to generator and detector.

**Mounting:** Aluminum cabinet and panel. Black crackle finish. Carrying handle provided.

**Dimensions:** Panel: (Width) 12½ x (height) 13½ x (depth) 8½ inches, over-all.

**Net Weight:** 21½ pounds.

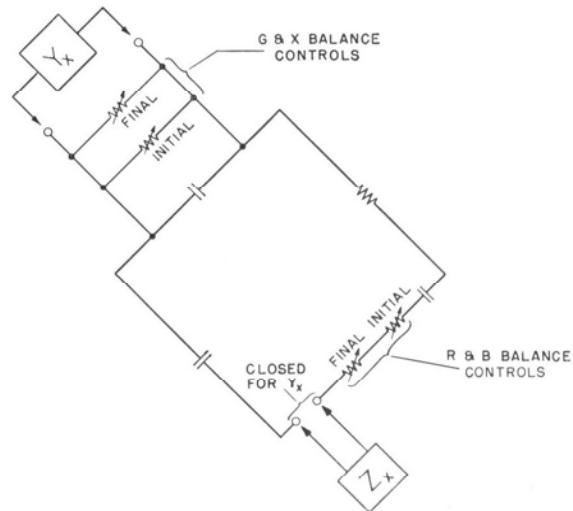

Type	Code Word	Price
1603-A   Z-Y Bridge.....	CATER	\$355.00

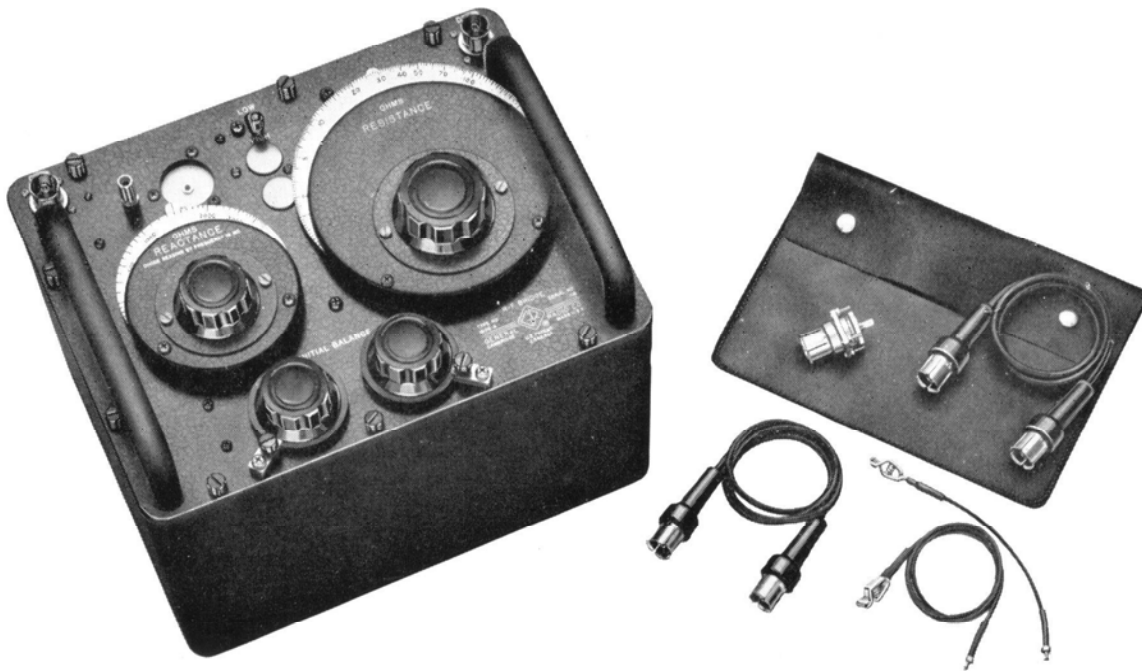

### TYPE 1606-A RADIO-FREQUENCY BRIDGE

**USES:** The TYPE 1606-A Radio-Frequency Bridge measures impedances simply and accurately at frequencies from 400 kc to 60 Mc. It measures directly the resistance and reactance of antennas, transmission lines, networks, and components. Although designed primarily for measuring the low values of impedance most often encountered in r-f devices, its range can be extended by means of an external parallel capacitor so as to measure high impedances, such as tuned circuits.

This bridge is a new and improved model superseding the very popular TYPE 916-A — for many years the standard of the radio industry for r-f impedance measurements.

**DESCRIPTION:** The bridge circuit used is shown schematically in the diagram below. Measurements are made by a series-substitution method. The components of the unknown impedance are determined from the change in settings of capacitors  $C_A$  and  $C_P$ . The unknown reactance at 1 Mc is read directly in ohms from the dial of  $C_P$ , and the unknown resistance in ohms from the dial of  $C_A$ .

In making measurements the bridge is first balanced by means of capacitors  $C_P$  and  $C_A$  with a short-circuit across the unknown terminals. The short is then removed, the unknown impedance connected, and the bridge rebalanced. The resistance is then given by

$$R_x = R_B \frac{(C_{A2} - C_{A1})}{C_N}$$

and the reactance by

$$X_x = \frac{1}{\omega} \left( \frac{1}{C_{P2}} - \frac{1}{C_{P1}} \right)$$

where the subscripts 1 and 2 denote the dial readings for the initial and final balances, respectively.

The resistive component is measured in terms of a *fixed* resistor ( $R_B$ ), a fixed capacitor ( $C_N$ ), and a variable capacitor ( $C_A$ ). This

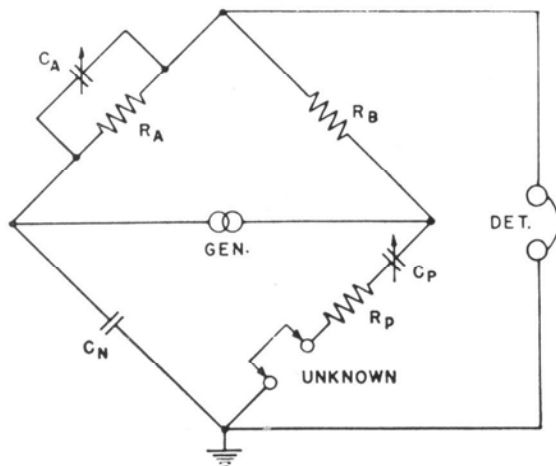





feature is an important factor in the high-frequency performance of the bridge because residual parameters can be made much smaller in a fixed resistor and a variable capacitor than in a variable resistor.

The TYPE 1606-A Bridge incorporates several important new advances in bridge design. A single, internal bridge transformer, used to couple an external generator to the bridge circuit, covers the entire 150:1 frequency range of the instrument while its triple shielding keeps undesired couplings to an insignificant level. A new type of variable air capacitor, having very low losses and inductance, is used for the reactance balances and the initial resistance balance. In this capacitor the complete rotor and stator sections are milled out of solid blocks of aluminum, a construction that avoids losses at the joints between plates and spacers and provides the utmost stability. Finally, the entire mechanical design is such that the instrument can operate under difficult environmental conditions similar to those specified for testing military electronics equipment, which makes the TYPE 1606-A Bridge an excellent instrument for portable field use.

- FEATURES:** ➤ High accuracy and reliability  
➤ Fast, simple operation

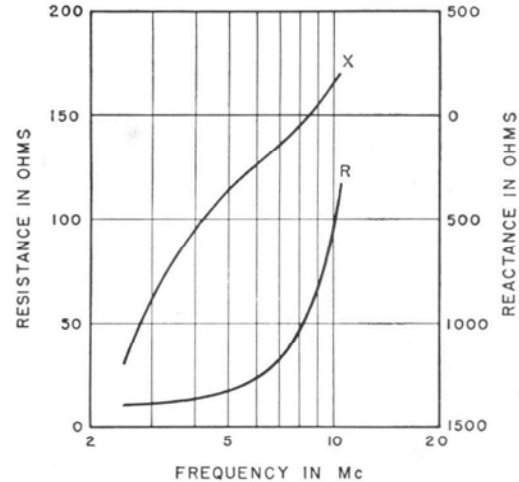

Reactance and resistance of an antenna system measured with the Radio-Frequency Bridge.

- Wide frequency range
- Measures most impedances directly
- Small, light, and rugged for field use — carrying case available
- Initial balance controls have clamps to prevent accidental movement.
- Represents the best, most progressive practice in bridge design.

**SPECIFICATIONS**

**Frequency Range:** 400 Kc to 60 Mc.  
**Reactance Range:**  $\pm 5000\Omega$  at 1 Mc. This range varies inversely as the frequency; and at other frequencies the dial reading must be divided by the frequency in megacycles.  
**Resistance Range:** 0 to 1000 $\Omega$ .  
**Accuracy:** For reactance at frequencies up to 50 Mc,  $\pm (2\% + 1\Omega + 0.0008 \times R \times f)$ , where  $R$  is the measured resistance in ohms and  $f$  is the frequency in Mc.  
 For resistance, at frequencies up to 50 Mc,

$$\pm \left[ 1\% + 0.0024f^2 \left( 1 + \frac{R}{1000} \right) \right] \% \pm \frac{10^{-4} X}{f} \Omega + 0.1\Omega$$

subject to correction for residual parameters.  $R$  is the measured resistance in ohms,  $X$  is the measured reactance in ohms, and  $f$  is the frequency in Mc. At high frequencies, the correction depends upon the frequency and magnitude of the unknown resistance component. A chart from which the correction can be determined is given in the instruction book supplied with the bridge.

Satisfactory operation can be obtained at frequencies as low as 100 Kc and somewhat above 60 Mc with not quite as good accuracy as indicated above. The  $f^2$  term is important only at frequencies above 10 Mc. The  $1/f$  term is important only at very low frequencies when the resistance of a high-reactance, low-loss capacitor is measured.

**Terminals:** Generator and detector terminals are TYPE

874 Coaxial Connectors. Adaptors to all commonly used coaxial connectors are available (see page 62).

**Accessories Supplied:** Two leads of different lengths for connecting the unknown impedance to the bridge terminals, one  $\frac{1}{2}$ " spacer and one  $\frac{3}{4}$ ", 6-32 screw for mounting components directly on the bridge terminals, two TYPE 874-R22 Coaxial Cables for connecting the generator and detector, and one TYPE 874-PB58 Panel Connector.

**Other Accessories Required:** Radio-frequency generator and detector. The TYPE 1330-A Bridge Oscillator and the TYPE 1211-B Unit Oscillator are satisfactory generators, as are the TYPE 1001-A and the TYPE 805-C Standard-Signal Generators. At frequencies above 50 Mc a TYPE 1215-B Unit Oscillator or a TYPE 1021-AV Standard-Signal Generator is recommended.

A well-shielded communications receiver covering the desired frequency range makes a satisfactory detector. It is recommended that the receiver be fitted with the TYPE 874-PB58 Panel Connector or other coaxial connector to avoid leakage at the input connection.

**Mounting:** Welded aluminum cabinet supplied. A luggage-type carrying case is available separately and is recommended if the bridge is to be used as a portable field instrument.

**Dimensions:**  $12\frac{1}{2} \times 9\frac{1}{2} \times 10\frac{1}{4}$  inches, over-all.  
**Net Weight:** 23 pounds without carrying case; 29 pounds with carrying case.

Type		Code Word	Price
1606-A	Radio Frequency Bridge*	CIGAR	\$590.00
1606-P1	Luggage-type Carrying Case	BILLY	17.50

\*PATENT NOTICE. See Notes 4 and 12, page viii.

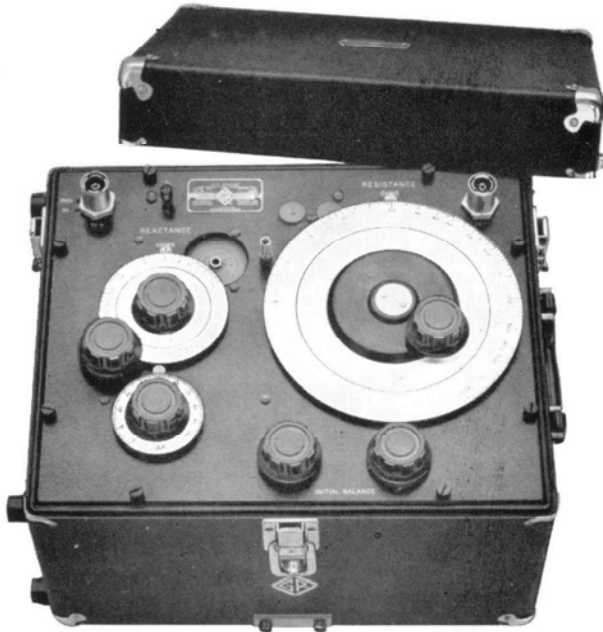

## TYPE 916-AL RADIO-FREQUENCY BRIDGE

**USES:** The TYPE 916-AL Bridge measures impedances quickly and accurately at frequencies from 50 kc to 5 Mc. It measures directly the resistance and reactance of antennas, transmission lines, networks, and components. Although designed primarily for measuring the low values of impedance most often encountered in its frequency range, its impedance range can be extended by means of an external parallel capacitor so as to measure high impedances, such as tuned circuits.

**DESCRIPTION:** The circuit is similar to that of the TYPE 1606-A R-F Bridge used at higher frequencies (see page 36). Two transformers are used to cover the entire frequency range, the lower limit of which can be extended down to 15 kc for many measurements.

**FEATURES:** ➤ High accuracy and reliability  
➤ Fast, simple operation  
➤ Measures most impedances directly  
➤ Suitable for field use

### SPECIFICATIONS

**Frequency Range:** 50 kc to 5 Mc. Satisfactory operation for many measurements can be obtained at frequencies as low as 15 kc.

**Reactance Range:**  $\pm 11,000\Omega$  at 100 kc. This range varies inversely as the frequency, and at other frequencies the dial readings must be divided by the frequency in hundreds of kilocycles. To facilitate the measurement of small reactances, the instrument is provided with an incremental reactance dial which has a range of 100 ohms at 100 kc.

**Resistance Range:** 0 to 1000 $\Omega$ .

**Accuracy:** For reactance at frequencies up to 3 Mc,  
 $\pm (2\% + 0.2 \times \frac{100}{f_{kc}} \Omega + 3.5f_{kc}^2 R \times 10^{-10}\Omega)$  where  $R$

is the measured resistance in ohms and  $f_{kc}$  is the frequency in kilocycles. The errors in reactance increase relatively rapidly at frequencies above 3 Mc; and at 5 Mc the accuracy is  $\pm (2\% + 0.01\Omega + 2.3 R^{1.4} + 10^{-3}\Omega)$ .

For resistance, at frequencies up to 5 Mc,  $\pm (1\% + 0.1\Omega)$ , subject to correction for residual parameters at low frequencies. The correction depends upon the frequency and upon the magnitude of the unknown

reactance component. A plot of this correction is given in the instruction book supplied with the bridge.

**Accessories Supplied:** Two input transformers, one covering the lower portion of the frequency range, the other the higher portion; two leads of different lengths (for connecting the unknown impedance); two 874-R22 Coaxial Cables for connecting generator and detector; one TYPE 874-PB58 Panel Connector.

**Other Accessories Required:** Radio-frequency generator and detector. The TYPE 1330-A Bridge Oscillator and the TYPE 1211-B Unit Oscillator are satisfactory generators as are the TYPE 1001-A and the TYPE 805-C Standard Signal Generators. A well-shielded radio receiver covering the desired frequency range makes a satisfactory detector. It is recommended that the receiver be fitted with the TYPE 874-PB58 Panel Connector supplied to avoid leakage at the input connection.

**Mounting:** Airplane-luggage type case with carrying handle. Both input transformers are stored inside the case. Coaxial cables, leads, and instruction book are stored in the cover of the instrument when not in use.

**Dimensions:** 17 x 13 $\frac{1}{2}$  x 11 $\frac{1}{8}$  inches, over-all.

**Net Weight:** 34 $\frac{1}{2}$  pounds.

Type	Code Word	Price
916-AL   Radio-Frequency Bridge (50 kc to 5 Mc)...	CLUCK	\$590.00

PATENT NOTICE. See Notes 4 and 12, page viii.



## TYPE 1601-A V-H-F BRIDGE

**USES:** The TYPE 1601-A V-H-F Bridge is designed for the direct measurement of relatively low impedances at frequencies between 10 and 165 megacycles. It will measure high impedances indirectly. Among its applications are measurements on antennas, lines, networks, and components. It is particularly well adapted for the accurate measurement of 50 ohm coaxial systems, and is supplied with a coaxial adaptor to fit the bridge unknown terminal. For measurements on components and other lumped impedances, a pair of terminals (one grounded) or a single terminal with ground plane are provided.

**DESCRIPTION:** The measurement is made by a series substitution method using the same basic bridge circuit as the TYPE 1606-A Radio-Frequency Bridge (see page 36). The resistive and reactive components of the unknown impedance are measured in terms of incremental capacitances, and the magnitude of each is indicated on a separate dial. Calibrations are in ohms resistance and in ohms reactance at 100 megacycles.

Particular attention has been paid to the design of the bridge transformer and of the terminal structure to which the unknown impedance is connected, in order that the bridge be direct-reading, with a minimum of corrections.

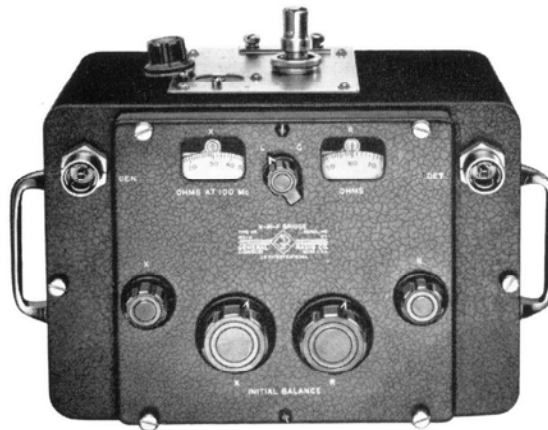

- FEATURES:**
- This bridge is as convenient to use as those operating at much lower frequencies.
  - Terminal arrangement permits both coaxial and lumped circuits to be measured.
  - Bridge is small enough and light enough to permit its use in locations such as antenna towers which would be inaccessible to heavier equipment.
  - Accuracy is better than that obtainable with other methods at these frequencies.
  - Dials are direct-reading in both resistance and reactance.

### SPECIFICATIONS

**Frequency Range:** 10 Mc to 165 Mc. Satisfactory operation can, for some measurements, be obtained at frequencies as low as 2 Mc and as high as 175 Mc.

**Reactance Range:**  $\pm 200$  ohms at 100 Mc. Dial range varies inversely with frequency and is calibrated at 100 Mc.

**Resistance Range:** 0 to 200 ohms, independent of frequency.

**Accuracy:** For resistance,  $\pm(2\% + 1 \Omega)$  subject to correction for inductance in the capacitor used to measure resistance. The correction increases with frequency and with the magnitude of the resistive component. A correction chart is supplied with the instrument. The ohmic uncertainty indicated in the accuracy statement, namely 1 ohm, is roughly proportional to the magnitude of the reactive component of the unknown impedance. The indicated value is the maximum obtainable, and the minimum is 0.1 ohm.

For reactance,  $\pm(5\% + 2 \Omega)$ . The ohmic uncertainty is roughly proportional to frequency and to the magnitude of the resistive component. The maximum value is indicated, and the minimum value is 0.1 ohm at 100 Mc.

**Accessories Supplied:** Two TYPE 874-R22 Cables; one TYPE 1601-204 Coaxial Extension Assembly; one TYPE

874-WN Short-Circuit Termination; one Short-Circuiting Cap; one TYPE 874-PB58 Panel Connector; Smith Charts.

**Other Accessories Required:** R-F generator and receiver covering the desired frequency range; TYPES 1208-B, 1215-B, and 1330-A Oscillators are recommended, depending on frequency range. At frequencies above 40 Mc, the TYPE DNT-1 or -2 Detector is a satisfactory receiver. Both oscillator and receiver should be reasonably well shielded. It is recommended that the receiver be fitted with the TYPE 874-PB Panel Connector supplied to avoid leakage at the input connection.

**Additional Accessories Recommended:** A TYPE 874-WM 50-ohm Termination is useful in checking the bridge adjustments. The generator and detector terminals are TYPE 874 Coaxial Connectors. Adaptors for connection to the various types of military connectors and to V-H-F and U-H-F rigid  $1\frac{5}{8}$ -inch transmission lines are listed on page 62. An additional adaptor will be needed when coaxial systems to be measured are fitted with military connectors.

**Dimensions:** (Length)  $13\frac{1}{2}$  x (height) 9 x (depth)  $10\frac{1}{2}$  inches, over-all.

**Net Weight:** 18 pounds.

Type		Code Word	Price
1601-A	V-H-F Bridge*†	FLORA	\$490.00
874-WM	50-Ohm Termination*	COAXMEETER	12.50

PATENT NOTICE. \* See Note 4, page viii. † See Note 12, page viii.

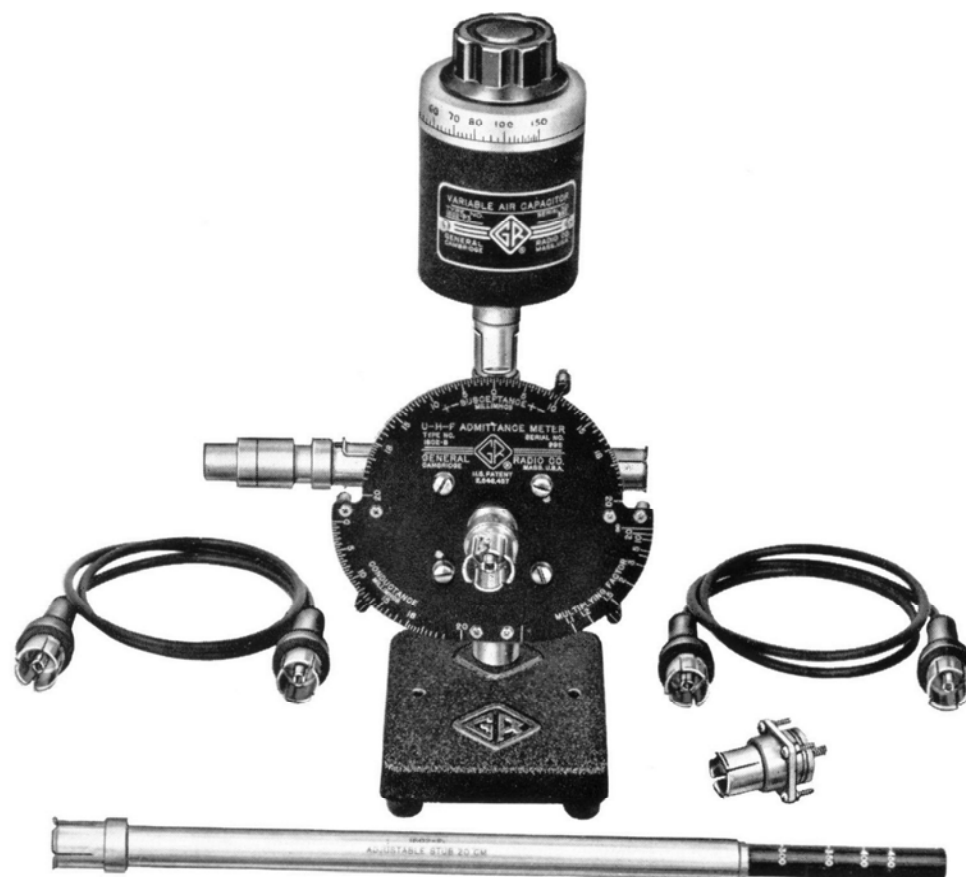

### TYPE 1602-B U-H-F ADMITTANCE METER

**USES:** The Admittance Meter is a null-type instrument for determining the components of an unknown admittance in the VHF-UHF range. It is designed primarily for measurements on coaxial systems: antennas, lines, coaxial components, etc. It can be used as an indicator for adjusting a network to a predetermined admittance or for matching one network to another and is particularly useful in matching antennas and other networks to 50-ohm circuits.

As a comparator, the Admittance Meter can be used to determine impedance magnitude, reflection-coefficient magnitude, and voltage standing-wave ratio.

The usefulness of the Admittance Meter is greatly enhanced by the many accessories available for use with it. Among these are:

The TYPE 874-LK Constant Impedance Adjustable line (page 54), which can be set to one-half wavelength to eliminate corrections for the length of transmission line between the unknown and the measuring point. When the line is set to one-quarter wavelength, the

Admittance Meter dials read directly in impedance parameters, i.e., the series resistance and reactance of the unknown.

The TYPE 874-UB Balun (page 52), for use in measuring balanced impedances, such as TV receiving antennas and transmission lines.

The TYPE 874-M Component Mount (page 59), which provides a convenient means of connecting lumped elements (resistors, capacitors, or inductors) to the Admittance Meter for measurement.

Adaptors (page 62) for all commonly used types of military connectors.

Adaptors (page 62) for Rigid VHF (1 $\frac{5}{8}$ -inch) and UHF transmission lines used with TV transmitting antennas. With these adaptors and the adjustable line mentioned above, the over-all accuracy of measurement is more than adequate for antenna measurements in design, test, and installation.

**DESCRIPTION:** The TYPE 1602-B Admittance Meter comprises a coaxial line to which the unknown is connected and has a shielded

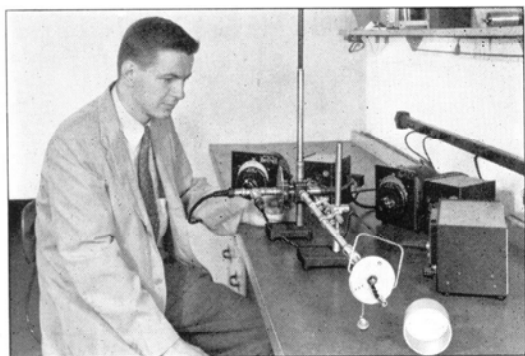

Admittance Meter set up with component mount and adjustable line to measure resistors at 500 megacycles.

pickup loop to sample the current, a second line, and loop, terminated in a pure resistance, and a third line, and loop, terminated in a pure reactance. All are fed from the same voltage source, so that their input voltages are in phase, and the current in each line is proportional to the admittance. The voltage

induced in each loop is proportional to the current in the corresponding line and is dependent upon the orientation of the loop, which is adjustable.

The three loops are connected in parallel, and the voltage from the loop in the unknown line is canceled by adjusting the loops coupled to the standard lines until a null is reached. The conductance and susceptance of the unknown are read directly from the scales of the standard loops, while the scale of the loop in the unknown line indicates multiplying factor.

- FEATURES:**
- Dial scales are direct-reading, independent of frequency.
  - No sliding balance; conductance and susceptance adjustments are independent.
  - No initial balance is necessary.
  - Wide-frequency range — direct-reading from 41 to 1500 megacycles; can be used at frequencies as low as 20 Mc.
  - Covers completely both V-H-F and U-H-F television bands.
  - Accurate, rapid, and easy to use.

**SPECIFICATIONS**

**Range:** Theoretically, zero to infinity; practically, the lower limit is determined by the smallest readable increment on the scale which is 100 micromhos (0.1 millimho). The upper limit is 1000 millimhos. Range is the same for both conductance and susceptance, but susceptance can be either positive or negative, i.e., the susceptance dial is calibrated from -20 to +20 millimhos. Multiplying factors from 1 to 20 are provided, and factors from 20 to 100 can be determined approximately.

**Frequency Range:** 41 to 1500 Mc, direct-reading. Range can be extended downward to 20 Mc, if a frequency correction is applied to the susceptance reading, and can be used to 2000 Mc for impedance matching.

**Accuracy:** For both conductance and susceptance (up to 1000 Mc):

- from 0 to 20 millimhos  $\pm(3\% + 0.2 \text{ millimho})$
- from 20 to  $\infty$  millimhos  $\pm(3\sqrt{M}\% + 0.2 \text{ millimho})$  where M is the scale multiplying factor. Above 1000 Mc, errors increase slightly, and, at 1500 Mc, the basic figure of 3% in the expression above becomes 5%. For matching impedances to 50 ohms, the accuracy is 3% up to 1500 Mc.

**Accessories Supplied:** One TYPE 1602-P4 50- $\Omega$  Termination, for use as conductance standard, and one TYPE 1602-P1 Adjustable Stub and one TYPE 1602-P3 Variable Air Capacitor, for susceptance standards; two TYPE 874-R22 Patch Cords for connections to generator and detector; and one TYPE 874-PB58 Panel Connector for installation on detector. A wooden storage case is furnished.

**Additional Accessories Required:** Generator and detector. Generator should cover desired frequency range and deliver between 1 volt and 10 volts. TYPE 1208-A (35 to 500 Mc), TYPE 1215-A (50 to 250 Mc), TYPE 1209-A (250 to 920 Mc) and TYPE 1218-A (900 to 2000 Mc) Unit Oscillators (see page 117), are recommended. The TYPE 1021-AU and AV Standard-Signal Generators are also satisfactory.

Detector sensitivity should be better than 10 micro-

volts. TYPE DNT Detectors (page 69) are recommended, consisting of the TYPE 874-MR Mixer Rectifier (page 51), the TYPE 1216-A Unit I-F Amplifier (page 68) and a second Unit Oscillator to provide the heterodyning frequency.

**Other Accessories Available:** Coaxial adaptors (page 62); line stretcher (page 54); balun (page 52); and component mount (page 59).

**Terminals:** All terminals are TYPE 874 Coaxial Connectors. Adaptors are available for other coaxial systems (page 62).

**Dimensions:** 7½ x 5½ x 5½ inches, without standards and unknown connected.

**Net Weight:** 8¼ pounds.

Schematic diagram of admittance meter circuit, with standards, generator, and null detector connected for admittance measurements.

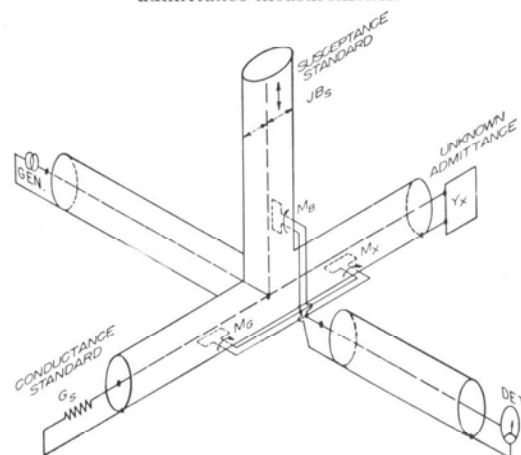

Type	Code Word	Price
1602-B	HONEY	\$295.00

PATENT NOTICE. See Note 4, page viii.



## TYPE 821-A TWIN-T IMPEDANCE MEASURING CIRCUIT



MEASURES  
HIGH IMPEDANCES  
460 kc to 40 Mc

**USES:** With the Twin-T, accurate measurements can be made of impedances having small phase differences from  $0^\circ$  or  $90^\circ$ , such as Low-loss capacitors.

Inductance and Q of coils.

Resonant impedance of parallel circuits.

Magnitude and phase angle of high-valued resistors.

In the chemical laboratory it is used for accurately determining titration end points.

**CIRCUIT AND CONSTRUCTION:** The circuit of the Twin-T minimizes the effects of unwanted residual impedances. Generator, detector, and unknown have a common ground connection, and air capacitors are used for both the capacitance and the conductance balances. The standard capacitor is a highly stable and precise model, similar to the TYPE 722 (see page 151). Capacitance and conductance dials are direct reading.

### SPECIFICATIONS

**Frequency Range:** 460 kc to 40 Mc.

**Capacitance Range:** 0 to 1000  $\mu\text{mf}$ .

**Susceptance Range:**  $-6000 \mu\text{mho}$  to  $+6000 \mu\text{mho}$  at 1 Mc. The range varies directly as the frequency, and at other frequencies the dial reading must be multiplied by the frequency in megacycles.

**Conductance Range:** Direct Reading:

0 — 100  $\mu\text{mho}$  at 1 Mc 0 — 1000  $\mu\text{mho}$  at 10 Mc

0 — 300  $\mu\text{mho}$  at 3 Mc 0 — 3000  $\mu\text{mho}$  at 30 Mc

Between these direct-reading ranges the range of the conductance dial varies as the square of the frequency.

**Accuracy:** For capacitance,  $\pm (0.1\% + 2\mu\text{mf})$ , direct-reading;  $\pm 0.1\%$  or  $\pm 0.8 \mu\text{mf}$ , whichever is larger, after scale correction data is applied. For conductance,  $\pm (2\%$  of dial reading  $+0.1\%$  of full scale). At the higher frequencies, corrections for residual impedances must be applied. All correction data is furnished.

**Accessories Supplied:** Two TYPE 874-R22 coaxial cables for connections to generator and detector; TYPE 874-PB58 Panel Connector.

**Other Accessories Required:** A suitable radio-frequency generator and a detector are required. The TYPE 1330-A Bridge Oscillator (page 110) is recommended as a generator, and a well-shielded radio receiver covering the desired frequency range is a satisfactory detector. It is recommended that the receiver be fitted with the

TYPE 874-PB58 Panel Connector supplied to avoid leakage at the input connection.

**Other Accessories Available:** For measurements on unguarded dielectric specimens, the TYPE 1690-A Dielectric Sample Holder is recommended.

**Mounting:** The instrument is mounted in a shielded, airplane-luggage type of case with carrying handle.

**Dimensions:**  $17\frac{3}{4} \times 12 \times 9\frac{1}{2}$  inches, over-all.

**Net Weight:** 29 pounds.

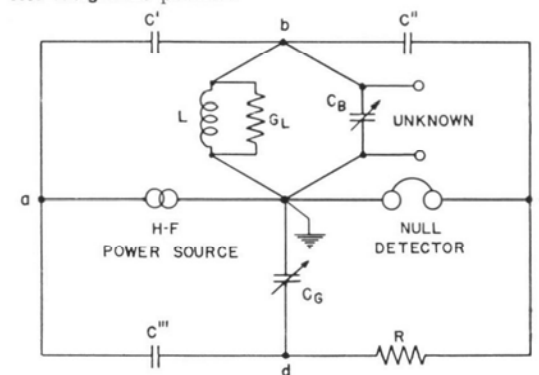

Type	Code Word	Price
821-A Twin-T.....	LAGER	\$590.00

PATENT NOTICE. See Notes 4, and 7, page viii.



## TYPE 561-D VACUUM-TUBE BRIDGE

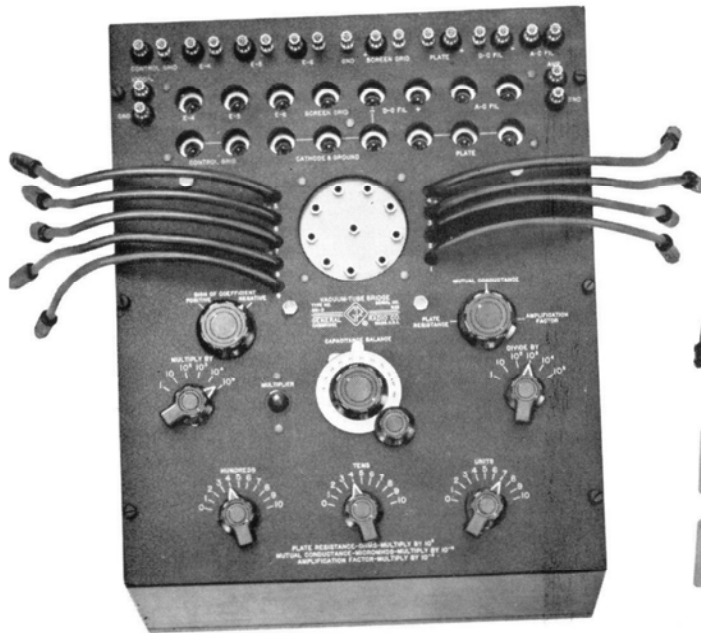

Left. Panel view of the TYPE 561-D Vacuum-Tube Bridge.

Below. Adaptors, leads and patch cords supplied with the Vacuum-Tube Bridge. These permit connection to all standard receiving tubes and transistors. Tubes with non-standard bases can also be measured using the Universal adaptor equipped with solder lugs.

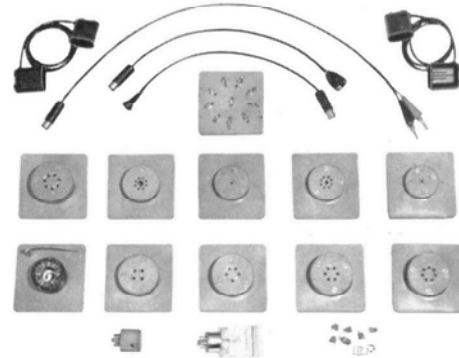

**USES:** The TYPE 561-D Vacuum-Tube Bridge makes possible the measurement of the low-frequency dynamic coefficients of vacuum tubes and transistors over very wide ranges of values and under a wide variety of operating conditions. The circuits used are such that independent, direct-reading measurements of forward and reverse voltage-amplification factor, resistance, and transconductance can be made quickly and easily. Interelectrode and other stray capacitances are balanced out in such a manner that awkward correction factors, common to most vacuum-tube bridge circuits, are unnecessary.

In the field of development and research, the instrument, in addition to providing accurate measurements of the usual parameters, affords a means of studying the behavior of tubes and transistors used in unconventional and special circuits, where any one of the electrodes may be used as the control electrode and where the parameters may have negative values.

The circuits have large enough current-carrying capacity and sufficient insulation so that low-power transmitting tubes may be tested, in addition to receiving tubes and transistors.

**DESCRIPTION:** The bridge makes use of alternating-current null methods of measurement, in which phase-shift and capacitance errors have been given special consideration in order

that the operating range of the bridge may be as wide as possible. Each of the three coefficients is obtained in terms of the ratio of two alternating test voltages. A third voltage is employed in the capacitance balancing circuit, but its value does not enter into the results.

An extremely flexible arrangement of the control circuits makes it possible to measure the parameters referred to any pair of electrodes. Connections from the tube or transistor under test to the measuring circuit are made by means of coaxial cables and jacks connected to a nine-terminal jack plate mounted on the panel. Sixteen coaxial plugs are mounted on the panel, permitting a wide variety of interconnections between the jack plate, the measuring circuit, and external power supplies.

Eleven adaptor plates are provided. Ten of these carry different standard tube sockets, and one is a "universal" adaptor furnished with soldering lugs. Socket adaptors and sockets that can be mounted on the universal adaptor are furnished for sub-miniature tubes and transistors.

**FEATURES:** ➤ A simple and straightforward measurement procedure is used and is exactly the same for all three coefficients. A three-position switch is turned to the desired quantity, multiplier switches are set at the appropriate value, and a null balance is obtained by adjusting a three-decade attenuator and a

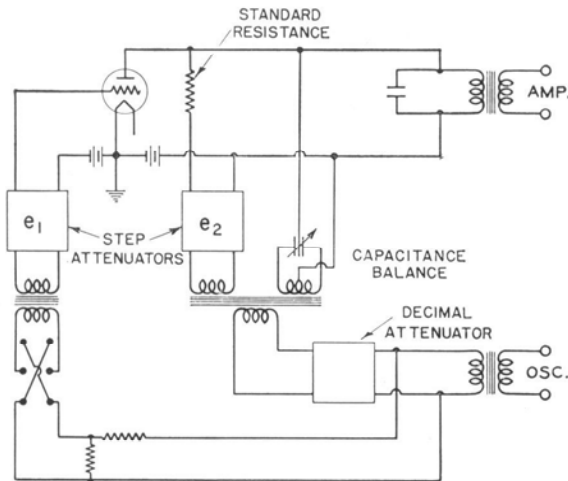

Simplified diagram of the circuit employed for the measurement of transconductance with the TYPE 561-D Vacuum-Tube Bridge. The a-c plate current resulting from the application of  $e_1$  to the grid is balanced by an equal and opposite current applied to the plate from the source  $e_2$ , through the standard resistance. The setting of the decimal attenuator at the bottom of the panel gives the significant figures in the result, and the settings of the step attenuators ( $e_1$  and  $e_2$ ) indicate multiplying factors (MULTIPLY BY and DIVIDE BY on the panel switches).

Any quadrature component through the output transformer resulting from the tube interelectrode capacitance can be balanced out by the voltage of the extra split secondary, acting through the double-stator capacitor. This balance does not affect the balance conditions for the in-phase components and consequently has no effect on the measurement.

The points of introduction of the test voltages  $e_1$  and  $e_2$  are changed by a switch when the other coefficients are measured. Another switch reverses the polarity of  $e_1$  when negative values of the coefficients are to be measured.

variable capacitor. At balance, the decades read the quantity being measured directly to three significant figures.

- Independent measurements of the three main parameters are possible, i.e., none of the balances depends in any way on any other. Therefore independent cross checks can be obtained from the known relationship involving the three coefficients ( $\mu = r_p g_m$ ).
- Negative values of the coefficients can be measured as readily as positive values.

- Interelectrode capacitance effects are balanced out by a method which makes possible the independent measurement of all three parameters over very wide ranges. Errors have thus been reduced, and it is possible to measure the transconductance of a tube having a high value of grid to plate capacitance without any error from this capacitance.
- Transistors can be measured as well as vacuum tubes.

SPECIFICATIONS

**Range:** Amplification factor ( $\mu$ ), 0.001 to 10,000.  
Dynamic internal plate resistance ( $r_p$ ), 50 ohms to 20 megohms.

Transconductance ( $g_m$ ), 0.02 to 50,000 micromhos.  
Under proper conditions, the above ranges can be exceeded. The various parameters can also be measured with respect to various elements, such as screen grids, etc. Negative as well as positive values can be measured.

**Accuracy:** Within  $\pm 2\%$  for resistances ( $r_p$  switch position) from 1000 to 1,000,000 ohms. At lower and higher values the error increases slightly.

The expression  $\mu = r_p g_m$  will check to  $\pm 2\%$  when the quantities are all measured by the bridge, and when  $r_p$  is between 1000 and 1,000,000 ohms.

**Tube Mounting:** Adaptors are provided as follows: 4-pin, 5-pin, 6-pin, small 7-pin, large 7-pin, octal, loctal, miniature button 7-pin, miniature button 9-pin (noval), acorn (5- and 7-pin), flat-press sub-miniature up to 7 wires, and 8-wire sub-minar. In addition, a universal adaptor, with nine soldering lugs, is provided so that unbased transistors, unmounted tubes, or tubes with non-standard bases, can be measured conveniently. For short-lead sub-miniature tubes and for transistors, sockets are supplied which can be mounted on the universal adaptor. Thus all standard commercial receiving tubes and transistors can be measured. The panel jack plate and the adaptors are made of yellow phenolic, reducing to a minimum the shunting effect of dielectric losses on the dynamic resistance being measured.

**Current and Voltage Ratings:** The circuits have large enough current-carrying capacity and sufficient insulation so that low-power transmitting tubes may be tested in addition to receiving tubes and transistors. Maximum allowable plate current is 150 ma, and maximum plate voltage is 1500 volts.

**Electrode Voltage Supply:** Batteries or suitable power supplies are necessary for providing the various voltages required by the device under test.

**Bridge Source:** A source of 1000 cycles is required. The TYPE 1214-A Oscillator (page 112), or the TYPE 723-A Vacuum-Tube Fork (page 109) is suitable for this purpose.

**Null Indicator:** The TYPE 1212-A Unit Null Detector with the TYPE 1951-A Filter or the TYPE 1231-B Amplifier with the TYPE 1231-P2 Filter are recommended (see pages 63 to 67).

**Accessories Supplied:** Adaptors as listed above, all necessary plug-in leads, and shielded patch cords for connecting generator and detector.

**Mounting:** The instrument is mounted in a walnut cabinet. A wooden storage case is provided for the adaptors and leads. Storage space is provided for a spare Universal adaptor, on which any type of socket can be permanently mounted.

**Dimensions:** (Length)  $18\frac{3}{8}$  x (width)  $15\frac{3}{4}$  x (height) 12 inches.

**Net Weight:** 60 pounds.

Type	Code Word	Price
561-D   Vacuum-Tube Bridge.....	BEIGE	\$795.00



# COAXIAL ELEMENTS

The TYPE 874 Coaxial Elements are a group of inexpensive, but precision-built, coaxial parts that can be plugged together quickly and easily to assemble different measuring systems in the frequency range from d-c to 5000 megacycles.

The fundamental tools are a slotted line for impedance and standing-wave-ratio measurements, a crystal rectifier and indicator for voltage measurements, a bolometer bridge for power measurements, and a balun for balanced measurements. A motor drive makes the slotted line automatic in operation. These basic devices are supplemented by all the necessary accessory parts listed in the index below.

The keystone of the entire system is the TYPE 874 Coaxial Connector. This unique connector, any two of which, although identical, can be plugged together, is specifically designed for use on coaxial measuring equipment. Its quick-connect-and-disconnect feature simplifies the assembly of coaxial elements into complete measurement setups, and its reflections at ultra-high frequencies are so low that they can be neglected except in very precise work (see graph, below).

A minimum of parts is necessary to assem-

ble any given setup since all connectors are identical, eliminating the need for both male and female connectors. For connection to devices equipped with other types of connectors, a complete line of low-reflection adaptors is available.

The basic elements of the TYPE 874 Coaxial Connector are an inner conductor, an outer conductor, and a supporting polystyrene bead. Figure 1 shows one of these connectors assembled at the end of a rigid, 50-ohm, air-dielectric, coaxial line. The inner and outer conductors are similar in principle; each is essentially a tube with four longitudinal slots in the end and with two opposite quadrants displaced inward. To make a joint, two connectors are plugged together so that the undisplaced quadrants of one connector overlap the displaced quadrants of the other. Figure 2 is a cross-section sketch of a joint in which the elements of one connector are shaded dark and those of the other light. The mutual overlapping referred to can be seen, as well as the resultant circularity of the joined conductors.

**Maximum Input Voltage:** 1.5 kilovolts.

**Maximum Input Power:** 150 watts at 1000 Mc. Power is inversely proportional to the square root of frequency.

## INDEX

	Page		Page
Adaptors.....	62	Lines and Line Elements.....	54
Attenuators.....	57	Mixer-Rectifier.....	51
Balanced Measurements.....	52	Motor Drive for Slotted Line.....	48
Balun.....	52	Patch Cord.....	60
Bolometer.....	50	Power Measurements.....	50
Cable.....	60	Slotted Line.....	46
Cliplock.....	59	Stand.....	59
Component Mount.....	59	Stubs.....	56
Connectors.....	61	Terminations.....	55
Couplers.....	56	Tuning Elements.....	56
Filters.....	58	Voltage Measurements.....	49
Insertion Unit.....	59		

PATENT NOTICE. See Note 4, page viii.

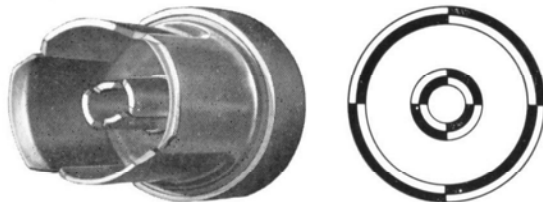
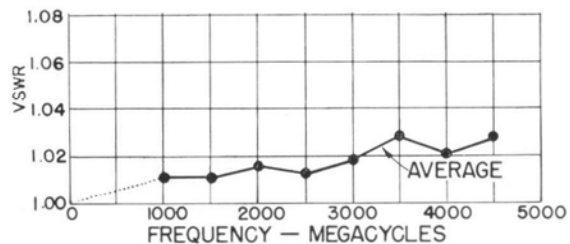

Figure 1. Photograph and, Figure 2, cross-section sketch of TYPE 874 Coaxial Connector.



TYPE 874 Connector standing-wave ratio as a function of frequency.



EQUIPMENT FOR STANDING WAVE MEASUREMENTS

TYPE 874-LBA SLOTTED LINE

**USES:** One of the most important basic measuring instruments used at UHF is the slotted line. With it, the standing-wave pattern of the electric field in a coaxial transmission line can be measured, from which the standing-wave ratio, phase of the reflected wave, impedance of the load, wavelength of the R-F signal, losses in attached elements, degree of mismatch between load and line, and other characteristics of antennas, components, coaxial elements and networks can be determined.

With the TYPE 874-MD Slotted-Line Motor Drive, standing-wave patterns can be displayed and measured directly on an oscilloscope, with a great increase in speed of measurement.

**DESCRIPTION:** The slotted line is a 50-ohm, air dielectric, coaxial transmission line, whose electric field is sampled by a probe that projects through a longitudinal slot in the line.

A source of r-f power of about one milliwatt is usually adequate for most measurements.

A crystal, built into a sliding carriage, detects the r-f voltage induced in the probe when tuned to the operating frequency by an adjustable stub. The output of the crystal can be measured by a d-c microammeter or a calibrated audio-frequency amplifier. The microammeter has limited usefulness due to its low

sensitivity. The audio amplifier system — TYPE 1231-B Amplifier, TYPE 1231-P4 Calibrated Attenuator and TYPE 1231-P2 Filter — combines simplicity and adequate sensitivity for most measurements. An amplitude-modulated r-f signal is required for this method.

A receiver or heterodyne detector is an excellent device for measuring the voltage induced in the probe. The TYPE DNT series of detectors are well-suited to this application because they provide excellent sensitivity, a high degree of selectivity, and a very wide range of linear response. This detector is particularly well adapted to measurements of very high standing-wave ratios, and its high selectivity makes it useful for measurements of non-linear elements. It is recommended for general use except where simplicity of operation and first cost are the controlling factors.

- FEATURES:**
- Well designed, precisely constructed, capable of accurate measurements.
  - Sturdiness and light weight make it convenient for field use.
  - Can be motor driven for automatic operation (see page 48).
  - Wide variety of accessory coaxial units available, all fitted with TYPE 874 Coaxial Connectors (see following pages).

SPECIFICATIONS

- Characteristic Impedance:** 50 ohms  $\pm$  1%.
- Probe Travel:** 50 cm, scale calibrated in millimeters.
- Frequency Range:** 300 to 5000 Mc; Operation below 300 Mc is possible using lengths of TYPE 874 Air Lines.
- Dielectric:** Air.
- Accuracy:** Constancy of probe penetration,  $\pm$  1 1/2%.
- Residual VSWR:** Less than 1.025 at 1000 Mc, less than 1.07 at 4000 Mc.
- Accessories Supplied:** Storage box and spare drive cable.
- Accessories Required:** Adjustable Stub (TYPE 874-D20) for tuning the crystal rectifier when audio-frequency detector is used; suitable detector and generator (see

- page 47); one each TYPE 874-R22 Flexible Line and TYPE 874-R32A Patch Cord for generator and detector connections.
- Accessories Available:** See index on preceding page. A complete kit of TYPE 874 Coaxial elements for use with the slotted line is described on the next page. For measurement of high VSWR (greater than 10), a TYPE 874-LV Micrometer Vernier is recommended. For rapid measurements, use the TYPE 874-MD Slotted-Line Motor Drive.
- Dimensions:** 26 x 4 1/2 x 3 1/2 inches overall.
- Net Weight:** 8 1/2 pounds.

View of TYPE 874-LBA Slotted Line with TYPE 874-LV Micrometer Vernier.

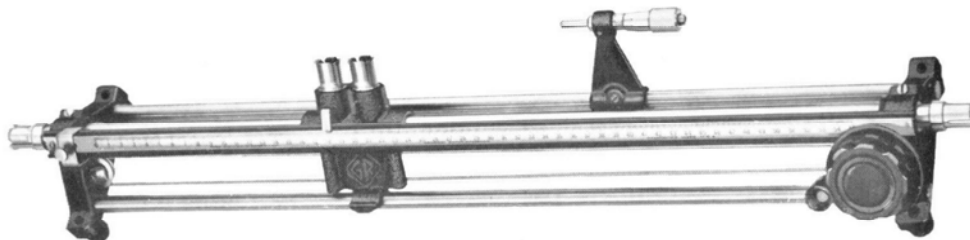

Type	Code Word	Price
874-LBA   Slotted Line.....	COAXRUNNER	\$220.00



## RECOMMENDED GENERATORS AND DETECTORS FOR THE SLOTTED LINE

### GENERATORS

The following generators are recommended: (TYPE 1021-AU, AV, or AW Standard Signal Generators are also satisfactory)

Type		See Page	Price
1208-B	Unit Oscillator, 65-500 Mc....	117	\$200.00
1209-B	Unit Oscillator, 250-920 Mc....	117	235.00
1218-A	Unit Oscillator, 900-2000 Mc..	117	465.00
1220-A	Unit Oscillator, 2700-7425 Mc..	118	*

The above unit oscillators do not include power supply; the TYPE 1203-A Unit Power Supply is recommended for general use. Where line voltage is subject to frequent variations, the TYPE 1201-A Unit Regulated Power Supply should be used.

1203-A	Unit Power Supply.....	144	40.00
1201-A	Unit Regulated Power Supply...	145	80.00

If a modulated signal is desired, the TYPE 1214-A Unit Oscillator for sine waves and the TYPE 1210-B Unit Oscillator for either sine waves or square waves are recommended to supply the modulating signal.

1214-A	Unit Oscillator.....	112	68.00
1210-B	Unit R-C Oscillator.....	114	165.00

\* Price depends upon frequency, see page 118.

### DETECTORS

The TYPE 1231-BM Amplifier and Null Detector (page 64) or TYPE DNT Detector (page 68) is recommended. The TYPE 1231-BM is less expensive, covers the entire frequency range of the slotted line, and has, with the output detector in the slotted line, an expanded scale useful for low standing-wave ratios; it requires a modulated signal. The TYPE DNT is more sensitive, more selective, and does not require a modulated signal; it is particularly well suited for measurement of very high standing-wave ratios.

Type		Price
1231-BM*		\$250.00
1231-P2	Filter (page 65).....	30.00
1231-P4	Adjustable Attenuator (page 60)	70.00
874-D20	Stub (page 60).....	14.00
874-R32A	Patch Cord (page 56).....	5.50
	Total for Type 1231-BM and accessories.....	369.50
DNT-1	35 to 530 Mc.....	\$615.00
DNT-3	220 to 950 Mc.....	648.00
DNT-4	870 to 2030 Mc †.....	864.00

\* Battery-operated model. An a-c-operated model is also available.  
† Up to 5000 Mc by use of harmonics.

### MICROMETER VERNIER ATTACHMENT

If very high standing-wave ratios (greater than 10) are to be measured, a TYPE 874-LV Micrometer Vernier Attachment should also be purchased as well as a harmonic filter.

For use in the measurement of high-standing wave ratios by the width-of-minimum method. Consists of

a micrometer caliper head, calibrated in centimeters (graduated to 0.001 cm), mounted on an arm that can be attached to the rear base rod of the slotted line. One turn of the micrometer barrel advances the head by 0.5 millimeter. Maximum range is 2 cm. Can be read to  $\pm 0.0005$  cm.

Type		Price
874-LV	Micrometer Vernier Attachment.....	\$25.00
874-F500	Low-Pass Filter (page 58).....	16.00
874-F1000	Low-Pass Filter (page 58).....	14.00
874-F2000	Low-Pass Filter (page 58).....	14.00
874-F4000	Low-Pass Filter (page 58).....	14.00

### BASIC SLOTTED LINE KIT

For impedance and standing-wave measurements with the slotted line, a group of coaxial elements has been selected and is available as the TYPE 874-EK Basic Coaxial Kit. The following items are included.

Type	Name	Quantity	Unit Price	Price
874-A2	Coaxial Cable.....	25 feet	\$27.00/100 feet	\$ 6.75
874-B	Basic Connector.....	2	1.15	2.30
874-C	Cable Connector.....	2	1.70	3.40
874-C8	Cable Connector.....	2	1.70	3.40
874-D20	Adjustable Stub.....	1	14.00	14.00
874-D50	Adjustable Stub.....	1	14.00	14.00
874-LA	Adjustable Line.....	1	17.50	17.50
874-LBA	Slotted Line.....	1	220.00	220.00
874-P	Panel Connector.....	2	2.75	5.50
874-QNJ	Adaptor to Type N Jack.....	1	3.75	3.75
874-QNP	Adaptor to Type N Plug.....	1	4.50	4.50
874-R20	Flexible Line (Patch Cord).....	2	6.50	13.00
874-R32A	Patch Cord.....	1	5.50	5.50
874-T	Tee.....	1	8.50	8.50
874-WM	Matched (50 ohm) Termination.....	1	12.50	12.50
874-WN	Short-Circuit Termination.....	1	2.50	2.50
874-WO	Open-Circuit Termination.....	1	1.75	1.75
874-Z	Stand.....	1	15.00	15.00
<b>TOTAL</b>	<b>Type 874-EK Basic Coaxial Kit.....</b>			<b>\$353.85</b>



## TYPE 874-MD SLOTTED LINE MOTOR DRIVE

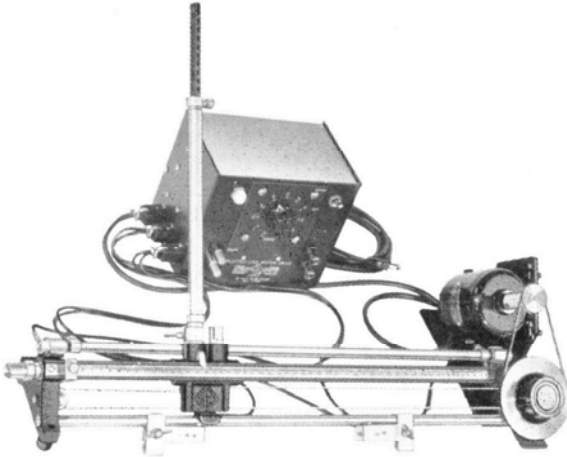

**USES:** The motor drive provides an automatic cyclic sweep of the probe carriage along the TYPE 874-LBA Slotted Line, so that the standing-wave pattern can be displayed on a cathode-ray oscillograph. The resultant speeding-up of the measurement process saves valuable engineering time in the laboratory and makes it possible to utilize the inherent accuracy of slotted-line methods in production testing. Both VSWR and position of minimum can be read directly from the scope pattern. At lower sweeping speeds a VSWR meter indication can be used.

**DESCRIPTION:** The driving motor attaches easily to the right-hand end of the slotted line and drives the probe

carriage by means of a V-belt and a pulley that replaces the control knob on the slotted line. The pulley is equipped with a knob, so that manual operation is also possible. A synchronized horizontal-sweep voltage is generated by a linear sweep potentiometer that attaches to the back of the slotted line, with a sliding contact element attached to the carriage. Microswitches, mounted on movable brackets, determine the travel of the carriage and provide the reversing control. The motor-control circuits are housed in a separate cabinet, connected to the slotted-line assembly by plug-in cables. The control system is similar to the TYPE 1701-AK Variac® Speed Control (page 221).

The entire unit can be installed on the slotted line in less than 5 minutes.

The standing-wave pattern appearing on the oscilloscope depends upon the type of modulation of the r-f source. The oscilloscope should be equipped with d-c amplifiers. Square-wave modulation, which provides a base line on the scope for direct VSWR measurements, is the preferred method of excitation. Either sine-wave modulation or an unmodulated generator, however, will also yield completely satisfactory results, and a clamping circuit to provide the base line is furnished as an accessory. The table below lists recommended combinations of equipment for all three methods.

**FEATURES:** ➤ Time saver for both production line and laboratory.

➤ Makes possible highly accurate direct-reading VSWR measurements.

➤ Adjustable sweep speed and sweep length.

➤ Can be used with standing-wave meter at slow speeds.

➤ Oscilloscope grid overlay provided for direct indication of VSWR.

### SPECIFICATIONS

**Length of Sweep:** Adjustable, 1 cm to 47 cm.

**Sweep Speed Range:** For complete sweep (47 cm), from one sweep in 20 seconds to better than 1 per second; for shorter sweeps to 5 per second.

**Maximum Horizontal Sweep Voltage:** 7 volts.

**Accessories Supplied:** Cables for connections; clamping circuit; 5-inch oscilloscope mask with VSWR scale; two TYPE 274-NCO Patch Cords; spare subminiature switch; spare actuator; spare cushioned sliding contact; spare fuses.

**Power Supply:** 115 volts, 50 to 60 cycles.

**Net Weight:** 16¾ pounds.

**Other Equipment Required:** One TYPE 874-G10 Fixed Attenuator, one 30-kilohm resistor, generator and detector as listed below:

Type	Code Word	Price
874-MD Slotted-Line Motor Drive	STORY	\$280.00
874-G10 Fixed Attenuator (10db)	COAXBELLER	25.00

Method	Generator	Modulator	Frequency Range	Detector * Arrangement
Square-Wave Modulation	TYPE 1218-A Unit Oscillator TYPE 1220-A Unit Klystron Oscillator	TYPE 1210-B Unit Oscillator None	900-2000 Mc 2700-7450 Mc	Oscilloscope † (10 mv/in. d-c sensitivity)
Sine-Wave Modulation	TYPE 1208-B Unit Oscillator TYPE 1209-B Unit Oscillator TYPE 1218-A Unit Oscillator	TYPE 1214-A Unit Oscillator or TYPE 1210-B Unit Oscillator	65-500 Mc 250-920 Mc 900-2000 Mc	Oscilloscope † (0.1v in. d-c sensitivity), or TYPE 1231-B Amplifier and Null Detector (page 64) and Clamping circuit (supplied)
Unmodulated Source	TYPE 1208-B Unit Oscillator TYPE 1209-B Unit Oscillator TYPE 1218-A Unit Oscillator TYPE 1220-A Unit Klystron Oscillator	None	65-500 Mc 250-920 Mc 900-2000 Mc 2700-7450 Mc	Oscilloscope † (10 mv/in. d-c sensitivity)

\* Alternatively, one of the TYPE DNT Heterodyne Detectors (page 68) will provide a linear, as contrasted with a square-law, oscilloscope display.

† A high-persistence oscilloscope screen (P7 Phosphor) is recommended.



## EQUIPMENT FOR VOLTAGE MEASUREMENTS

### Type 874-VR Voltmeter Rectifier

The Voltmeter Rectifier, in conjunction with the Voltmeter Indicator, will measure or monitor the voltage in coaxial systems. It can, for instance, be used to convert a well-shielded oscillator to a standard-signal generator. It is also useful as a general-purpose detector.

**Maximum Voltage:** 2 volts.

**Crystal:** TYPE 1N21B.

**Resonant Frequency:** Approximately 3600 megacycles; correction curve supplied.

**By-Pass Capacitance:** Approximately 300  $\mu\text{f}$ ; shunt capacitance of crystal, approximately 1  $\mu\text{f}$ .

**Frequency Range for Voltage Measurements:** 15 Mc to 2500 Mc, subject to resonance correction above 500 Mc. Voltage indications and correct voltage ratios can be obtained at both lower and higher frequencies. See curve.

**Dimensions:** (Length)  $3\frac{3}{4}$  x (height)  $2\frac{1}{2}$  inches.

**Net Weight:** 5 ounces.

Type	Code Word	Price
874-VR   Voltmeter Rectifier . . .	COAXRECTOR	\$30.00

### Type 874-VQ Voltmeter Detector

The Voltmeter Detector can be used as a voltmeter, a demodulator, and a detector. It can be inserted in a 50-ohm coaxial line without introducing an appreciable discontinuity, or, when itself terminated in the TYPE 874-WM Matched Termination, it can be used as a matched detector to terminate a line.

The TYPE 874-VQ Voltmeter Detector is similar to the TYPE 874-VR Voltmeter Rectifier, but the series resistor is omitted, and matching elements are included to compensate for the discontinuity caused by the capacitance of the crystal. This detector is used in the measurement of network frequency response with the TYPE 1750-A Sweep Drive and the TYPE 1263-A Amplitude Regulating Power Supply. (See page 200.)

It can also be used with the Voltmeter Indicator for voltage measurements.

**Maximum Voltage:** 2 volts.

**Resonant Frequency:** Approximately 3600 Mc; correction curve supplied.

**VSWR Introduced in a Matched 50-ohm Line:** Less than 1.1 at 1000 Mc, less than 1.2 at 2000 Mc.

### Type 874-VI Voltmeter Indicator

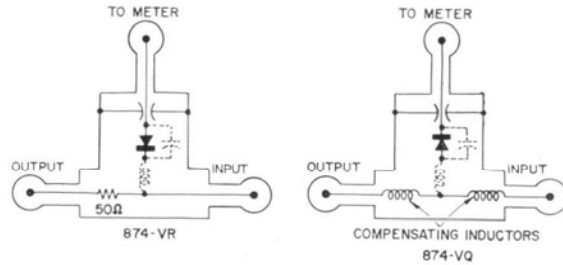

Schematics (above) and average correction factor (below) for TYPES 874-VR and -VQ.

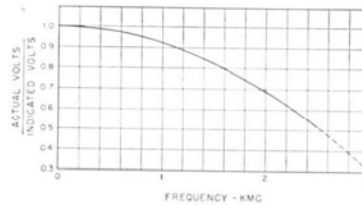

**By-Pass Capacitance:** Approximately 300  $\mu\text{f}$ .

**Frequency Range for use as Matched Detector:** 500 kc to 2000 Mc. Can be used at frequencies up to 5000 Mc and down to 60 cycles (with external by-pass capacitor).

**Crystal:** 1N23-BR Reversed Crystal to provide proper output polarity for use with d-c oscilloscopes.

**Frequency Response:** Similar to TYPE 874-VR Voltmeter Rectifier up to 2500 Mc. When the TYPE 874-VR Voltmeter Rectifier and TYPE 874-VQ Voltmeter Detector are used in swept frequency-response measurements with the TYPE 1750-A Sweep Drive and TYPE 1263-A Amplitude Regulating Power Supply, the resonance effects in the two voltmeters cancel and the output is a direct measure of the network under test up to 2000 Mc.

**Dimensions:**  $3\frac{3}{4}$  x  $2\frac{1}{2}$  inches.

**Net Weight:** 5 ounces.

Type	Code Word	Price
874-VQ   Voltmeter-Detector . . .	COAXVOQUER	\$30.00

Indicates the rectified d-c output of either the Voltmeter Rectifier or Detector and provides means for measuring the voltage at any level between 0.1 volt and 2 volts. A built-in 60-cycle calibration system eliminates errors arising from differences in crystal rectification efficiencies.

**Range and Accuracy of Calibrating Voltage:** 0.1-2 volts  $\pm$  0.05 volts.

**Crystal Current for Full-Scale Indication:** 200  $\mu\text{a}$ .

**Power Supply:** 105 to 125 volts, 50 to 60 cycles.

**Input Resistance:** 600 ohms, minimum; 10,000 ohms, maximum.

**Accessories Supplied:** TYPE CAP-35 Power Cord.

**Other Accessories Required:** Order one TYPE 874-R32A Patch Cord to connect rectifier to indicator.

**Dimensions:**  $5\frac{1}{2}$  x  $5\frac{1}{2}$  x  $4\frac{1}{2}$  inches, over-all.

**Net Weight:** 3 pounds, 1 ounce.

Type	Code Word	Price
874-VI   Voltmeter Indicator . . .	COAXVOLTER	\$70.00
874-R32A   Patch Cord . . . . .	COAXPITTER	5.50



## EQUIPMENT FOR POWER MEASUREMENTS TYPE 1651-A BOLOMETER BRIDGE



**USES:** The Bolometer Bridge is a general-purpose instrument for measuring r-f power.

It is intended for use with General Radio TYPE 874-H25 and TYPE 874-H100 Thermistor Units and with TYPE 874-HF Fuse Bolometer, but is equally usable with bolometers of other makes.

In conjunction with a General Radio Type 874-LBA

Slotted Line, the bridge can be used for calibrating r-f voltmeters and checking the output of standard-signal generators. It can also be used to measure the resistance of non-linear elements.

**DESCRIPTION:** The circuit is a d-c Wheatstone bridge with the bolometer element in one arm. The bridge is supplied by a transformer and rectifier system, fed from the 60-cycle line, through a VARIAC® autotransformer.

In the d-c substitution method of measurement, the bridge is first balanced with r-f current in the bolometer, the r-f power is removed, and the bridge rebalanced by increasing the d-c bolometer current. R-F power is then the product of dial and meter readings.

All quantities are noted after the final balance has been made and after the r-f power has been removed, which eliminates errors due to changes in the r-f power level while readings are being taken and thus tends to improve the accuracy.

In the direct-reading method, the meter scale is standardized in terms of a substitution measurement, after which it reads applied r-f power directly.

Condensed operating instructions are mounted on the panel.

**FEATURES:** ➤ Can be adapted to a variety of r-f power-measurement problems.

➤ Bolometers or power-sensitive elements having a wide range of resistance can be used.

➤ Measurements can be made by either a direct-reading or a substitution method.

➤ Measures power up to 0.5 watt directly.

### SPECIFICATIONS

**Range and Accuracy — Substitution Method**

With TYPE 874-H25 Thermistor Unit

Thermistor resistance set for max. sensitivity . . . . . 6 mw ± (10% + 0.05 mw)

Thermistor resistance set at 50 ohms . . . . . 18 mw ± (10% + 0.12 mw)

With TYPE 874-H100 Thermistor Unit

Thermistor resistance set for max. sensitivity . . . . . 20 mw ± (10% + 0.15 mw)

Thermistor resistance set at 50 ohms . . . . . 70 mw ± (10% + 0.5 mw)

With TYPE HF Fuse Bolometer 1/32-ampere fuse

Fuse resistance set for max. sensitivity . . . . . 8 mw ± (10% + 0.1 mw)

Fuse resistance set at 50 ohms . . . . . 14 mw ± (10% + 0.15 mw)

Fuse resistance set for max. power range . . . . . 50 mw ± (10% + 0.3 mw)

With TYPE 874-HF Fuse Bolometer 1/12-ampere fuse

Fuse resistance set for max. sensitivity . . . . . 20 mw ± (10% + 0.5 mw)

Fuse resistance set at 50 ohms . . . . . 100 mw ± (10% + 0.75 mw)

Fuse resistance set for max. power range . . . . . 500 mw ± (10% + 3 mw)

**Direct-Reading Method:** Accuracy depends upon the error caused by non-linearity of the power-vs.-meter deflection relationship, which is added to the 10% tolerance of the substitution method. The curves at the right show the ranges of measurement for an overall accuracy of ± 20% (10% non-linearity).

**Bolometer Resistance Range:** 25 to 460 ohms.

**Current Range:** 0 to 100 milliamperes.

**Power Supply:** 105-125 volts, 60 cycles.

**Frequency Range:** Determination of power is independent of frequency. Practical range:

5 — 4000 Mc with thermistor units.

5 — 1060 Mc with fuse units.

**Accessories Supplied:** One CAP-35 Power Cord; one TYPE 274-NEO Patch Cord; spare fuses.

**Accessories Required:** Bolometer element, TYPES 874-H25 and 874-H100 Thermistor Units, and TYPE 874-HF Fuse Bolometer Holder are recommended.

**Dimensions:** 12 x 12 x (depth) 8 3/4 inches, over-all.

**Net Weight:** 22 1/4 pounds.

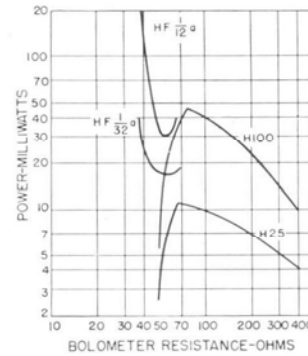

Type	Code Word	Price
1651-A Bolometer Bridge . . . . .	BEGIN	\$325.00
1651-AQ6 Bolometer Bridge (115 volts, 50 cycles) . . . . .	BEGINPASHA	425.00
1651-AQ11 Bolometer Bridge (230 volts, 50 cycles) . . . . .	BEGINREGAL	385.00



**BOLOMETERS**

**Type 874-H25 Thermistor Unit  
(25 mw)**

Consists of a TYPE 874-HP25 Thermistor mounted in a coaxial holder with a disc-type by-pass capacitor. Binding posts are provided for connections to bolometer bridge. Can be used for power measurements over the frequency range from 5 Mc to about 4000 megacycles. A d-c path is required in the r-f source. Complete with thermistor.

**By-Pass Capacitance:** Approximately 2000  $\mu\text{mf}$ .  
**Physical Length Over-all:**  $3\frac{3}{4}$  inches.  
**Maximum Total Power:** 25 mw.

**Type 874-H100 Thermistor Unit  
(100 mw)**

Similar to TYPE 874-H25, with maximum power rating of 100 mw. Complete with TYPE 874-HP100 Thermistor. Physical Length Over-all:  $3\frac{3}{4}$  inches.

**Type 874-HF Fuse Bolometer Holder**

A coaxial holder for fuse bolometers 1 inch long by  $\frac{1}{4}$  inch diameter (SAG size). Otherwise similar to the thermistor units described above. Supplied with one TYPE 874-HF-P1 Fuse Assortment consisting of five  $\frac{1}{2}$ -amp fuses and five  $\frac{1}{32}$ -amp fuses.

**Maximum Frequency Limit:** Approximately 1000 Mc.  
**By-Pass Capacitance:** Approximately 2000  $\mu\text{mf}$ .  
**Physical Length Over-all:** 4 inches.

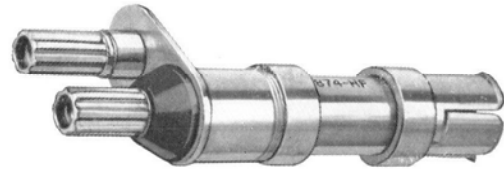

TYPE 874-HF Fuse Bolometer Holder

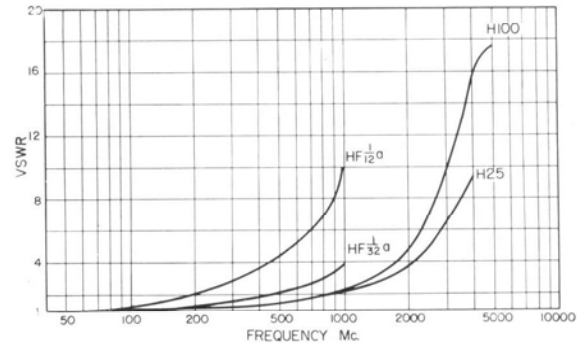

VSWR of the Fuse Bolometer and Thermistor Units as a function of frequency, with d-c resistance set at 50 ohms.

Type	Description	Code Word	Price
874-H25	Thermistor Unit.....	COAXWARMER	\$29.50
874-HP25	Replacement Thermistor for Type 874-H25.....	THERM	15.00
874-H100	Thermistor Unit.....	COAXHEATER	28.00
874-HP100	Replacement Thermistor for Type 874-H100.....	CALDO	13.00
874-HF	Fuse Bolometer Holder.....	COAXHOLDER	18.00
874-HF-P1	Fuse Assortment.....	FUSOR	3.50
274-NEO	Patch Cord (for connection between bolometer bridge and bolometer units).....	STAPLUGEYE	5.00

**TYPE 874-MR MIXER-RECTIFIER**

**DESCRIPTION:** The TYPE 874-MR Mixer Rectifier consists of a short coaxial line with a 250-ohm series resistor and a crystal rectifier terminated in a low-pass filter having a cut-off frequency of 40 Mc.

It is used as the first detector in a heterodyne frequency converter and permits the TYPE 1216-A Unit Amplifier\* (page 68) to be employed as a detector for u-h-f measurements. The high-frequency signal, which may have a frequency between 50 and 5000 Mc, is mixed with a signal from a local oscillator to produce a difference frequency below 40 megacycles, which is then fed to i-f amplifier. The heterodyning signal of the local oscillator may be either the fundamental frequency or one of its harmonics.

The 250-ohm series resistor isolates the signal circuit from the local oscillator circuit.

When used with TYPE 874-G10 or -G20 Attenuator Pad, the Mixer Rectifier becomes a well-matched 50-ohm detector.

**SPECIFICATIONS**

**Operating Frequency Range:** 50 to 5000 Mc, and at lower and higher frequencies with decreased sensitivity.

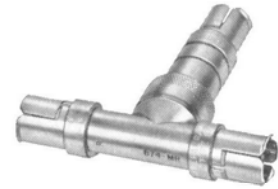
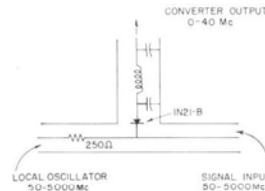

**Maximum Crystal Current:** 5 ma.  
**Maximum Input from Local Oscillator:** 2 volts.  
**Cut-Off Frequency of Output Filter:** 40 Mc.  
**Conversion Loss at 30-Mc Output:** Depends upon load impedance and is about 6 db with the TYPE 1216-A Unit I-F Amplifier when local oscillator fundamental is used.  
**Accessories Required:** Local oscillator for heterodyning (all Unit Oscillators are recommended). Patch cords as indicated in the diagram of page 116 are needed for connections. The TYPE 1216-A 30-Mc Unit I-F Amplifier (page 68) is recommended as a detector. For complete detector assembly, see page 69.

Type	Description	Code Word	Price
874-MR	Mixer Rectifier.....	COAXVERTER	\$32.50

\*Other i-f amplifiers or receivers can also be used.



**EQUIPMENT FOR BALANCED MEASUREMENTS**

**TYPE 874-UB  
BALUN**

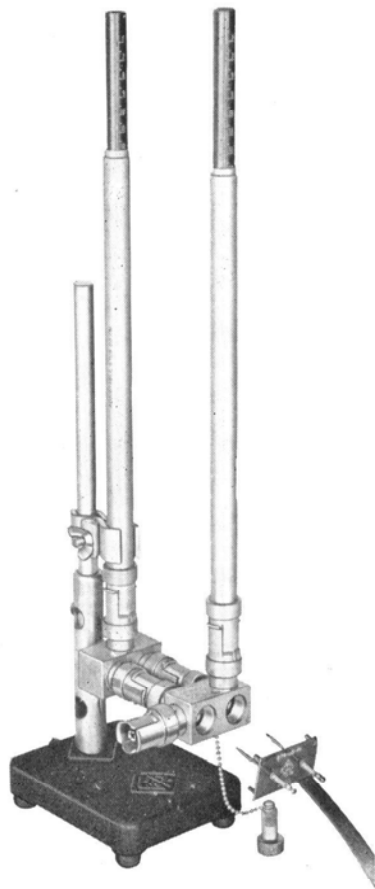

**USES:** The TYPE 874-UB Balun is a tuned, balanced-to-unbalanced, coaxial transformer that makes possible the measurement of impedance, voltage standing-wave ratios, attenuation, gain, and sensitivity of balanced devices, using generally available unbalanced measuring equipment. When used with the TYPE 874-LBA Slotted Line or the TYPE 1602-B Admittance Meter, it permits balanced measurements over a frequency range from 54 to 1000 Mc without appreciable insertion loss or transformation error. When the balun is used with the Admittance Meter and the TYPE 874-LK Constant-Impedance Adjustable Line, the Admittance Meter will read balanced impedance directly. When the 874-UB-P3 300-ohm Terminal Pad is used, the 50-ohm coaxial output from a signal generator such as the TYPE 1021-A can be converted into a 300-ohm balanced output, or a 50-ohm coaxial load (or detector) can be converted into a 300-ohm load to provide a matched termination to a 300-ohm line.

**DESCRIPTION:** The balun makes the balanced-to-unbalanced conversion accurately by using a tunable artificial (or loaded) half-wave line. It is adjusted for proper operation at a particular frequency by means of shunt tuning elements, such as the TYPE 874-D20 Adjustable Stub, the TYPE 874-VC Variable Capacitor, and the various fixed-length air lines. The tuning elements required for various frequency ranges are indicated in a table below. These elements are not supplied with the TYPE 874-UB Balun but should be obtained separately to cover the desired frequency range.

A TYPE 874-WN3 Short-Circuit Termination and a TYPE 874-WO3 Open-Circuit Termination are supplied with the balun. These terminations are necessary for proper adjustment of the Balun tuning. A terminal unit is also supplied for use in measuring the impedance and the standing-wave ratio of balanced lines and systems having a characteristic impedance of 300 ohms.

**SPECIFICATIONS**

**Frequency Range:** 54 to 1000 Mc with proper accessories as listed below.

**Accessories Supplied:** One TYPE 874-UB-P1 300-Ω Terminal; one TYPE 874-WN3 Short-Circuit Termination; one TYPE 874-WO3 Open-Circuit Termination.

**Other Accessories Recommended:** One TYPE 874-LK Constant-Impedance Adjustable Line (for use with the TYPE 1602-B Admittance Meter), one TYPE 874-Z Stand, tuning elements as listed below, and the accessories on the next page that are appropriate to the particular measurement desired.

**Tuning Elements Required for Various Frequency Ranges**

<i>Frequency Range</i>	<i>Accessory Equipment</i>
470 to 1000 Mc	2-TYPE 874-D20 Adjustable Stubs
350 to 525 Mc	2-TYPE 874-D20 Adjustable Stubs and 2-TYPE 874-L10 Air Lines
275 to 380 Mc	2-TYPE 874-D20 Adjustable Stubs and 2-TYPE 874-L20 Air Lines
225 to 280 Mc	2-TYPE 874-D20 Adjustable Stubs and 2-TYPE 874-L30 Air Lines
170 to 280 Mc	2-TYPE 874-D50 Adjustable Stubs and 2-TYPE 874-L30 Air Lines
174 to 216 Mc	2-TYPE 874-VC Variable Capacitors and 2-TYPE 874-L10 Air Lines
140 to 174 Mc	2-TYPE 874-VC Variable Capacitors and 2-TYPE 874-L20 Air Lines
88 to 140 Mc	2-TYPE 874-VC Variable Capacitors and 2-TYPE 874-L30 Air Lines
54 to 88 Mc	2-TYPE 874-VC Variable Capacitors and 2-TYPE 874-XL Series Inductors

<i>Type</i>	<i>Code Word</i>	<i>Price</i>
874-UB <b>Balun</b> .....	COAXYBALUN	<b>\$75.00</b>
874-D20 <b>Adjustable Stub (20 cm.)</b> .....	COAXTUBBER	<b>14.00</b>
874-D50 <b>Adjustable Stub (50 cm.)</b> .....	COAXBIGGER	<b>14.00</b>
874-L10 <b>50-Ω Air Line (10 cm.)</b> .....	COAXDECKER	<b>5.50</b>
874-L20 <b>50-Ω Air Line (20 cm.)</b> .....	COAXVENTER	<b>6.00</b>
874-L30 <b>50-Ω Air Line (30 cm.)</b> .....	COAXTRIPLY	<b>6.50</b>
874-VC <b>Variable Capacitor</b> .....	COAXYFARAD	<b>42.50</b>
874-XL <b>Series Inductor</b> .....	COAXDUCTOR	<b>11.00</b>





BALUN ACCESSORIES

**Type 874-UB-P2 200-Ohm Terminal Unit**

This terminal unit connects the balun to a balanced network whose impedance is to be measured at its own terminals. The 4:1 impedance transformation that takes place in the balun converts the 200-ohm balanced line into a 50-ohm coaxial line, hence the 200-ohm balanced line can be treated as an extension of the 50-ohm line of the measuring device. If a TYPE 874-LK Constant-Impedance Adjustable Line is used to adjust the effective combined lengths of the 50-ohm and 200-ohm lines to a multiple of one-half wavelength, the measuring device is, in effect, connected at the terminals of the network under test. The 200-ohm line, RG-86/U, is suitable for this purpose, and this terminal unit is designed to connect to it.

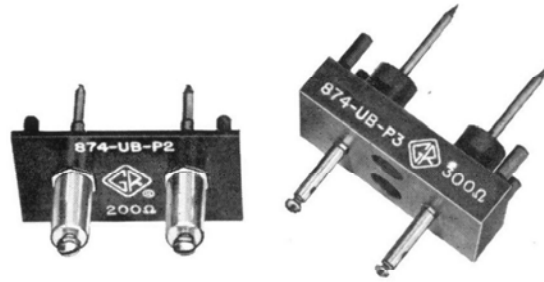

**SPECIFICATIONS**

**Characteristic Impedance:** 200 ohms.  
**Frequency Range:** d-c to 1000 Mc.  
**Recommended Transmission Line:** RG-86/U.  
**Net Weight:** 1 ounce.

Type	Code Word	Price
874-UB-P2   Balun Terminal Unit (200 ohms).....	COAXTERMER	\$6.50

**Type 874-UB-P3 300-Ohm Balun Terminal Pad**

This pad converts to 300 ohms the 200-ohm balanced output impedance produced from a 50-ohm unbalanced source by the balun. Conversely, the same arrangement can be used to terminate a 300-ohm balanced line in 300 ohms if the coaxial connector on the balun is connected to a matched TYPE 874-WM 50-Ohm Termination Unit or to a matched detector.

This pad facilitates power and voltage measurements on balanced systems, with signal generators, detectors, etc., designed for use with 50-ohm coaxial circuits. Measurements of the attenuation of balanced lines and the sensitivity and gain of receivers with 300-ohm balanced inputs are typical applications.

The unit consists of a built-in 50-ohm resistor in series with each balanced lead. This terminal pad is not recommended for use in impedance measurements. The TYPE 874-UB-P1 300-Ohm Terminal Unit, which is supplied with the balun, is used for this application.

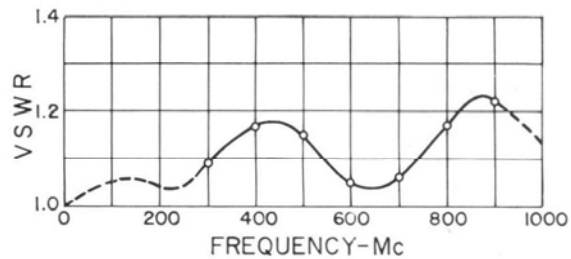

Plot of the VSWR at the 300-ohm terminals of a typical TYPE 874-UB-P3 Terminal Pad as a function of frequency when the pad is inserted in a properly adjusted balun whose coaxial circuit is terminated in 50 ohms.

**SPECIFICATIONS**

**Frequency Range:** d-c to 1000 Mc.  
**Input or Output VSWR:** Where coaxial line is terminated in 50 ohms, VSWR at 300-ohm balanced terminals is less than 1.2 up to 300 Mc, and less than 1.3 up to 1000 Mc.  
**Net Weight:** 2 ounces.

Type	Code Word	Price
874-UB-P3   300-Ohm Balun Terminal Pad....	COAXTUGGER	\$13.00

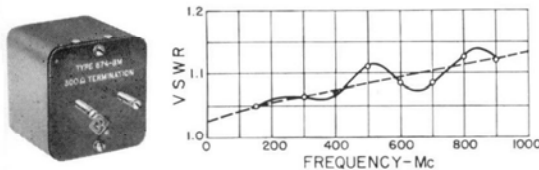

A plot of the VSWR as a function of frequency of a typical TYPE 874-BM 300-Ohm Balanced Termination Unit.

**Type 874-BM 300-Ohm Balanced Termination**

A useful element to facilitate balanced line measurements.  
**D-C Resistance:** 300 ohms  $\pm 5\%$   
**Frequency Range:** 0-1000 Mc

Type	Code Word	Net Weight	Price
874-BM	COAXLOADER	1½ ounces	\$5.00



LINES AND LINE ELEMENTS

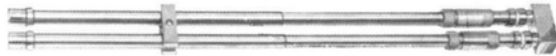

**Type 874-LT Trombone Constant-Impedance Line**

With this line stretcher, built like a trombone slide, the length of a 50-ohm transmission line between two fixed terminals can be varied without moving either terminal or using flexible cable. Consists of two 874-LK's mounted parallel to one another and joined at one end by a U-shaped section to form a rigid assembly. Can be

plugged into two adjacent TYPE 874 Coaxial Connectors or inserted in a line by means of two ells (not included). This saves space when line is used vertically. Low VSWR.

**Characteristic Impedance:** 50 ohms.  
**Frequency Range:** D-C to 2000 Mc.  
**Adjustment Range:** 44 cm (half wave at 340 Mc).  
**Physical Length:** 61 cm (min.) to 83 cm. (max.)  
**Spacing:** 1 3/16 inches between centers.  
**VSWR:** Less than 1.10 to 1000 Mc, and 1.25 to 2000 Mc.

Type	Code Word	Price
874-LT   Constant-Impedance Line	COAXTROMBO	\$85.00



**Type 874-LK Constant-Impedance Adjustable Lines**

A line stretcher with a very low VSWR and a uniform characteristic impedance of 50 ohms. A locking mechanism is provided for maintaining desired adjustments. In impedance measurements, this line stretcher is particularly useful for eliminating the usual Smith-chart corrections for the length of line between the unknown and the impedance-measuring device. This is accomplished by adjusting the overall line length to a multiple

of one-half wavelength. Admittance measuring devices, such as the TYPE 1602-B Admittance Meter, can be made to read directly in impedance by adjustment of the overall line length to an odd multiple of a quarter wavelength. This line is also useful as an impedance-matching transformer in coaxial systems.

**Impedance:** 50 ohms.  
**Length:** TYPE 874-LK20 Adjustable from 58 to 80 cm. (half-wave at 680 Mc); TYPE 874-LK10, Adjustable from 35 to 45 cm (half-wave at 1500 Mc).  
**VSWR:** TYPE 874-LK20 Less than 1.03 at 560 Mc, 1.06 at 1000 Mc, 1.08 at 1500 Mc, and 1.10 at 2000 Mc.; TYPE 874-LK10, same up to 2000 Mc, less than 1.15 at 3000 Mc, 1.2 at 4000 Mc, 1.25 at 5000 Mc.  
**Net Weight:** 874-LK20 14 ounces; 874-LK10, 10 ounces.

Type	Code Word	Price
874-LK20   Constant-Impedance Adjustable Line (22 cm)	COAXKEEPER	\$36.00
874-LK10   Constant-Impedance Adjustable Line (10 cm)	COAXKENTER	33.00



**Type 874-LA Adjustable Line (Line-stretcher)**

An air-dielectric, coaxial line that can be telescoped to change its length. Used in matching networks. Contacts are made by multiple spring fingers.

**Characteristic Impedance:** Not constant — approximately 50 ohms when fully collapsed. Approximately 57 ohms when fully extended.

**Length:** From 33 to 58 cm.  
**Net Weight:** 10 ounces.

Type	Code Word	Price
874-LA   Adjustable Line	COAXLAPPER	\$17.50



**50-Ohm Air Lines**

For spacing stubs or other elements of a coaxial system. Each air line consists of a length of 50-ohm, air-

dielectric, coaxial line with a TYPE 874 Coaxial Connector at each end.

Type	Net Weight	Code Word	Price
874-L10   10 cm	2 oz.	COAXDECKER	\$5.50
874-L20   20 cm	4 oz.	COAXVENTER	6.00
874-L30   30 cm	6 oz.	COAXTRIPLY	6.50

**Type 874-T Tee**

Used for connecting stubs and other elements in shunt with a coaxial line. **Net Weight:** 3 ounces.

Type	Code Word	Price
874-T   Tee	COAXTOGGER	\$8.50



TYPE 874-EL



TYPE 874-T



TYPE 874-JR

**Type 874-EI 90° Ell**

For making a right-angle bend in a coaxial system. **Characteristic Impedance:** 50 ohms. **Electrical Length:** Approximately 7 cm. **VSWR:** Less than 1.06 at 2000 Mc; less than 1.15 at 4000 Mc. **Net Weight:** 3 ounces.

Type	Code Word	Price
874-EL   90° ELL	COAXANGLER	\$6.50

**Type 874-JR Rotary Joint**

Used when one part of a system must be rotated with respect to another part, as when measuring antenna patterns or where changing the coupling of a loop. **VSWR:** Less than 1.05 at 1000 Mc; less than 1.3 at 4000 Mc.

Type	Code Word	Price
874-JR   Rotary Joint	COAXJOINER	\$9.00



TERMINATIONS

Type 874-WM 50-ohm Termination

A 50-ohm cylindrical resistor mounted in a tapered coaxial holder, for impedance matching, establishing reference conditions, terminating filters and attenuators.

**D-C Resistance:** 50 ohms  $\pm 1\%$   
**Max. Continuous Power:** 1/2 watt  
**Max. Peak Power:** 500 watts

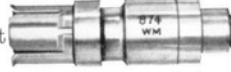

Type	Code Word	Net Weight	Price
874-WM	COAXMEETER	2 1/2 ounces	\$12.50

Type 874-WN Short-Circuit Termination

A fixed shorting strap mounted in a connector, for establishing reference conditions on coaxial lines and for use in substitution measurements.

Type 874-WN3 Short-Circuit Termination

(See photograph, page 59)

Same as TYPE 874-WN except the short circuit is presented at a point exactly 3 cm (3.2 cm. electrical distance) beyond the face of the bead in the TYPE 874 Connectors. This distance corresponds to the distance between the bead and ground plane of the 874-M Component Mount and the distance between the head and the unbalanced terminal in the TYPE 874-UB Balun.

Type	Code Word	Net Weight	Price
874-WN	COAXNULLER	2 ounces	\$2.50
874-WN3	COAXYTRINU	2 ounces	\$3.75

Type 874-WO Open-Circuit Termination

A shielding cap for open-circuited lines, for establishing reference condition on coaxial lines and for use in substitution methods. Produces an open circuit at same point in line that TYPE 874-WN produces a short.

Type 874-WO3 Open-Circuit Termination

(See photograph, page 59)

Same as Type 874-WO except for position of open circuit, which is same as for TYPE 874-WN3 above.

Type	Code Word	Net Weight	Price
874-WO	COAXOPENER	2 ounces	\$1.75
874-WO3	COAXYTRIPO	2 ounces	\$2.50

Type 874-W100 100-ohm Coaxial Standard

Produces known resistive termination at specific locations on coaxial lines for checking detector linearity, accuracy of directional couplers, bridges and admittance meters. The known location of the pure resistive termination makes possible the production of many known complex impedances through additions of sections of TYPE 874-L Air Line.

**D-C Resistance:** 100 ohms  $\pm 1\%$   
**Max. Continuous Power:** 1/3 watt  
**Max. Peak Power:** 150 watts



Type 874-W200 200-Ohm Coaxial Standard

Same as above except 200 ohm termination.  
**D-C Resistance:** 200 ohms  $\pm 1\%$   
**Max. Continuous Power:** 1/4 watt  
**Max. Peak Power:** 50 watts

Type	Code Word	Net Weight	Price
874-W100	COAXCENTER	3 ounces	\$17.50
874-W200	COAXFILTER	3 ounces	\$17.50

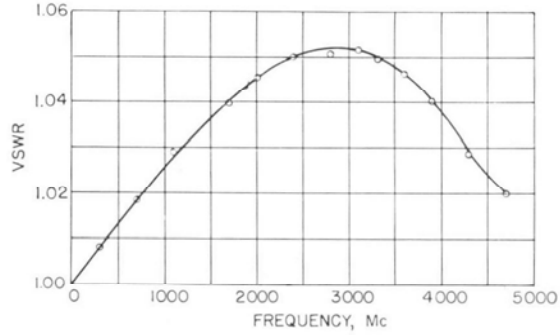

Standing-wave ratio of a typical TYPE 874-WM 50-ohm Termination as a function of frequency.

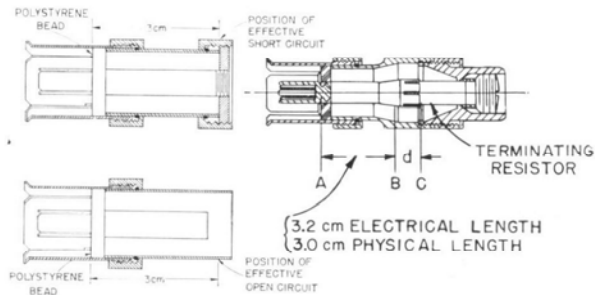

Cross section of Type 874-WN3 (left, top) TYPE 874-WO3 (left, bottom) and TYPE 874-W100 (right).

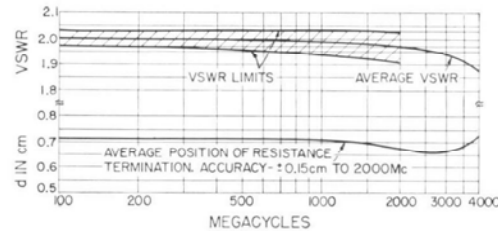

Plot of the VSWR and position of the pure resistance termination, for a TYPE 874-W100 100-Ohm Coaxial Standard. The distance, d, (see cross section above) is the distance from the position of the short or open circuit produced by a TYPE WN3 or WO3 Termination Unit to the position of the pure resistance termination. The cross-lined area indicates the tolerances on the characteristics.

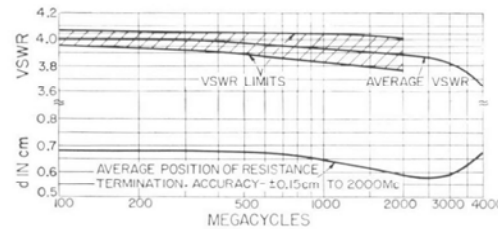

Plot of the characteristics of a TYPE 874-W200 200-Ohm Coaxial Standard.



STUBS AND TUNING ELEMENTS

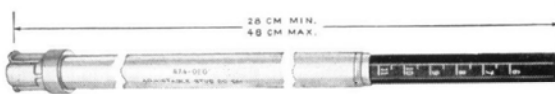

Type 874-D20 and D50 Adjustable Stubs

For matching or tuning, and use as reactive elements. Can be used with indicator and scale as reaction-type

wavemeters. Stub consists of a coaxial line with a sliding short circuit of the multiple spring-finger type. The 20-cm stub is calibrated in stub electrical length from the junction of the branch line with the through line in a TYPE 874-T. The 50-cm stub has no calibration but has an adjustable reference marker.

Characteristic Impedance: 50 ohms  
Maximum Travel of Short Circuit: 20 cm for 874-D20  
50 cm for 874-D50

Type		Net Weight	Code Word	Price
874-D20	Adjustable Stub (20 cm).....	6 oz.	COAXTUBBER	\$14.00
874-D50	Adjustable Stub (50 cm).....	10 oz.	COAXBIGGER	14.00

Type 874-VC Variable Capacitor



General-purpose tuning element in resonant-line circuits, matching transformers, and baluns at low frequencies where the size of line-type elements makes them awkward to use. It consists of a well-shielded TYPE 1420 Variable Air Capacitor with high-temperature polystyrene insulation and precision ball bearings.

Dial Calibration: 0-100 (Not calibrated in  $\mu\text{mf}$ )  
Capacitance Variation: Linear  
Size: 2 1/2" diameter x 5 1/4" high  
Capacitance Range: High frequencies, see curve; Low frequencies, 14 to 70  $\mu\text{mf}$  at connector, 16.5 to 72.5  $\mu\text{mf}$  at T-junction.  
Net Weight: 12 ounces

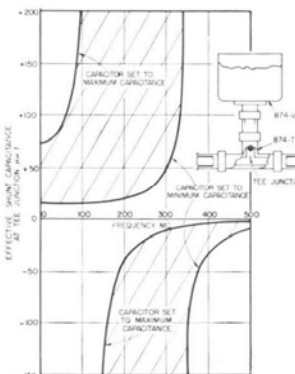

Type	Code Word	Price
874-VC   Variable Capacitor. . .	COAXYFARAD	\$42.50

Type 874-XL Series Inductor

Used as a general-purpose tuning element in resonant-line circuits, matching transformers, and baluns at low frequencies, the series inductor is a solenoid mounted in a TYPE 874-X Insertion Unit (see page 59).  
Series Inductance: 0.226  $\mu\text{h}$   $\pm 5\%$  at 1 kc.

Type	Code Word	Price
874-XL   Series Inductor. . . . .	COAXDUCTOR	\$11.00

COUPLERS

Type 874-LR Radiating Line



Allows coupling an external wavemeter or heterodyne frequency meter to the fields within a coaxial system. Consists of short coaxial line with opening in outer conductor that can be partially or completely covered by a rotatable sleeve.  
VSWR: Closed, less than 1.05 at 1000 Mc, less than 1.4 at 3000 Mc, and less than 1.2 at 4000 Mc; open, less than 1.12 at 1000 Mc, less than 1.6 at 3000 Mc, and less than 1.35 at 4000 Mc.  
Net Weight: 4 ounces.

Type 874-MA Adjustable Coupling Loop

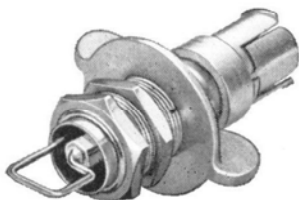

A general-purpose coupling loop. Consists of short coaxial line with a one-turn loop at one end and a TYPE 874 Coaxial connector at the other. A collet is supplied for panel mounting. The loop can be adjusted for desired degree of coupling and clamped in that position by the collet.  
Physical Length Over-all: 3 inches.  
Maximum Diameter: 1 7/8 inches.  
Net Weight: 3 ounces.

Type 874-MB Coupling Probe

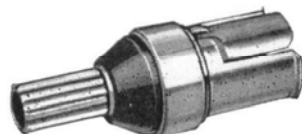

A general-purpose electrostatic probe consisting of a binding post mounted on a TYPE 874 Coaxial connector.  
Physical Length Over-all: 2 1/8 inches.  
Net Weight: 3 ounces.

Type		Code Word	Price
874-LR	Radiating Line.....	COAXMITTER	\$8.50
874-MA	Adjustable Coupling Loop.....	COAXLOOPER	5.50
874-MB	Coupling Probe.....	COAXPROBER	3.25



## ATTENUATORS

## Type 874-GA Adjustable Attenuator

A mutual-inductance (waveguide-below-cutoff) type of attenuator, useful for producing known voltage ratios, for measuring attenuation, and for adjusting voltage magnitude. Consists of a loop that can be positioned longitudinally within a hollow tube by rotating an outside sleeve. One turn of the sleeve produces a 20-db change in attenuation. Sleeve and tube are calibrated directly in decibels of relative attenuation on a micrometer-type scale. The absolute attenuation is the sum of the insertion loss and the reading of the attenuator. The input system is a short coaxial line with a connector at each end, one end for connection to the power source and the other for connection to a 50-ohm termination, an adjustable stub, or any desired load. The output of the loop is brought out through three feet of double-shielded 50-ohm flexible cable, which is approximately matched at the loop end by a 50-ohm resistor between the low side of the loop and ground.

Can be used in conjunction with TYPE 874-VR Voltmeter Rectifier and TYPE 874-VI Voltmeter Indicator to convert a GR Unit Oscillator into a signal generator. **Calibrated Range:** 120 db (relative attenuation); usable range depends upon shielding between input and output.

**Insertion Loss:** (from input connector to end of output cable at 1000 Mc, when signal source impedance is 50 ohms)

With input line terminated in 50 ohms, Minimum (scale set at -9 db, i.e., end of travel), -18 ± 2 db

At beginning of accurately calibrated range (attenuator set at 0 db), -33 ± 2 db

With input line terminated in adjustable stub, (to produce voltage minimum under coupling loop), Minimum (attenuator set at -9 db), -20 ± 2 db

At beginning of accurately calibrated range (attenuator set at -9 db), -20 ± 2 db. Insertion loss is approximately inversely proportional to frequency up to 1000 Mc.

**Insertion Loss Directly Through Tee:** Negligible

**Accuracy of Attenuation:**

Stub-terminated input, ±(1% of difference in attenuation readings +0.2) db, direct reading.

50-ohm terminated input, ±(1½% of difference in

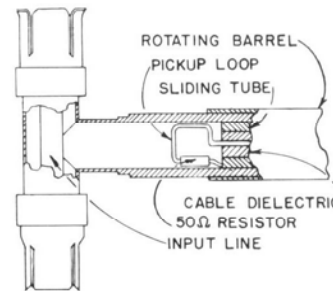
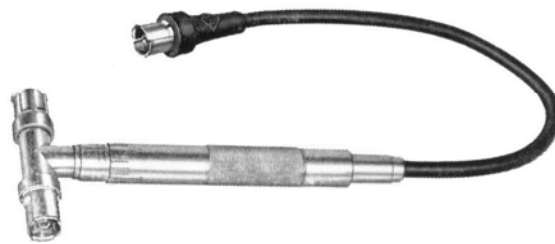

Cross section of the coupling system used in the TYPE 874-GA Adjustable Attenuator.

attenuation readings +0.2) db, when corrected. Correction chart supplied.

**Waveguide Mode:** TE<sub>1,1</sub>; cutoff frequency: 12,300 Mc.

**VSWR Introduced into Line:** Less than 1.03 at 1000 Mc.; less than 1.2 between 1000 and 4000 Mc.

**VSWR of Output:** Less than 4 at 1000 Mc.

Less than 5 up to 4000 Mc.

**Maximum Power:** Input power is inversely proportional to frequency and should not exceed 150 watts at 1000 Mc; output power should not exceed ½ watt.

**Frequency Range:** 100 Mc to 1000 Mc.

**Net Weight:** 1¼ pounds.

Type	Code Word	Price
874-GA	Adjustable Attenuator	COAXLOSSER   \$55.00

## Fixed Attenuators

A single section, T-type resistance pad. Useful for matching generators or loads to 50 ohms, over the frequency range from dc to several thousand megacycles. Consists of one disk resistor and two cylindrical resistors, as shunt and series elements respectively.

**Impedance:** 50 ohms ±1%

**VSWR:** less than 1.1 to 1000 Mc; 1.30 to 4000 Mc for 874-G20, 1.35 to 4000 Mc for all other attenuators.

**Accuracy of Attenuation in 50-ohm System:** ±1.5% of nominal attenuation at dc; ±0.2 db from value indicated on curve to 1000 Mc; ±0.4 db to 2000 Mc; ±0.6 db to 4000 Mc.

**Temperature Coefficient:** less than 0.0003 db/°C/db

**Maximum Continuous Power Input:** 1 watt

**Maximum Peak Power Input:** 3000 watts

**Physical Length:** 3½ inches overall

**Net Weight:** 2 ounces

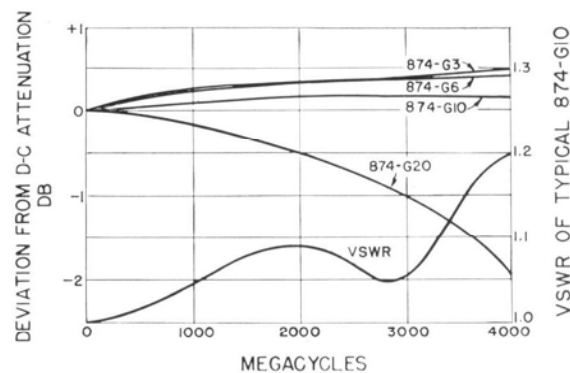

Type	Code Word	Price
874-G3	Fixed Attenuator (3 db)	COAXFULLER   \$25.00
874-G6	Fixed Attenuator (6 db)	COAXNODDER   25.00
874-G10	Fixed Attenuator (10 db)	COAXBELLER   25.00
874-G20	Fixed Attenuator (20 db)	COAXNEPPER   25.00



FILTERS



Type 874-F Low-Pass Filters

Reduction of harmonics from an u-h-f generator by filters such as these is usually necessary for best measurement results, particularly if a system contains peak-reading voltmeters, non-linear elements, or sections that might resonate at a harmonic frequency, or if high standing-wave ratios are to be measured using a slotted line. These filters are of the Tschebyscheff type, in which very sharp cutoff is obtained at some sacrifice of uniformity in the pass band. The alternately large- and small-diameter sections of the inner conductor form the equivalent of shunt capacitances and series inductances respectively. Unequal section lengths reduce the likelihood of spurious pass bands above cutoff.

Accuracy of Cut-off Frequencies: -0%, +10%.

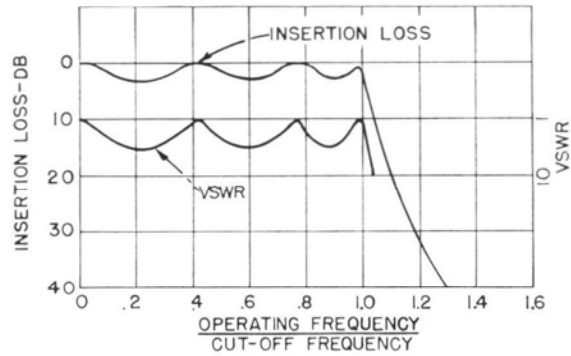

Insertion Loss and VSWR of the TYPE 874-F Low-pass Filters.

Type	Net Weight, Ounces	Physical Length, Inches	Code Word	Price
874-F185	185 Mc Low Pass Filter	14	17 <sup>5</sup> / <sub>16</sub>	COAXRUFFER \$24.50
874-F500	500 Mc Low Pass Filter	8	10 <sup>3</sup> / <sub>16</sub>	COAXDIPPER 16.00
874-F1000	1000 Mc Low Pass Filter	6	7 <sup>1</sup> / <sub>8</sub>	COAXMEGGER 14.00
874-F2000	2000 Mc Low Pass Filter	5	4 <sup>3</sup> / <sub>8</sub>	COAXPUSHER 14.00
874-F4000	4000 Mc Low Pass Filter	4	2 <sup>7</sup> / <sub>8</sub>	COAXLENDER 14.00



Type 874-FRI, -FR2, -FR3 Rejection Filters

These rejection filters are specifically intended for use with other General Radio equipment in the measurement of harmonics of VHF television transmitters in accordance with FCC specifications. A booklet describing the measurement procedure is available on request. Each filter consists of a simple, series-resonant L-C circuit in shunt with a short section of 50-ohm coaxial line. The capacitor is adjustable (screwdriver setting) to vary the resonant frequency, and the three filters offered have different values of inductance to cover the different frequency ranges. A pair of units must be used for

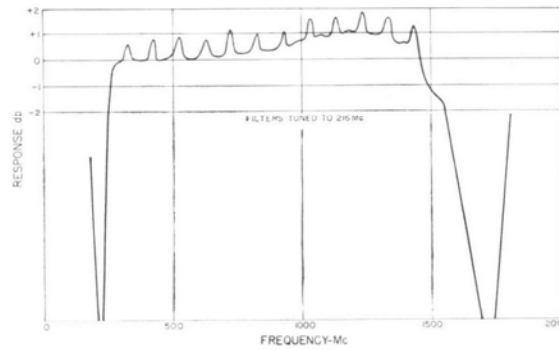

Response curve of a pair of TYPE 874-FR3 Rejection Filters with the TYPE 874-MR Mixer Rectifier.

TV transmitter harmonic measurement, hence they are priced in pairs in the table below:

Type	For TV Channel	Fund. Rej. of Pair	Tuning Range	Upper Freq. Limit of Flat Pass Band	Code Word	Price
874-FR1	2, 3, 4	60 db	54-90 Mc	740 Mc	COAXROUTER	\$70.00/pair
874-FR2	5, 6	60 db	76-135 Mc	900 Mc	COAXRINGER	70.00/pair
874-FR3	7 thru 13	60 db	130-216 Mc	1300 Mc	COAXROCKER	70.00/pair

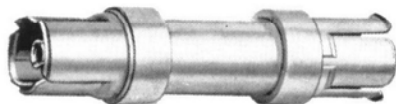

Type 874-K Coupling Capacitor

Consists of a short length of coaxial line having a cylindrical capacitor in series with the inner conductor. High frequencies are transmitted with small reflections,

but dc and low audio frequencies are blocked. This unit is often necessary for separating d-c paths in systems including two or more crystal rectifiers, as in measurements of insertion loss.

Coupling Capacitance: 5000  $\mu\mu\text{f}$  -20% +50%  
 VSWR: Less than 1.06 at 1000 Mc; 1.2 at 2000 Mc.  
 Length: 3<sup>5</sup>/<sub>16</sub> inches  
 Net Weight: 3 ounces

Type	Code Word	Price
874-K   Coupling Capacitor	COAXKICKER	\$8.50



MISCELLANEOUS

**Type 874-M Component Mount**

The TYPE 874-M Component Mount is a shielded enclosure with convenient inside terminals for mounting small components to be measured. It minimizes "lead" reactance and stray capacitance when the impedance of circuit elements and networks is measured over a frequency range from d-c to 5000 Mc.

The Component Mount connects directly to the TYPE 874-LBA Slotted Line, the TYPE 1602-B Admittance Meter, the TYPE 874-LK Constant-Impedance Adjustable Line, and all GR Coaxial Elements.

The Short- and Open-Circuit Terminations supplied simplify determination of line-length corrections between the instrument measuring point and the component being measured, without disconnection of the component from the Mount.

**SPECIFICATIONS**

**Frequency Range:** D-c to 5000 Mc.

**Accessories Supplied:** One TYPE 874-WN3 Short-Circuit Termination, one TYPE 874-WO3 Open-Circuit Termination.

**Other Accessories Recommended:** One TYPE 874-LK20 Constant-Impedance Adjustable Line when the Mount is used with the TYPE 1602-B Admittance Meter.

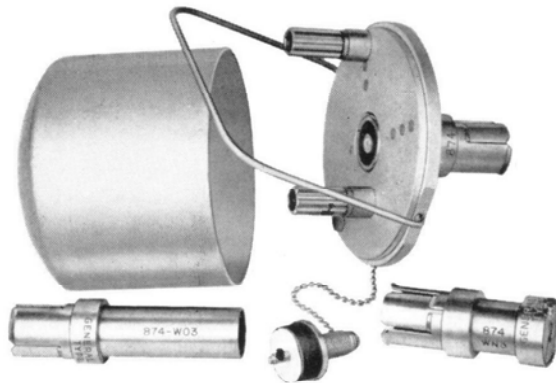

**Dimensions:** Diameter, 3 inches. Height of shield can, 2<sup>5</sup>/<sub>8</sub> inches.

**Terminal:** TYPE 874 Coaxial Connector.

**Net Weight:** 8 ounces.

Type	Code Word	Price
874-M   Component Mount . . .	COAXYMOUNT	\$25.00

**Type 874-X Insertion Unit**

This unit is a hollow cylinder fitted with TYPE 874 Connectors at each end. Its cover sleeve slides back to allow access to a region inside of about 2 inches in length and 9/16 inch in diameter. In this space between the TYPE 874 Connectors, almost any arbitrary arrangement of small components, such as resistors, capacitors, or inductors, can be mounted. The insertion unit can be used as a shielded housing for impedance-matching networks, attenuator pads, VHF transformers, filters, and a variety of other networks. It offers good shielding, minimum discontinuity in the line, and convenience.

**Net Weight:** 4 ounces.



Type	Code Word	Price
874-X   Insertion Unit . . . . .	COAXHOPPER	\$8.25

**Type 874-Y Cliplock**

A negator spring which can be conveniently slipped over TYPE 874 Connectors after they are engaged. It provides a secure lock preventing accidental disconnection or slippage.

**Net Weight for 10:** 1 ounce.

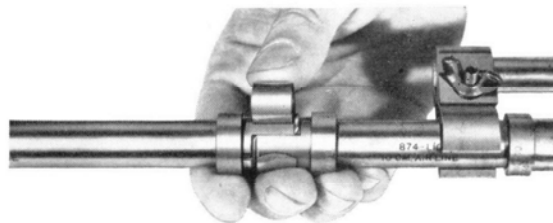

Type	Code Word	Price
874-Y   Cliplock . . . . .	COAXLOCKER	10* for \$2.00

\* Minimum quantity sold.

**Type 874-Z Stand**

Provides firm support for the parts of a wide variety of coaxial systems. Consists of a heavy cast-iron base with rubber feet, 22-inch and 8-inch stainless steel rods, and three universal clamps. The vertical rod can be used to hold long tuning stubs. The horizontal rod can be moved longitudinally or interchanged with the vertical rod to provide support where needed. Two bases can be used with one 22-inch rod between them to support a long horizontal run of coaxial parts. Clamps will fit a range of diameters and will hold between two rods of different diameters. Any desired arrangement can be set up quickly. Base can be screwed down to table top for permanent setups.

**Net Weight:** 5<sup>1</sup>/<sub>2</sub> pounds.

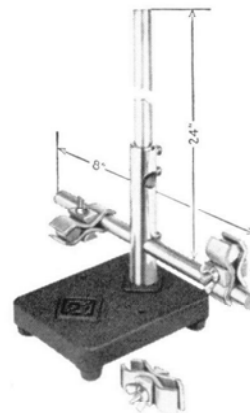

Type	Code Word	Price
874-Z   Stand . . . . .	COAXHELPER	\$15.00
874-ZC   Extra Clamp . . . . .	COAXYCLAMP	2.25



CABLE

Type	Description	Code Word	Price
874-A2	<p><b>COAXIAL CABLE</b> Flexible double shielded bulk cable for permanent or semi-permanent installations and for making long patch cords. Consists of a No. 14 stranded inner conductor separated from the two braided tinned-copper shield by 0.214" O.D. polyethylene insulation, and an outer polyvinyl-chloride jacket 0.365" O.D. <b>Characteristic Impedance:</b> 50 ohms <math>\pm 5\%</math>. <b>Nominal Capacitance:</b> 32 <math>\mu\text{mf}</math> per foot. <b>Attenuation:</b> at 100 Mc about 2.6 db per 100 feet; at 1000 Mc about 10.5 db per 100 feet. <b>Net Weight</b> for 25 feet: 2<math>\frac{3}{4}</math> pounds.</p>	COAXCUTTER	<p><b>\$0.50/foot</b> <b>0.27/foot*</b></p> <p>*In lengths of 25 feet or more.</p>
874-A3	<p><b>COAXIAL CABLE</b> Same as above except inner conductor is 19 strands of 0.0066 inch turned soft copper wire, separated from the two, braided shields by 0.116" O.D. polyethylene insulation, and an outer polyvinyl chloride jacket 0.206" O.D. <b>Characteristic Impedance:</b> 50 ohms <math>\pm 5\%</math>. <b>Attenuation:</b> at 100 Mc about 5.3 db per 100 feet; at 1000 Mc about 22.0 db per 100 feet; at 3000 Mc about 45.0 db per 100 feet. <b>Net Weight</b> for 25 feet: 1 pound.</p>	COAXGABBER	<p><b>\$0.35/foot</b> <b>0.20/foot*</b></p> <p>*In lengths of 25 feet or more.</p>
874-R20	<p><b>FLEXIBLE LINE (PATCH CORD)</b> For making shielded connections where minimum loss is desired. Consists of three feet of 874-A2 Polyethylene Cable (specifications above) with a TYPE 874-C Connector on each end. <b>Net Weight:</b> 7 ounces.</p>	COAXHATTER	<b>\$6.50</b>
874-R21	<p><b>PATCH CORD</b> Consists of three feet of flexible, single-shielded coaxial cable with a nominal characteristic impedance of 50 ohms. It is terminated on both ends by TYPE 874-C58 Coaxial Connectors. <b>Net Weight:</b> 4 ounces.</p>	COAXHUNTER	<b>\$6.50</b>
874-R22	<p><b>PATCH CORD</b> Consists of three feet of 874-A3 Coaxial Cable (specifications above) with a TYPE 874-C58 Cable Connector on each end. Recommended for use where both maximum shielding and a high degree of flexibility are needed. <b>Net Weight:</b> 4 ounces.</p>	COAXFANNER	<b>\$6.00</b>
874-R32A	<p><b>PATCH CORD</b> Consists of three feet of flexible, single-shielded coaxial cable with a nominal characteristic impedance of 50 ohms. It has one end terminated in a TYPE 274-ND Shielded Double Plug and the other in a TYPE 874-C58 Coaxial Connector. <b>Net Weight:</b> 4 ounces.</p>	COAXFITTER	<b>\$5.50</b>



TYPE 874-A2 or -A3



TYPE 874-R20



TYPE 274NF  
(see page 242)



TYPE 874-R21 or -R22



TYPE 874-R32A





CONNECTORS

All TYPE 874 Connectors are supplied unassembled with complete assembly instructions. No special tools are needed.

**Type 874-B Basic Connector**

For use on rigid, 50-ohm, air-dielectric, coaxial lines. Consists of inner and outer conductors, insulating bead coupling nut and retaining ring. Fits lines made from  $\frac{5}{8}$ -inch O.D.,  $\frac{3}{16}$ -inch I.D. tubing, and 0.244-inch D rod. The inner conductor is to be screwed into an 8-32 tapped hole in the end of the rod, and the retaining ring for the coupling nut is to be snapped into a  $\frac{1}{64}$ -inch deep, 0.035-inch-wide groove cut in the  $\frac{5}{8}$ -inch tubing.

Net Weight: 1 ounce.

Type	Code Word	Price
874-B   Basic Connector.....	COAXBRIDGE	\$1.15

**Cable Connector**

Consists of the basic connector parts plus inner and outer transition pieces, a soft copper ferrule, and a rubber guard. The transition pieces are tapered so as to maintain the 50-ohm characteristic impedance of the connector and cable throughout the change in diameters. The cable inner conductor is to be soldered to the inner transition piece, and the cable braid is attached to the outer transition piece by crimping the ferrule. The rubber guard provides strain relief and a protective handle.

Net Weight: 2 ounces.

Type	Fits	Code Word	Price
874-C	Type 874-A2 Cable.....	COAXCABLER	\$1.70
874-C8	Type RG-8/U Cable.....	COAXCORDER	1.70
874-C9	Type RG-9/U and RG-116/U Cables.....	COAXCAMMER	1.70
874-C58	Type 874-A3, RG-29/U, 55/U, 58/U, and 58A/U Cables.....	COAXCALLER	1.70
874-C62	Types RG-59/U and RG-62/U Cables (non-constant impedance).....	COAXCANDOR	1.70

**Panel Connector P-Type**

Is similar to the cable connector except a panel adaptor and nut are supplied in place of rubber guard. The panel adaptor fits into a  $\frac{15}{16}$ -inch D hole in panels from  $\frac{1}{16}$ -inch to  $\frac{1}{4}$ -inch thick and is designed to clamp the connector in any desired orientation.

Net Weight: 3 ounces.

Type	Fits	Code Word	Price
874-P	Type 874-A2 Cable.....	COAXPEGGER	\$2.75
874-P8	Type RG-8/U Cable.....	COAXPUTTER	2.75
874-P9	Types RG-9/U and RG-116/U Cables.....	COAXCOPPER	2.75
874-P58	Types 874-A3, RG-29/U, 55/U, and 58A/U Cables.....	COAXPANNER	2.75
874-P62	Types RG-59/U and RG-62/U Cables (non-constant impedance).....	COAXPOLLER	2.75



TYPE 874-B Basic Connector

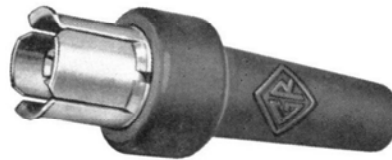

TYPE 874 Cable Connectors

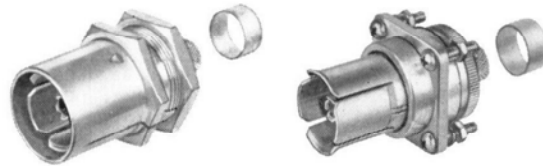

TYPE 874-P

TYPE 874-PB

Panel Connectors

**Panel Connector PB-Type**

Flange-mounted panel connector. Requires a  $\frac{15}{16}$ -inch D hole in panel of any thickness. Four number 29 holes (0.136-inch D) drilled in flange,  $\frac{13}{16}$ -inch center-to-center, to accept machine screws. Panel space required is  $1\frac{1}{16}$ -inch x  $1\frac{1}{16}$ -inch.

Net Weight: 2 ounces.

Type	Fits	Code Word	Price
874-PB	Type 874-A2 Cable.....	COAXAPPLER	\$2.75
874-PB8	Type RG-8/U Cable.....	COAXBATHER	2.75
874-PB9	Types RG-9/U and RG-116/U Cables.....	COAXCANKER	2.75
874-PB58	Types 874-A3, R6-29/U, 55/U, 58/U and 58A/U Cables.....	COAXBATER	2.75
874-PB62	Types RG-59/U and RG-62/U Cables (non-constant impedance).....	COAXBARKER	2.75

Cut-away view of basic connector joined with cable connector.

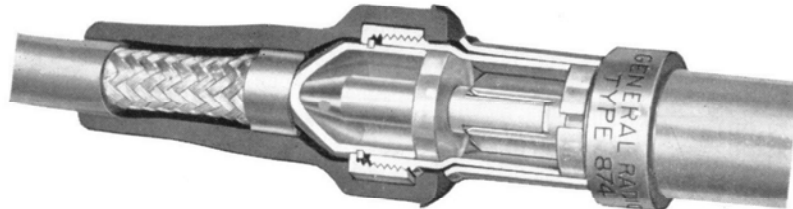



ADAPTORS

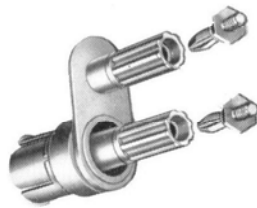

TYPE 874-Q2  
Fits both plugs and jacks

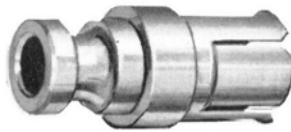

TYPE 874-Q6

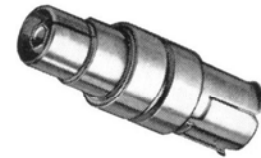

TYPE 874-Q7  
Fits both plugs and jacks



TYPES 874-QBJ and -QBP



TYPES 874-QCJ and -QCP



TYPES 874-QHJ and -QHP

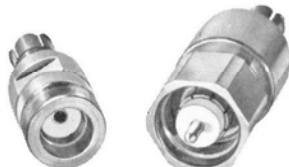

TYPES 874-QLJ and -QLP



TYPES 874-QNP and -QNJ

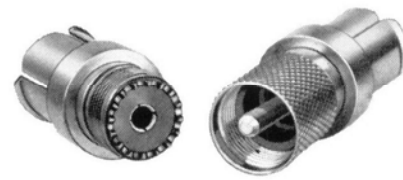

TYPES 874-QUJ and -QUP

These adaptors enable the user to connect the Type 874 Coaxial elements and instruments fitted with Type 874 Connectors to other common systems of connectors.

Type	Contains Type 874 Connector and Fits	Fits	Net Weight	Code Word	Price
874-Q2	274 Jacks	274 Plugs	2 oz.	COAXTIPPER	\$4.00
874-Q6	Pin & Sleeve	274-NF	1 oz.	COAXCLOSER	2.25
874-Q7	774 Jack	774 Plug	2 oz.	COAXPASSER	3.75
874-QBJ	BNC Jack	BNC Plug	1 1/2 oz.	COAXBIGGER	4.75
874-QBP	BNC Plug	BNC Jack	1 1/2 oz.	COAXBUNNER	4.75
874-QCJ	C Jack	C Plug	1 oz.	COAXCOGGER	4.75
874-QCP	C Plug	C Jack	1 3/4 oz.	COAXCUFFER	6.25
874-QHJ	HN Jack	HN Plug	2 1/2 oz.	COAXHAWSER	6.50
874-QHP	HN Plug	HN Jack	2 1/2 oz.	COAXHANGER	6.50
874-QLJ	LC Jack	LC Plug	8 oz.	COAXLITTER	17.50
874-QLP	LC Plug	LC Jack	1 lb.	COAXLUGGER	27.00
874-QNJ	N Jack	N Plug	1 3/4 oz.	COAXNAGGER	3.75
874-QNP	N Plug	N Jack	1 3/4 oz.	COAXNUTTER	4.50
874-QUJ	UHF Jack	UHF Plug	1 oz.	COAXYUNDER	4.00
874-QUP	UHF Plug	UHF Jack	1 1/2 oz.	COAXYUPPER	4.25

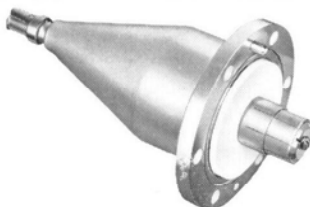
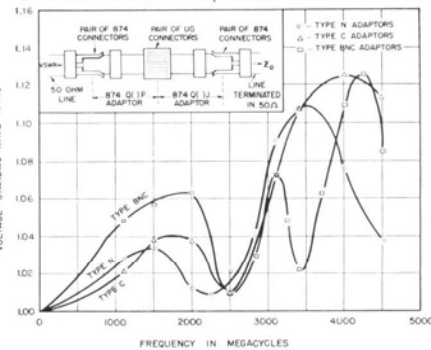

TYPE 874-QU3A

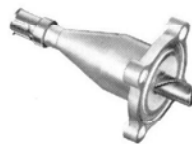

TYPE 874-QV2A

These adaptors are used to connect the rigid lines in TV transmitting antenna systems to measuring equipment fitted with Type 874 Coaxial Connectors, as the TYPE 1602-B U-H-F Admittance Meter and the TYPE 874-LBA Slotted Line.

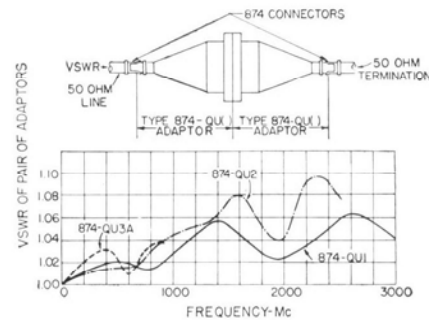

Type	Fits	RETMA Std. for Line	Code Word	Net Weight	Price
874-QU1	7/8" 50-ohm UHF Rigid Line, RG-155/U..	TR-134	COAXYUMBER	1/2 lb.	\$21.00
874-QU2	1 1/8" 50-ohm UHF Rigid Line, RG-153/U..	TR-134	COAXYUSHER	1 1/4 lb.	75.00
874-QU3A	3/8" 50-ohm UHF Rigid Line, RG-154/U..	TR-134	COAXYULTRA	5 1/4 lb.	125.00
874-QV2A	1 1/8" 51.5-ohm VHF Rigid Line.....	TR-103A	COAXYVERRA	1 1/4 lb.	62.50
874-QV3	3/8" 51.5-ohm VHF Rigid Line.....	TR-103A	COAXYWAGER	5 lb.	110.00

# DETECTORS

In practically all types of electrical measurements, a means must be provided for aural or visual indication of the desired measurement condition. For bridge measurements, the indicator, or detector, must have some degree of selectivity to eliminate spurious signals, noise, and harmonics of the desired signal. For voltage amplitude measurements, a wide linear range is desirable; in frequency measurements, a high degree of selectivity is usually necessary for accurate measurements; and in modulation measurements, the output signal should be a faithful reproduction of the modulation envelope.

For these applications, a number of detectors are in common use:

1. Amplifier followed by a meter or headphones.
2. Simple rectifier to convert an a-c signal to dc or to demodulate an r-f signal.
3. Simple rectifier followed by a high-gain amplifier with an aural or visual indicator.
4. Mixer in which the signal to be measured is heterodyned with a signal of a different frequency from an oscillator and the difference frequency amplified in a fixed-frequency, high-gain amplifier.

An amplifier with meter or headphones is commonly used in the frequency range between a few cycles and several megacycles. The *Type 1231-B Amplifier and Null Detector* is an instrument of this type, for audio and somewhat higher frequencies. Selectivity can be added by the use of a filter, either the highly astatic TYPE 1951-A, or one of the TYPE 1231-P series of filters.

When used with the TYPE 1231-P4 Attenuator, the amplifier is a good standing-wave meter for the TYPE 874-LBA Slotted Line.

The *Type 1212-A Unit Null Detector* is another detector of the same general type, which covers a much wider frequency range and uses limiting amplifiers to produce a non-linear compression of the meter scale of at least 100 db, thus eliminating the need for amplifier gain adjustments during bridge balancing operations.

For maximum effective sensitivity, one of the several accessory filters should be used at the input: the TYPE 1212-P1, for eliminating pickup at the power-line frequency in measurements above 10 kc; the TYPE 1951-A,

Sensitivity and frequency range of various detectors. The sensitivity figures shown for the TYPE 874-VQ and -VR Detectors are for a modulated signal (50% or more) with the amplifier tuned to the modulator frequency. At frequencies below about 500 kc an additional by-pass capacitor must be added to obtain the sensitivity indicated.

for maximum effective sensitivity and selectivity at 400 and 1000 cycles; and the TYPE 1212-P2, for maximum sensitivity and selectivity at 1 megacycle.

Simple rectifiers are often used at the higher frequencies. The *Type 874-VQ Voltmeter Detector* and *Type 874-VR Voltmeter Rectifier* cover a very wide frequency range, as indicated on the chart. When used directly with a meter or a telephone headset, the sensitivity is low. When a modulated signal is being detected, and the rectifier is followed by a high-gain amplifier such as the TYPE 1231-B, higher sensitivity, suitable for standing-wave measurements on a slotted line, can be obtained.

At these high frequencies, the heterodyne method of detection has many advantages. It can have high sensitivity, a wide frequency range, any amount of selectivity, and excellent linearity. In the *Type DNT Detectors*, the signal is heterodyned in a TYPE 874-MR Mixer Rectifier with a signal from a Unit Oscillator. The 30-Mc beat frequency is amplified and detected by a TYPE 1216-A Unit I-F Amplifier. Various local oscillators can be used to cover the very extensive frequency range shown in the chart, and harmonic operation can be used to extend the range of any oscillator. The 80-db linear range is also useful in relative voltage-level measurement.

Type	Class	See Page
1231-B	High-gain Voltage Amplifier	64
1212-A	Logarithmic Amplifier	66
1216-A	Heterodyne with I-F Amplifier	68
874 VQ,-VR	Crystal Rectifier	49

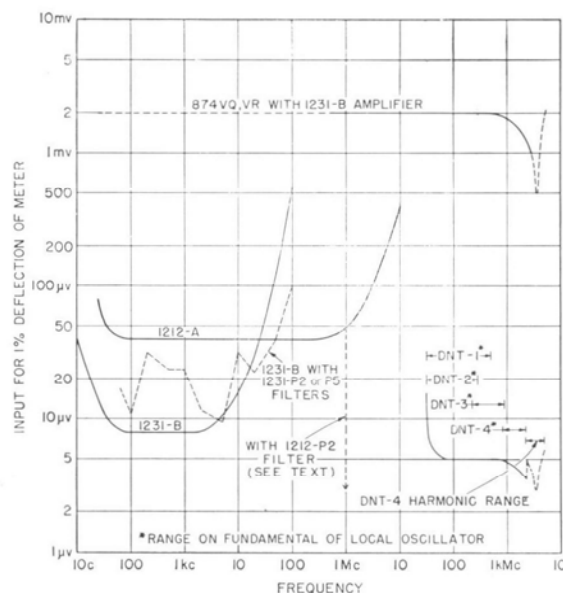



## TYPE 1231-B AMPLIFIER AND NULL DETECTOR

**USES:** A high-gain amplifier for general laboratory use, the TYPE 1231-B is also used as a sensitive null indicator for bridge measurements and as a standing-wave indicator for measurements with the TYPE 874-LBA Slotted Line. Used with a suitable crystal detector, it will indicate amplitude-modulated high-frequency voltages. It is also used as a preamplifier for crystal microphones, vibration pickups and oscilloscopes.

**DESCRIPTION:** A push button on the panel of the instrument permits the output stage of the amplifier to operate either linearly for general use or logarithmically for null-detector use. The panel meter indicates relative output in two ranges, serves as a null indicator, and is used to check battery condition. Head telephones may be plugged in the amplifier for an aural indication of the null point. A fixed 30 db attenuator may be switched into the input circuit if high input voltages are encountered. The instrument may be ac or battery operated. Battery operation provides better overall performance, due mainly to its lower noise. Blocking capacitors at the input and output jacks isolate the instrument from



external dc. A filter jack on the panel permits insertion of filters, such as the various TYPE 1231-P models, for modifying the frequency characteristic of the amplifier.

- FEATURES:**
- Simple and convenient push-button operation.
  - Versatile — Operates as amplifier, null indicator or VSWR meter.
  - Rapid response meter with minimum overshoot for fast, accurate measurements.
  - Harmonics and noise can be eliminated by available filters.

### SPECIFICATIONS

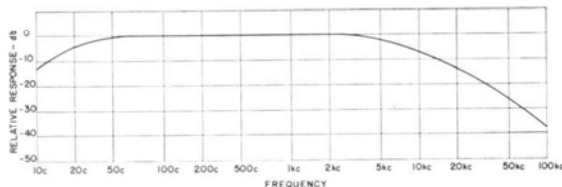

**Input Impedance:** 1 megohm in parallel with 20  $\mu$ f; alternate 10-megohm input available.

**Maximum Gain:** Greater than 83 db at 1 kc with 1 megohm load.

**Meter Scales:** NORM scale: monitors amplifier output voltage. Calibrated in volts with accuracy of  $\pm 5\%$  of full scale. SENS scale: indicates ratios of voltages applied to input terminals, as in standing-wave measurements. Calibrated in db with arbitrary zero, so ratio in db obtained by subtracting one meter reading from another. Ratios accurate within 30% of correct value in db, if one reading is above half scale.

**Null Detector Sensitivity:** Less than 25 microvolts input gives 1% indication on meter at 1 kc.

**Amplifier Sensitivity:** Less than 8 microvolts input at 1 kc for 1% indication on SENS range of meter.

**Output Impedance:** Approximately 50,000 ohms.

**Maximum Output Voltage:** 5 volts into 20,000 ohms; 20 volts into one megohm.

**Open Circuit Noise and Hum Level:** Less than 0.5 volt at full gain, battery operated; less than one volt, a-c operated with 1261-A Power Supply.

**Tube Complement:** Two 1L4, one 1D8-GT.

**Power Supply:** Burgess 6TA60 (Signal Corps BA48) is supplied unless a-c operation is specified, in which case Type 1261-A Power Supply (see page 147) is supplied.

**Battery Life:** 200 to 250 hours at 8 hours a day.

**Mounting:** Available for 19-inch relay rack with or without Type 1213-P5 Filters, battery or a-c operated, or in walnut cabinet. See price list below.

**Accessories Available:** Filters, Types 1231-P2, 1231-P3, and 1231-P5 on next page; for eliminating strong 60-cycle pickup, TYPE 1951-A, page 67. For shielded input and output, TYPE 274 NEO Patch Cords recommended.

**Dimensions:** 12 $\frac{1}{4}$  x 8 x 10 $\frac{3}{4}$  inches, over-all.  
**Net Weight:** 23 $\frac{3}{4}$  pounds, including batteries (cabinet model).

Type	Amplifier and Null Detector	Code Word	Price
1231-BM	Cabinet model, battery operated.....	VALID	\$250.00
1231-BMA	Cabinet model, a-c operated.....	VENUS	378.00
1231-BR	Relay-rack model, battery operated.....	VALOR	250.00
1231-BRA	Relay-rack model, a-c operated.....	VIGIL	378.00
1231-BRF	Relay-rack model, battery operated, with Type 1231-P5 Filter.....	VIGOR	450.00
1231-BRFA	Relay-rack model, a-c operated, with Type 1231-P5 Filter.....	VILLA	578.00



Parallel-tuned circuits used as interstage filters with the TYPE 1231-B for suppressing harmonics, noise, and hum in single frequency measurements. The filters are supplied with a telephone plug that plugs into a jack on the panel of the TYPE 1231-B.

**Tuning Accuracy:**  $\pm 2\%$  at normal voltage levels.  
**Attenuation:** At least 25 db to second harmonic.  
**Dimensions:**  $4\frac{1}{8}$  (height) x  $3\frac{9}{16}$  (width) x 4 (depth) inches overall.  
**Net Weight:**  $3\frac{7}{8}$  pounds, either model.

### TYPES 1231-P2 AND P3

TUNED  
CIRCUITS



Type	Frequency	Code Word	Price
1231-P2	400 and 1000 cycles.....	AMBLE	\$30.00
1231-P3	60 cycles.....	AMPLE	25.00

### TYPE 1231-P5

ADJUSTABLE  
FILTER

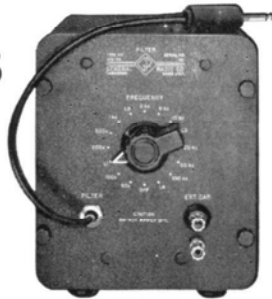

This parallel-resonant, shielded filter is used with amplifiers to reduce harmonics and background noise in bridge measurements. It can be set to any one of eleven fixed frequencies, including those at which the TYPE 716-C Ca-

pacitance Bridge is direct reading. Terminals are provided for connecting an external capacitor to tune to any other frequency between 20 c and 100 kc.

**Frequency Calibration:** 50, 100, 200, 500 c; 1, 2, 5, 10, 20, 50, 100 kc.  $\pm 2\%$  at normal voltages.  
**Insertion Gain:** -7 to +15 db, depending upon frequency. Second Harmonic Rejection: 28 to 46 db.  
**Terminals:** Shielded cord and plug for connection to TYPE 1231. Jack-top terminals for external capacitors.  
**Accessories Available:** TYPE 219 Decade Capacitors (page 160) for tuning filter between frequencies provided.  
**Mounting:** Aluminum cabinet model for bench use and relay-rack model available.  
**Dimensions:** Front panel, 7 (height) x  $6\frac{1}{8}$  (width) inches. Cabinet,  $9\frac{3}{4}$  (depth) inches. Internal shield box,  $6\frac{1}{4}$  (height) x  $4\frac{1}{2}$  (width) x 9 (depth) inches.  
**Net Weight:** 9 pounds, 12 ounces.

Type	Code Word	Price
1231-P5M Adjustable Filter (Cabinet Model).....	ALDER	\$215.00
1231-P5R Adjustable Filter (Relay-Rack Model).....	ADOBE	215.00

### TYPE 1231-P4 ADJUSTABLE ATTENUATOR

The TYPE 1231-P4 Adjustable Attenuator is a high-impedance resistive voltage divider covering a range of 80 db, with three 20 db steps and a 20 db potentiometer.

When it is used with the TYPE 1231-B Amplifier and Null Detector and the TYPE 874-LBA Slotted Line to measure standing-wave ratio, both the range and accuracy of measurement are increased over what can be obtained with the amplifier alone.

**Source Impedance:** 30 k $\Omega$ , about equal to output impedance of crystal detector in slotted line.  
**Load Impedance:** At least one megohm.  
**Insertion Loss:** 3 db  
**Attenuation Range:** 80 db, readable to nearest tenth db.  
**Attenuation Accuracy:**  $\pm 0.3$  db when operated between rated source and load impedances. Additional errors caused by source impedance between 14 k $\Omega$  and 60 k $\Omega$  are less than  $\pm 0.3$  db.

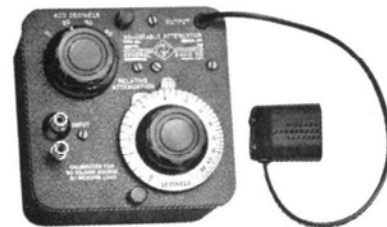

**Frequency Error:** Negligible below 2 kc.  
**Maximum Input Power:**  $\frac{1}{2}$  watt  
**Terminals:** Input, TYPE 938-W Binding Posts; Output, shielded cable with TYPE 274-ND Shielded Plug to fit amplifier input terminals.  
**Accessories Required:** One TYPE 874-R32A Patch Cord for connections between slotted line and attenuator.  
**Dimensions:**  $5\frac{1}{2}$  x  $5\frac{1}{2}$  x  $4\frac{1}{2}$  inches, over-all.  
**Net Weight:** 2 pounds, 11 ounces.

Type	Code Word	Price
1231-P4 Adjustable Attenuator.....	ANNEX	\$70.00
874-R32A Patch Cord.....	COAXFITTER	5.50



## TYPE 1212-A UNIT NULL DETECTOR

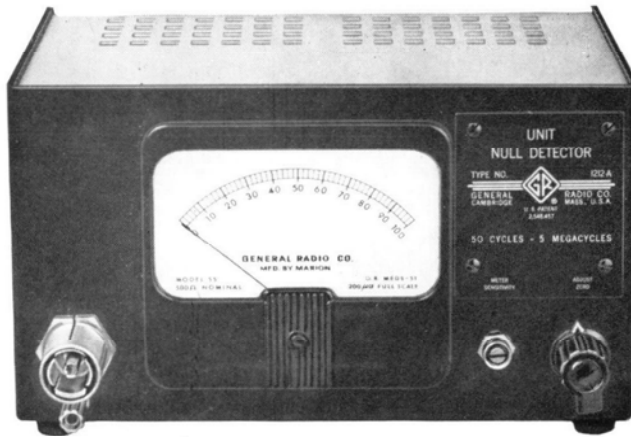

**USES:** The Unit Null Detector is primarily a balance indicator for a-c bridge measurements. It is a sensitive, wide-frequency-range voltage indicator with an approximately logarithmic relation between input voltage and meter reading. This null detector with suitable input filters can be used with the TYPE 716-C Capacitance Bridge, TYPE 667-A Inductance Bridge, TYPE 561-D Vacuum Tube Bridge, TYPE 916-AL R-F Bridge, and up to 5 Mc with the TYPE 1606-A R-F Bridge and the TYPE 821-A Twin-T Impedance-Measuring Circuit.

**DESCRIPTION:** The instrument consists of a three-stage, broad-band amplifier with series-peaking compensation. Germanium-diode clippers are used between stages to obtain the quasi-logarithmic input-output relationship.

- FEATURES:**
- 20 cycles to 5 megacycles.
  - Meter zero controllable from panel to correct for amplifier or system noise.
  - Regulated tube voltages and balanced meter circuit maintain high stability.
  - Meter sensitivity control provided for settings of voltage range desired.
  - Headphones can be used.
  - Miniaturized unit construction.
  - On-Scale range of approximately 120 db.
  - High sensitivity.
  - Sensitivity increases as balance is approached — increases speed and precision.
  - High bridge generator voltage can be used, improving balance sensitivity and signal-to-noise ratio.

### SPECIFICATIONS

**Sensitivity:** Less than 40 microvolts input at 1 kc is required to deflect meter one per cent of full scale.  
**Voltage Response:** See curve below.  
**Power Supply:** TYPE 1203-A or Type 1201-A Unit Power Supply is recommended.

**Frequency Response:** See curve below.  
**Tube Complement:** Three 6AK5, one 12AX7, one 0A2.  
**Accessories Supplied:** Power Supply plug and cable connector.

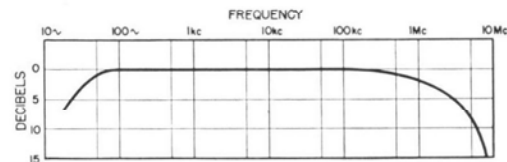
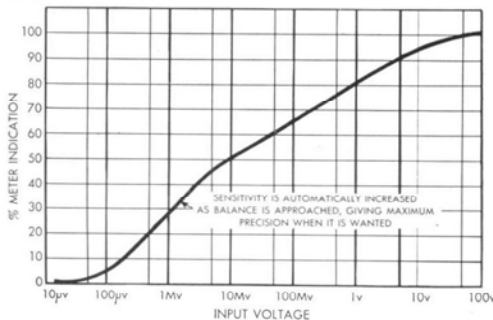

**Accessory Filters Available:** TYPES 1212-P1, for eliminating low-frequency hum and noise, 1212-P2, for use at 1 Mc, 1951-A, for maximum sensitivity and selectivity at 400 and 1000 cycles.  
**Dimensions:** (Width) 9½ x (height) 5¾ x (depth) 6 inches, over-all.  
**Net Weight:** 5½ pounds.

Type		Code Word	Price
1212-A	Unit Null Detector	ALACK	\$145.00
1203-A	Unit Power Supply	ALIVE	40.00

PATENT NOTICE. See Note 4, page viii.



### TYPE 1212-P1 HIGH-PASS FILTER

The TYPE 1212-P1 Filter is a shielded, R-C high-pass filter designed to attenuate low-frequency noise and hum often encountered in bridge measurements. It provides about 50 db attenuation at 60 cycles when used in conjunction with the TYPE 1212-A Unit Null Detector and fed from a low-impedance source. It can be used effectively over a reasonably wide range of input and output impedances. It is housed in a TYPE 874-X Insertion Unit equipped with TYPE 874 Coaxial Connectors on both ends.

(The TYPE 1212-P1 High-Pass Filter is shown with the TYPE 1212-A Unit Null Detector in the photograph on the facing page.)

- Attenuation Characteristics:** See curve.
- Nominal Load Impedance:** 1 megohm.
- Input Voltage Limit:** 150 volts maximum.
- Terminals:** TYPE 874 Connector at each end.
- Dimensions:** 7/8 inch diameter by 4 3/8 inches long.
- Net Weight:** 3 ounces.

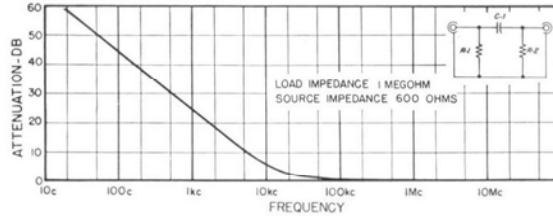

Type	Code Word	Price
<b>1212-P1</b>   High-Pass Filter . . . . .	UNCLE	<b>\$12.00</b>

PATENT NOTICE. See Note 4, page viii.

This device is a shielded, tuned L-C filter designed to attenuate both higher and lower frequencies, while providing insertion gain at 1 megacycle when used with the TYPE 1212-A Unit Null Detector. This combination is used with the TYPE 716-CS1 Capacitance Bridge (page 20) to measure the capacitance of small capacitors and the dissipation factor of low-loss dielectrics at 1 Mc.

**Insertion Gain:** When used with the TYPE 716-CS1 Capacitance Bridge and the TYPE 1212-A Unit Null Detector, the insertion gain at 1 Mc varies from 22 db when measuring 100  $\mu\text{f}$  capacitors to 32 db with 1000  $\mu\text{f}$ .

### TYPE 1212-P2 1-MC FILTER



- Second Harmonic Rejection:** At least 39 db.
- Maximum Input Voltage:** 200 volts.
- Terminals:** TYPE 874 Connector at each end.
- Dimensions:** 2" diameter, 5" long.
- Weight:** 9 ounces.

Type	Code Word	Price
<b>1212-P2</b>   One-Megacycle Filter . . . . .	ANNUL	<b>\$30.00</b>

### TYPE 1951-A FILTER

The TYPE 1951-A Filter is a tuned circuit designed for use at the input to a high-gain amplifier to prevent overload by spurious signal pickup. It is particularly useful for measurements on three-terminal circuits where both sides of the unknown are above ground.

Wound on a toroid and shielded with permalloy, this filter is highly astatic and can be used as the input of an amplifier of microvolt sensitivity without trouble from pickup. A capacitive voltage divider across the input permits impedance matching for maximum sensitivity.

- Frequency:** 400 cycles and 1000 cycles.
- Maximum Allowable R-M-S Input Voltage:** Depends on input impedance range. At 400 c from 4 to 165 v. At 1000 c from 10 to 200 v.
- Second Harmonic Rejection:** At least 30 db.



- Insertion Gain:** -15 db to +35 db depending on driving source resistance and frequency.
- Accessories Supplied:** One each TYPE 274-MB Double Plug, TYPE 274-ND Shielded Plug, TYPE 874-Q6 Adaptor.
- Dimensions:** 3 1/8 x 3 1/4 x 4 3/8 inches, over-all.
- Net Weight:** 1 3/4 pounds.

Type	Code Word	Price
<b>1951-A</b>   Filter . . . . .	FIBRE	<b>\$75.00</b>



## TYPE 1216-A UNIT I-F AMPLIFIER

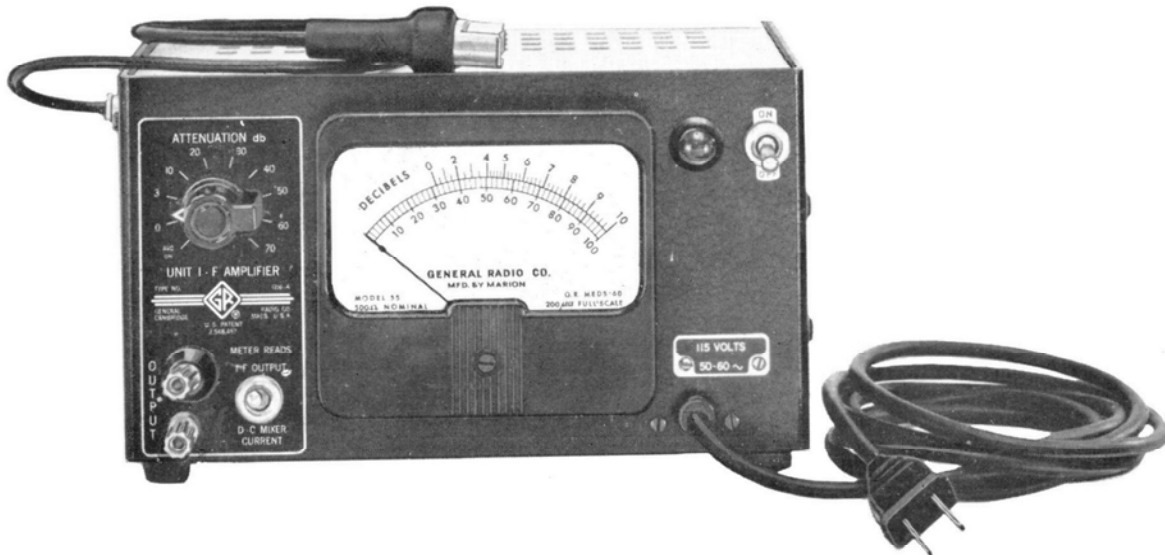

**USES:** The Unit I-F Amplifier is the basic element in the general-purpose, high-frequency TYPE DNT Detector Assemblies. The system is the recommended null detector for the TYPE 1602-B U-H-F Admittance Meter, and as a standing-wave indicator for use with the TYPE 874-LBA Slotted Line.

The high sensitivity and wide frequency range of the system make it useful as a general-purpose high-frequency receiver for laboratory use. The wide bandwidth of the amplifier makes possible the detection of pulsed signals. The built-in attenuator can be used for the accurate measurement of relative signal levels, the insertion loss and attenuation of filters, attenuators and cables at high frequencies, and crosstalk in coaxial switches.

**DESCRIPTION:** The Unit I-F Amplifier is a four-stage, high-gain, 30-Mc amplifier. When used in the TYPE DNT Detector Assembly, it amplifies a 30-Mc difference frequency produced by a mixer-rectifier from the original signal and a heterodyning local oscillator. The 30-Mc signal, which is proportional to the amplitude of the r-f signal, is amplified and indicated on a large meter that has both linear and db scales.

Any modulation on the signal is amplified by a cathode-follower amplifier having a 0.4 Mc bandwidth and is available at a pair of binding posts on the panel. Reasonably short pulses can, therefore, be passed by the amplifier.

The signal can be heterodyned with a harmonic of the oscillator as well as with the fundamental, with some decrease in sensitiv-

ity, and, as a result, the frequency range is much wider than that of the oscillator used.

Automatic volume control is provided for use in balancing bridges and other null-type devices.

A built-in, precision, film-type-resistor, step attenuator is included to make possible accurate measurements of relative signal levels as high as 70 db. The indicating meter is calibrated in db, as well as in linear units, for convenient interpolation between the 10-db attenuator steps.

The rectified crystal-mixer current produced by the oscillator signal in the TYPE 874-MR Mixer-Rectifier can be measured on the indicating meter. A knowledge of this current is important if attenuation measurements are to be made, since the oscillator voltage must be above a certain limit if the applied r-f signal is large. The current is also an indication that the oscillator is functioning.

Although this amplifier has been designed primarily for use with the mixer and oscillators previously mentioned, satisfactory operation can be obtained with other mixers and oscillators.

The assembly includes two a-c power supplies, one for operating the amplifier and a second for the Unit Oscillator producing the heterodyning signal.

- FEATURES:**
- Accurate attenuator.
  - Large meter calibrated linearly and in db for interpolation between attenuator steps.
  - High sensitivity with excellent shielding.
  - Broad bandwidth with good selectivity.
  - AVC provided for null detector use.





- Cathode follower amplifies modulation. Can be used with phones.
- Can check rectified local oscillator current.

- Provides power for external local oscillator.
- Small and compact assembly.
- Regulated screen voltage supply.

**SPECIFICATIONS**

**Center Frequency:** 30 Mc.  
**Bandwidth:** Greater than 0.5 Mc at 3 db down; 9.5 Mc at 60 db down.  
**Sensitivity:** From a 400-ohm source, 2  $\mu$ volts input required for 1% meter deflection (above noise), 50  $\mu$ volts input for full-scale meter deflection. These are open-circuit source voltages.  
**Attenuator Range:** 0-70 db in 10-db steps.  
**Attenuator Accuracy:**  $\pm(0.3 \text{ db} + 1\%)$ .  
**Output Circuit Bandwidth (modulation):** 0.4 Mc.  
**Output Impedance:** 600 ohms.  
**Maximum Output Voltage:** 2 volts open circuit.  
**Terminals:** Input, TYPE 874 Connector on 2-foot cable.  
**Output:**  $\frac{3}{4}$ -inch-spaced TYPE 938 Binding Posts.

**Supplementary Power Supply Output:** 300 volts dc at 40 ma; 6.3 volts ac at 1 a.  
**Power Supply:** 105-125 or 210-250 volts, 50 to 60 cycles. Power input, 45 watts at full load.  
**Tube Complement:** Two 6CB5; one each, 6AK5, 6AL5, 6U8, 0B2.  
**Accessories Supplied:** Spare fuses; multipoint connector; power cord attached.  
**Mounting:** Black-crackle finish aluminum panel and sides. Aluminum cover finished in clear lacquer.  
**Dimensions:** 5 $\frac{5}{8}$  (height) x 10 $\frac{1}{2}$  (width) x 6 $\frac{3}{8}$  (depth) inches, over-all.  
**Net Weight:** 8 $\frac{1}{4}$  pounds.

Type	Code Word	Price
<b>1216-A</b>   <b>Unit I-F Amplifier</b> .....	AMONG	<b>\$335.00</b>

PATENT NOTICE. See Note 4, page viii.

**TYPE DNT DETECTORS**



These assemblies are high-sensitivity, universal detectors for very high and ultra-high frequencies. They are not only excellent null detectors, but also are particularly useful in the measurement of gain and attenuation, relative signal level, and crosstalk, and in any measurement where a high-sensitivity laboratory receiver is needed.

All assemblies use one TYPE 874-MR Mixer Rectifier, one TYPE 1216-A Unit I-F Amplifier, one TYPE 874-G10 10-db pad, one TYPE 874-EL 90° Ell, one Unit Oscillator and one filter depending on frequency range desired (see price table). Higher-frequency operation

is obtainable by using oscillator harmonics. Both fundamental and harmonic ranges are shown in the curves below.

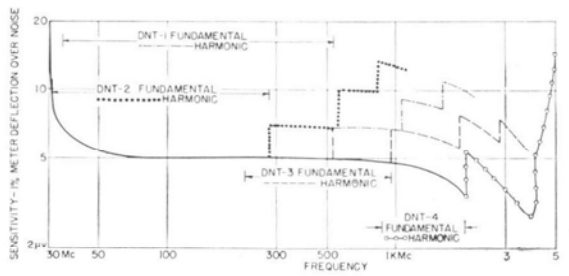

Type	Fundamental Frequency Range	Local Oscillator	Filter	Code Word	Price
<b>DNT-1</b>	35-530 Mc	1208-B	874-F500	NALTO	<b>\$615.00</b>
<b>DNT-2</b>	25-280 Mc	1215-B	874-F500	NERVO	<b>605.00</b>
<b>DNT-3</b>	220-950 Mc	1209-B	874-F1000	NULLO	<b>648.00</b>
<b>DNT-4</b>	870-2030	1218-A	874-F2000	NODDO	<b>894.00</b>

# FREQUENCY AND TIME

The determination of frequency directly in terms of time is a fundamental measurement, since frequency is the *time* rate of recurrence of a cyclical phenomenon. A *primary* standard of frequency is, therefore, defined as one whose frequency is determined directly in terms of time. A *secondary* standard is one whose frequency is determined by comparison with a primary standard, or by comparison with other secondary standards, some one of which was originally compared with a primary standard.

It is to be noted that the above classifications of frequency standards have nothing to do with the *accuracies* of the standards. In fact the same standard is logically classed as a primary standard if checked directly against time, and as a secondary standard if checked against standard frequency transmissions (representing a distant primary standard).

In practice, the responsibility of establishing and maintaining accurate time determinations by astronomical observations is not assumed by the individuals desiring a primary standard of frequency. The time determinations are carried out by observatories especially equipped for the purpose. The results are made available to a large number of users by radio and wire transmission. In the United States, the U. S. Naval Observatory trans-

mits high-precision time signals by radio through the facilities of the U. S. Naval Radio Service. Transmissions on a number of frequencies are available several times a day and can be received nearly all over the world. Standard time signals monitored by the Naval Observatory are also broadcast continuously by the standard-frequency transmitters of WWV, operated by the Bureau of Standards. A similar service is provided in Canada by the Dominion Observatory.

The user of a primary frequency standard can then conveniently determine the frequency of the standard in terms of the standard time interval sent to him by radio. In the General Radio equipment means are provided for quickly and easily making this comparison. For the most precise results, the errors of the transmitted time signal must be taken into account. Correction data may be obtained by applying to the Superintendent, U. S. Naval Observatory, Washington, D. C.

Since the astronomical clocks now used at the Naval Observatory are piezo-electric oscillators, similar to those used in accurate frequency standards, and since, through close cooperation of the U. S. Naval Observatory and the National Bureau of Standards, the piezo-electric oscillators of the latter's primary frequency standard are checked in the same way as the former's astronomical clocks, the comparison with time is, in effect, carried out by the observatory. The standard-frequency transmissions sent out by the Bureau of Standards consequently represent a primary standard of high precision available to all who can receive the transmissions. Where such transmissions can be received, it is generally more convenient and much quicker to make the comparison by frequency than by time. For information and schedules of transmission of standard frequencies, apply to the Radio Division, Bureau of Standards, Department of Commerce, Boulder, Colorado.

A calibration against transmitted radio frequencies yields a *pseudo-instantaneous* frequency value of the standard; while a calibration against transmitted time signals yields an *average* frequency value of the standard during the period between successive observations which, for precision, must be an interval of several hours.

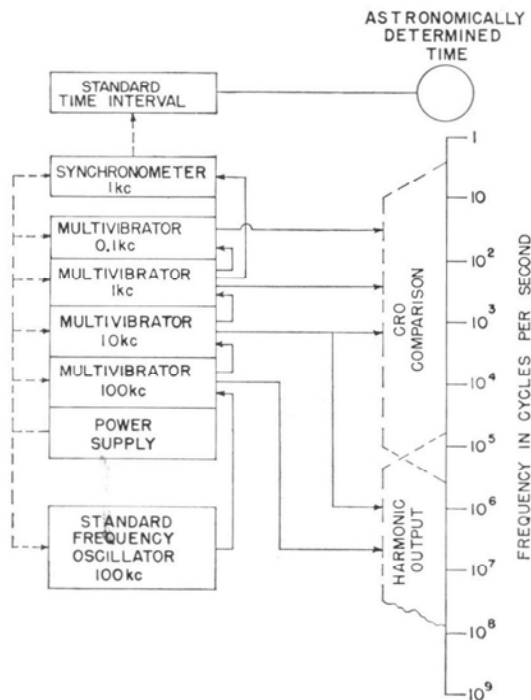

FIGURE 1. Block diagram showing the functional arrangement of the TYPE 1100-AP Primary Frequency Standard and the range of output frequencies available from it.



Because of the vagaries of high-frequency transmission, many users rely on checks against time as a reserve. They also use the primary standard as a high-precision clock for laboratory timing purposes.

As so far considered, the precision oscillator is a single-frequency device. For practical utility it is necessary to obtain from this single frequency many other frequencies, both above and below the standard frequency, for convenience in measurements. Since most of the precision oscillators operate in the region of 50 to 100 kc, it is necessary to divide the frequency to obtain a value such that a synchronous motor can be used to count the number of cycles executed by the precision oscillator in a standard interval of time. For measurements of high radio frequencies, it is necessary to multiply the standard frequency to obtain useful frequencies in the range of the frequency being measured. Both of these operations are readily performed by a controlled relaxation oscillator, known as a multi-vibrator.

#### THE PRIMARY FREQUENCY STANDARD TYPE 1100-AP

The elements of a primary frequency standard, General Radio TYPE 1100-AP, are shown in Figure 1.

The frequency of the precision oscillator is 100 kc, which is divided successively by factors of 10 to obtain multivibrator fundamental frequencies of 10, 1, and 0.1 kc. A fourth multivibrator, operating at a fundamental frequency of 100 kc, provides a large number of harmonics at 100-kc intervals for use at high radio frequencies. Harmonics of the 10-kc multivibrator are similarly used. In the audio-frequency and low-frequency range (up to one or two hundred kc) a cathode-ray oscilloscope is used to obtain hundreds of known frequencies. This is simpler than trying to make use of harmonics of the low standard frequencies.

FIGURE 2. View of the TYPE 1190-A Quartz Bar used in TYPE 1100-A Frequency Standard, with cover removed, showing the spring suspension.

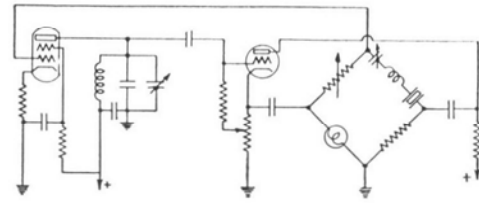
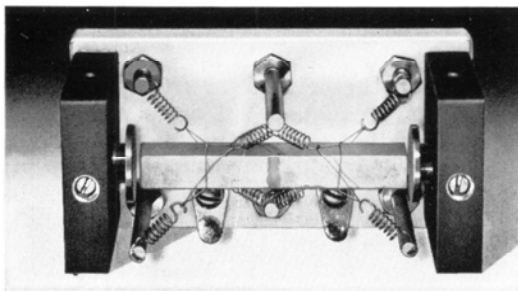

FIGURE 3. Elementary circuit of the bridge-type piezoelectric oscillator used in the TYPE 1100-A Frequency Standards.

The range of useful output frequencies obtainable from the General Radio Primary (or Secondary) Frequency Standard is indicated in Figure 1. Complete specifications are given on pages 74 to 76.

This frequency standard is the result of many years of continuous development in the General Radio laboratories. The quartz bar (and mounting), the oscillator circuit, and the temperature-control system used in the standard make possible a stability of a few parts in  $10^8$  over periods of several months, and a short-period stability of 0.5 part in  $10^8$  per day after one year's operation. The quartz bar and its mounting are shown in Figure 2. The bar vibrates in its second-harmonic extensional mode and is held at its two nodes in a spring suspension mounting in such a manner as to introduce a minimum of damping. Electrodes are formed directly on the surfaces of the quartz. The cross-sectional dimensions of the bar have been so chosen that the temperature coefficient of frequency is zero in the vicinity of the operating temperature of  $60^\circ\text{C}$ . The temperature-control system holds the temperature of the quartz bar constant to better than  $0.01^\circ\text{C}$ .

A bridge-type oscillator circuit is used, shown in schematic form in Figure 3. In this circuit, the crystal vibrates at its series-resonant frequency, and the amplitude of oscillation is constant.

#### THE SECONDARY FREQUENCY STANDARD TYPE 1100-AQ

In the past there was a useful field for frequency standards of less than the best possible precision, such standards being checked frequently against standard frequency transmissions. These standards could be manufactured at a lower cost than the more precise standards and consequently were used in many applications where price was a governing consideration.

At present the demand for more accurate secondary standards, coupled with less expensive designs for primary standards, makes it

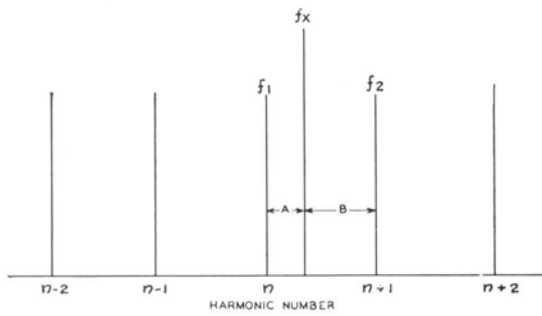

FIGURE 4. This diagram shows the relation between an unknown frequency and a standard harmonic series.

undesirable to make two types of standard. Consequently, the same component units are offered for use as a secondary standard — the precision oscillator, and multivibrator and power supply unit, but without the Synchronometer unit. (This latter unit can be added later, if desired.)

**THE UNIT TIME/FREQUENCY CALIBRATOR TYPE 1213-C**

For applications such as receiver or oscillator testing and calibration, band-edge checking, frequency and time-marker generation, the TYPE 1213-C Unit Time/Frequency Calibrator has been developed. It provides standard-frequency harmonics at multiples of 10 Mc, 1 Mc, 100 kc, and 10 kc, which extend above 1000 Mc, 500 Mc, 250 Mc, and 25 Mc respectively. Calibration of time intervals on oscilloscopes is possible using the output pulses provided at intervals of 0.1  $\mu$ s, 1.0  $\mu$ s, 10  $\mu$ s, and 100  $\mu$ s. The small size, low cost, and good stability of the calibrator make it useful where the high stability and precision of the primary or secondary standard of frequency is not necessary, or where the installation of such relatively elaborate equipment is not feasible. In addition, the availability of time markers for oscilloscopic measurements and a self-contained beat detector for oscillator calibration enables this instrument to solve many laboratory measurement problems formerly requiring several different items of measuring equipment. Complete specifications of the Unit Time/Frequency Calibrator are given on page 88.

**FREQUENCY MEASUREMENT**

The ultimate precision in the measurement of an unknown frequency requires establishment of a series of standard frequencies embracing that portion of the frequency spectrum in which the measurement is to be made, followed by an evaluation of the unknown frequency with reference to one of the stand-

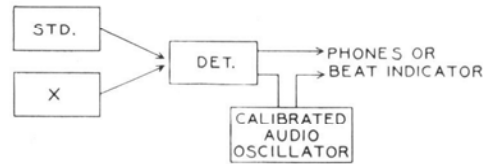

FIGURE 5. Functional diagram showing the operation of the direct-beating method of frequency measurement.

ard frequencies. Since any unknown frequency will lie between two of the standard frequency harmonics, as shown in Figure 4, the simplest process is to determine the difference in frequency between the unknown frequency and the nearest of the standard frequencies. This difference is added to the standard frequency if the unknown lies above the standard, or subtracted if the unknown lies below the standard frequency.

A convenient method of evaluating the frequency difference, A or B (Figure 4), consists of beating the standard and unknown frequencies in a detector and measuring the beat frequency by means of a frequency-measuring device covering the required interpolation range between the standard frequencies. Any one of a number of devices suitable for measuring the beat frequency may be used, including an accurately calibrated audio oscillator with a beat indicator, an electronic counter, or a direct-indicating frequency meter.

Perhaps the most reliable method of measuring this beat frequency is that making use of the calibrated audio oscillator, as shown in Figure 5. An advantage of this method is that a narrow-band receiver can be used when frequencies of remote transmitters must be measured in the presence of interference, noise, or fading. In severe cases of noise, a heterodyne frequency meter can be matched to the desired frequency, and the measurement can be completed with the frequency meter as a substitute source, under conditions where no other method can be used. A further advantage of this method of operation is that the difference frequency is nearly always an audible tone, and the proper source for measurement can be identified by a listening test, as can all steps of the measurement. When depending upon counting or meter indications, the operator has no check on the presence or absence of interference or noise.

By use of the heterodyne frequency meter, any desired frequency can be set up and can be measured or monitored in terms of the standard. The equipment thus not only provides a means for *measuring* frequencies, but also provides for *generating* accurately known frequencies.

The TYPE 1105-A Frequency Measuring



Equipment is an assembly of the necessary instruments for measuring unknown frequencies in terms of standard-frequency harmonics obtained from the TYPE 1100 Frequency Standard. This assembly includes an interpolation oscillator and comparison oscilloscope for the measurement of audio and beat frequencies, as well as the necessary radio-frequency detectors and calibrated oscillators used in the measurement of the higher frequencies. For a complete description, see pages 77 to 79.

### HETERODYNE FREQUENCY METERS

In addition to the heterodyne-frequency-meter oscillators included in the TYPE 1105-A Frequency Measuring Equipment, specialized types of heterodyne-frequency-meter oscillators have been developed to cover higher frequency ranges.

The TYPE 720-A Heterodyne Frequency Meter, described on page 85, contains a calibrated oscillator, using the General-Radio-developed butterfly circuit, covering the fundamental frequency range of 100 to 200 Mc, together with a suitable detector circuit and audio amplifier for detecting beat notes. The stability of this oscillator is sufficient to provide measurements to an accuracy of 0.1%. Harmonics of the oscillator enable frequency measurements up to 3000 megacycles to be made. This one instrument, being battery operated, directly calibrated, and completely portable, is the basic vhf-uhf frequency-measuring device for many laboratory or field applications.

For measurements in the frequency range above 100 Mc requiring more accurate frequency determination than that provided by the TYPE 720-A Heterodyne Frequency Meter alone (i.e. more accurate than 0.1%), the Heterodyne Frequency Meter can be used as a transfer oscillator. This places dependence on other frequency-measuring devices to provide more accurate calibration and higher stability. One such device, which has been developed especially to provide a highly ac-

curate and precise calibration for the TYPE 720-A Heterodyne Frequency Meter, is the TYPE 1110-A Interpolating Frequency Standard described on page 86. This instrument is a crystal-controlled frequency standard adjustable over the range from 1000 to 1010 kilocycles. As shown in Figure 6, this instrument consists of a 950-kc quartz-crystal oscillator, a 50- to 60-kc variable-frequency oscillator, and a mixer, filters, and output amplifier for obtaining the sum of the two oscillator frequencies as the output frequency. A worm-drive dial with 1000 scale divisions is used to vary the frequency over the 1000- to 1010-kc. range. The output frequency controls two multivibrator units, which generate harmonics of the oscillator fundamental frequency and of one tenth of this frequency, for use as accurate check points in the fundamental frequency range of the TYPE 720-A Heterodyne Frequency Meter.

Since the range of control frequency is just 1%, the frequencies of all the harmonics of the multivibrators can also be varied over a range of 1%. For the 100th harmonic the total range of adjustment is from 100 to 101 Mc for the 1-Mc multivibrator and from 10.0 to 10.1 Mc for the 100-kc multivibrator. For harmonics higher than the 100th, the 1% range is greater than 1 Mc, so that continuous coverage is obtained. Thus any point on the dial of the TYPE 720-A Frequency Meter can be accurately calibrated. For measurement of frequencies above the range of the dials on the frequency meters indicated, harmonics of the frequency meter are used. The accuracy of measurements made with the TYPE 720-A Heterodyne Frequency Meter is improved by use of the TYPE 1110-A Interpolating Frequency Standard to better than 25 parts per million.

### AUDIO FREQUENCIES

For the direct measurement of audio frequencies, the TYPE 1176-A Frequency Meter, a direct-indicating device for measuring frequencies up to 60 kc, is used. It is described on page 89 of this catalog.

FIGURE 6. Block diagram showing the functional arrangement of the TYPE 1110-A Interpolating Frequency Standard.

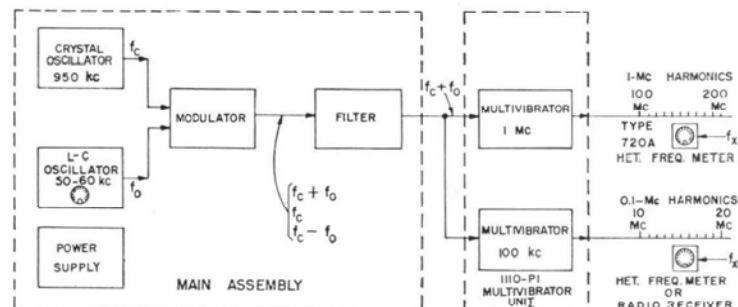



## TYPE 1100-A FREQUENCY STANDARDS

The TYPE 1100-A Frequency Standards are highly precise standards of frequency, operating on the principles outlined on pages 70 and 71. Two models are available, the TYPE 1100-AP Primary Standard and the TYPE 1100-AQ Secondary Standard. The same basic elements are used in each, and there is no difference in accuracy and stability between the two assemblies.

The primary standard is provided with a Synchronometer (synchronous motor clock) for evaluating its frequency directly in terms of standard time. The secondary standard has no Synchronometer. All other specifications are identical with those for the primary standard.

Harmonic series based on fundamentals of 0.1, 1, 10 and 100 kilocycles are available at its output terminals to furnish usable standard frequencies over a wide range. The accuracy of all output frequencies is the same and is better than one part in ten million over periods of several months.

Each assembly is supplied in a floor-type relay rack.

A functional layout of the standard is shown on page 70. Brief descriptions of the individual units are given on the following page, and complete specifications on page 76.

A specially designed assembly of frequency measuring equipment for use with these standards is described on pages 77 to 79.

General Radio Frequency Standards are known the world over for reliability and accuracy. They are used by governmental agencies, industrial plants, military services, and research laboratories. Current models have all the features of earlier ones, plus many additional advantages in convenience, size, weight, performance and appearance, that result from General Radio's continuous program of research and development in the field of frequency standardization and measurement.

The primary standard is an excellent national standard of frequency for communications ministries, and with the TYPE 1105-A Frequency Measuring Equipment, can be used to monitor or to measure the frequencies of radio stations. It is also suitable for use as a standard clock by observatories. Research laboratories and radio manufacturing plants should use the primary standard whenever the requirements make it advisable to have an independent check against time.

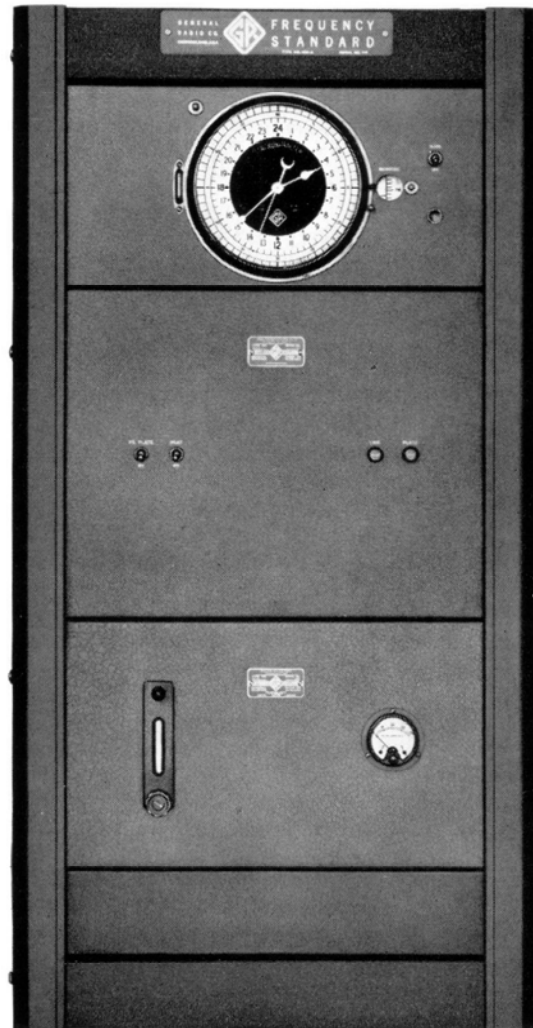

Close-up view of the TYPE 1100-AP Primary Frequency Standard. Lower part of the floor-type relay rack is not shown. The complete rack is similar to that shown in the photograph on page 77.

For many uses the timing feature of the primary standard is not needed, and the secondary standard, which offers the same stability at a lower price, can be used. With the secondary standard, an accurate check upon its frequency can be made by a comparison with standard-frequency radio transmissions such as those of the National Bureau of Standards at Washington. This comparison is adequate to evaluate the frequency of the standard to a few parts in one hundred million.



Shown below are the individual panels that make up the standard, with brief descriptions of their characteristics. Additional details of

circuit and construction will gladly be supplied upon request. Specifications and prices are listed on page 76.



#### TYPE 1103-A SYNCHRONOMETER

This panel includes a 1000-cycle synchronous motor for effectively counting the number of cycles executed by the standard piezo-electric oscillator in a standard time interval. A large, illuminated, 24-hour dial with a long sweep hand makes for easy visibility. A microdial contactor, operating once each second, and calibrated in hundredths of a second, is provided for comparison with time signals. The microdial mechanism can be phased by means of a panel control. Comparison of the synchronometer reading with standard time can be made on the microdial scale to one part in ten million over a 24-hour interval. The 1000-cycle synchronous motor is started by a 60-cycle motor controlled by a push-button on the panel.

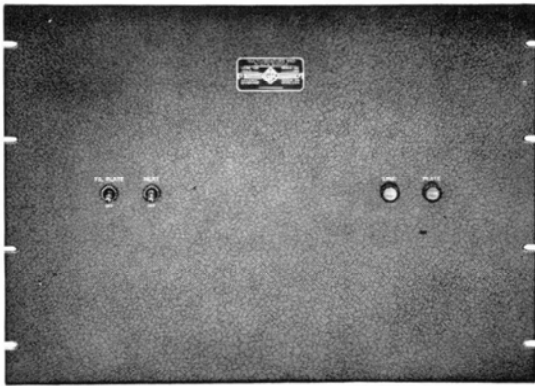

#### TYPE 1102-A MULTIVIBRATOR AND POWER SUPPLY UNIT

This unit contains four multivibrators of 100, 10, 1, and 0.1 kc frequencies, the power supply for the entire standard, and the control circuits of the temperature-control system of the TYPE 1101-A Piezo-Electric Oscillator. Concentric shielded connectors are provided for 100-kc and 10-kc harmonic outputs for radio-frequency measurements, and 10 kc, 1 kc and 0.1 kc for audio-frequency measurements. These connections are all mounted on the rear of the assembly. All tubes are accessible from the rear, without removal of any dust covers. The four multivibrators are mounted on the rear panel, which is removable without disconnecting any wiring. Mounting spacers and servicing cable are supplied to operate the multivibrators when the panel is reversed, giving access to all components of the multivibrator assembly.

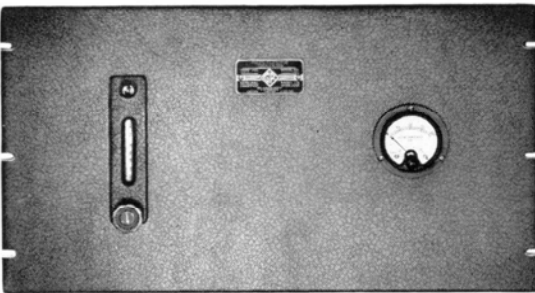

#### TYPE 1101-A PIEZO-ELECTRIC OSCILLATOR

This oscillator operates with a TYPE 1190-A Quartz Bar, which is mounted in the temperature-control unit, located at the left behind the panel. The temperature is controlled by a compensated-thermostat circuit and is maintained within 0.01°C for all ordinary ambient temperatures. The oscillator circuit assembly is mounted at the right behind the panel. All tubes are accessible from the rear without removing any dust covers.

A view of the TYPE 1190-A Quartz Bar is shown on page 71.

#### TYPE 480-PA CABINET RACK

(not shown above, see page 77 for photo)

A floor-type cabinet rack is supplied to house the complete frequency standard. When the TYPE 1105-A

Frequency Measuring Equipment is ordered with the standard, the complete assembly is mounted as shown on page 77. Openings, with removable finished covers, are provided for connections between the standard and the TYPE 1105-A Frequency Measuring Equipment.



S P E C I F I C A T I O N S

**Frequency Range:** Standard frequencies ranging from one pulse per second to frequencies of several megacycles can be obtained from this equipment.

The output frequencies are as follows: The upper frequency limit depends upon the method used to detect and utilize the harmonics. The values here quoted are easily reached when using the TYPE 1106 Frequency Transfer Units.

From 100-ke multivibrator, 100 ke and its harmonics up to 50 megacycles.

From 10-ke multivibrator, 10 ke and its harmonics up to 10 megacycles.

From 1-ke multivibrator, 1 ke and its harmonics in the audio-frequency range.

From 100-cycle multivibrator, 100 cycles and its harmonics in the lower audio range.

From the synonometer unit, one-second contactor. The time of occurrence of the contact may be phased to occur at any instant over a range of one second.

This contact is open for about 50 and closed for 950 milliseconds.

If a suitable high-frequency receiver is used to detect them, 100-ke harmonics up to 75 or more megacycles can be utilized directly. For work at higher frequencies, harmonics of an auxiliary oscillator whose fundamental is monitored against the standard at a lower frequency can be used.

**Output Voltage:** The harmonic outputs of the 100 and 10 ke are at low impedance (65 ohms). The r-m-s voltages, measured at the terminals of the frequency standard, across a 65-ohm load, are: at 100 ke, 0.2 volt; and 10 ke, 1.2 volts. The audio-frequency outputs are at low impedance (600 ohms). The r-m-s voltages measured at the terminal strip of the standard, across a 10,000-ohm load, are: 10 ke, 20 volts; 1 ke, 25 volts; 100 cycles, 20 volts. These voltages are representative only; they are not guaranteed values.

**Frequency Adjustment:** The frequency of the quartz bar in its oscillator circuit is adjusted to within 1 part in ten million of its specified frequency in terms of standard time. Slight changes in frequency may occur during shipment, but a control is provided for adjusting the frequency after installation.

**Accuracy:** When the assembly is operated in accordance with instructions, and after an aging period of a month, the rate of drift of the frequency will remain below 5 parts in 10<sup>8</sup> per day and this will decrease with time to about 0.5 part in 10<sup>8</sup> per day at the end of one year's operation.

**Frequency Stability:** The standard is designed so that ordinary changes in air pressure, ambient temperature, and line voltage have practically no effect on the frequency. The temperature coefficient of frequency of the quartz bar is less than 1 part in 10<sup>7</sup> per degree C. The temperature control is within ±0.01° C. The voltage coefficient of frequency of the crystal-controlled oscillator is less than 2 parts in 10<sup>8</sup> for line voltage changes of 10%. The average frequency variation from this cause will be substantially less.

The fluctuations of frequency of the standard over short periods, such as those required in making frequency measurements, are less than 1 part in 10<sup>9</sup>.

**Output Terminals:** The various output frequencies are made available at TYPE 874 Coaxial Connectors at the rear of the assembly. Since all necessary wiring, for all interconnections between units of the assembly, is provided in the form of cables, no connections need be made by the user other than power-supply connections, and a connection to the point where the standard frequencies are to be used.

**Tube Complement:**  
 1 — 6AC7  
 10 — 6SN7-GT  
 1 — 5R4-GY  
 1 — 1N51 (G.E. Co.)  
 1 — 6K6-GT/G  
 1 — 2 LAP-130

**Power Supply:** 105 to 125 (or 210 to 250) volts, 50 to 60 cycles.

**Power Input:** For the TYPE 1100-AQ Secondary Standard, the power demand from the supply line is approximately 155 watts; with heaters off, the power required is approximately 125 watts. For the TYPE 1100-AP Primary Standard, the corresponding figures are 175 and 145 watts, respectively.

**Accessories Supplied:** Complete set of tubes, spare sets of fuses, fusible links, pilot lights. All connecting cables, including power-supply leads, servicing cable, and complete operating instructions.

**Mounting:** All units are mounted on standard 19-inch relay-rack panels finished in black crackle lacquer, dress panel construction. A floor-type cabinet rack, black wrinkle finish, is supplied for mounting the units of the assembly. Blank panels are supplied to fill unused portion of rack.

**Dimensions:** The over-all dimensions of the assembly in floor-type cabinet rack are (height) 76<sup>3</sup>/<sub>8</sub> x (width) 22 x (depth) 20<sup>1</sup>/<sub>2</sub> inches, over-all. The available panel space is 40 rack units or 70 inches.

**Net Weight:** In floor-type racks, TYPE 1100-AP, 335 pounds, TYPE 1100-AQ, 300 pounds.

Type	Code Word	Price
1100-AP	EXCEL	\$2390.00
1100-AQ	EXACT	1690.00

PATENT NOTICE. See Notes 1, 2, 4, 5, page viii.

The TYPE 1100-AP Primary Frequency Standard consists of:  
 1 TYPE 1103-A Synonometer  
 1 TYPE 1102-A Multivibrator and Power Supply Unit  
 1 TYPE 1190-A Quartz Bar Mounted in TYPE 1101-A Oscillator  
 1 TYPE 1101-A Piezo-Electric Oscillator  
 Relay Rack, Blank Panels, Connecting Cables

The TYPE 1100-AQ Secondary Frequency Standard consists of:  
 1 TYPE 1102-A Multivibrator and Power Supply Unit  
 1 TYPE 1190-A Quartz Bar Mounted in TYPE 1101-A Oscillator  
 1 TYPE 1101-A Piezo Electric Oscillator  
 Relay Rack, Blank Panels, Connecting Cables

NOTE: TYPE 1100-A Frequency Standards are supplied in floor-type relay racks.





## TYPE 1105-A FREQUENCY MEASURING EQUIPMENT

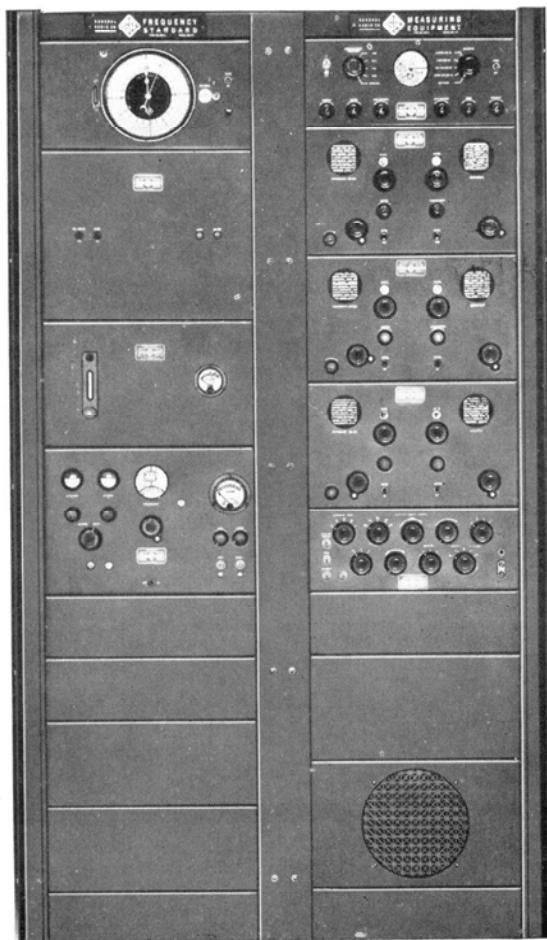

View of TYPE 1105-A Frequency Measuring Equipment with TYPE 1100-AP Primary Frequency Standard. The measuring equipment assembly is supplied with one floor-type relay rack, and the TYPE 1107-A Interpolation Oscillator mounts in the frequency standard rack, below the standard.

The TYPE 1105-A Frequency Measuring Equipment includes all the auxiliary equipment necessary for measuring unknown frequencies in terms of the TYPE 1100-A Frequency Standards. When this assembly is used in conjunction with either model of the TYPE 1100-A Frequency Standard, measurements can be made directly at frequencies up to 100 Mc. Measurements at higher frequencies can be made by using auxiliary equipment, such as receivers or oscillators, to transfer the unknown in harmonic steps to a frequency below 100 Mc. Where the frequency range to be used is smaller or the type of measurement

to be made is specialized, simpler assemblies can be furnished, and quotations will be made upon request.

The individual instruments comprising the TYPE 1105-A Frequency Measuring Assembly are available separately, and all are described in detail in the following pages.

The general method of measurement is outlined in the diagram on page 79. At radio frequencies between about 100 kc and 100 Mc, the unknown frequency is brought into the measuring system through the detector section of a frequency transfer unit or through an external radio receiver. The direct-reading scale of the frequency transfer unit gives the approximate value of the unknown frequency. For a precise determination, the beat frequency between the unknown and a standard-frequency harmonic is measured by comparison with the interpolation oscillator, the comparison being made on the oscilloscope.

Above 100 Mc an external frequency meter such as the TYPE 720-A can be used to establish a harmonic relation between the unknown and the standard frequency. Other types of stable oscillators can also be used for this purpose.

At audio frequencies, the interpolation oscillator is matched directly to the unknown frequency. A harmonic of the unknown can be used at low audio and sub-audible frequencies.

Between about 5 kc and 100 kc, the interpolation oscillator is used to produce a variable-frequency circular sweep on the oscilloscope. The unknown frequency is then determined from the oscilloscope pattern.

The accuracy of measurement that can be easily realized is  $\pm 0.1$  cycle in determining the difference between unknown and standard frequencies. The fractional accuracy varies with the frequency being measured, ranging from 2 in  $10^5$  at low frequencies to 1 in  $10^8$  at high frequencies.

By reversing the procedure of measurement, a precisely known frequency of any value between 100 kc and 200 Mc can be generated. The desired frequency is available at the output terminals of a frequency transfer unit. At audio frequencies, from the interpolation oscillator, audio frequencies between 0 and 5000 cycles are available.

This equipment is the result of a quarter century of continuous development, and simplicity of operation has, next to accuracy, been the guiding principle in its design.



**TYPE 1109-A COMPARISON OSCILLOSCOPE**

This unit contains a cathode ray oscilloscope, with its power supply; selecting, smoothing, and phase-shifting networks for circular sweeps at line frequency, 0.1, 1, and 10 kc standard frequencies, and at a variable frequency obtained from the interpolation oscillator; and a selector providing for all necessary and convenient comparisons required in making frequency measurements. Most patterns are presented on a circular sweep by radial deflection.

For complete description, see page 84.

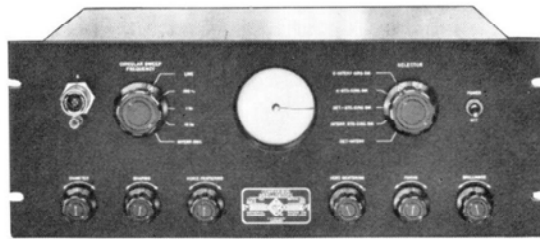

**TYPE 1106-A, -B, -C FREQUENCY TRANSFER UNITS**

(3 Panels)

Each of these units contains a heterodyne frequency meter and heterodyne detector, with direct-reading scales. Ranges are as follows:

- TYPE 1106-A 100 kc to 2000 kc
- TYPE 1106-B 1 Mc to 10 Mc
- TYPE 1106-C 10 Mc to 100 Mc

The harmonic output of the frequency meter can be used at frequencies higher than those covered by the dial ranges, as explained in the operating instructions. The output of the frequency meter is adjustable by a panel control, as is the regeneration of the heterodyne detector.

For complete description, see page 80.

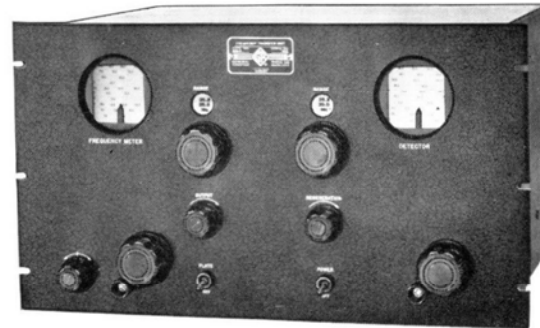

**TYPE 1108-A COUPLING PANEL**

This unit is the centralized control point at which all switching and level adjustments necessary for using the various combinations of measuring equipment can be easily and quickly carried out.

For complete description, see page 83.

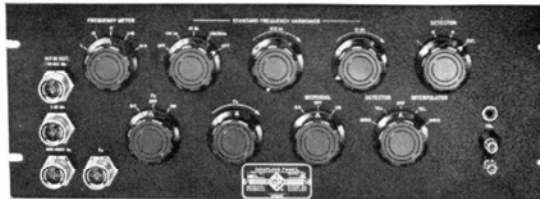

**TYPE 1107-A INTERPOLATION OSCILLATOR**

This unit is a direct-reading audio-frequency oscillator covering frequencies from 0 to 5000 cycles. It is used to measure the audio-frequency difference between the unknown frequency and a standard 10-kc harmonic. Provision is made, on two scales, so that results can be obtained by addition only, avoiding subtraction. A mixer circuit is provided with controls for output of the interpolator and for the unknown frequency, so that a maximum beat amplitude can be obtained. A meter indicates output voltage and can be used as a beat indicator for matching the interpolator and unknown frequencies.

For complete description, see page 82.



**TYPE 480-MA RELAY RACK**

The individual units, with the exception of the TYPE 1107-A Interpolation Oscillator, are mounted in the TYPE 480-MA Relay Rack. At the base of the rack is

mounted a TYPE 1105-P1 Speaker for audible monitoring of beat tones.

All connections between standard and measuring assembly are made by means of patch cords, which are supplied.

Each of the instruments comprising the TYPE 1105-A Frequency Measuring Equipment is available separately. All are completely described in the following pages, and those descriptions should be consulted for further details of design and construction, net weight, dimensions, etc.



# TYPE 1105-A FREQUENCY MEASURING EQUIPMENT

## SPECIFICATIONS

**Terminals and Connections:** All instruments are equipped with TYPE 874 Coaxial Connectors on the rear of each unit. Suitable connecting cords are supplied.

**Power Supply:** 105 to 125 (or 210 to 250) volts, 50-60 cycles. Other voltages or frequencies on special order only.

**Power Input:** 200 watts.

**Accessories Supplied:** Spare sets of fuses; blank panels; connecting cables, including power supply cords.

**Mounting:** The complete assembly, with the exception of TYPE 1107-A Interpolation Oscillator, mounts in a standard 19-inch TYPE 480-MA Cabinet Rack. This rack includes service outlets for each instrument. The interpolation oscillator mounts in the frequency standard rack, as shown in the photograph on page 77.

**Dimensions:** (Height) 76 1/8 x (width) 22 x (depth) 20 1/2 inches, over-all. Total rack space is 40 rack units, or 70 inches.

**Net Weight:** 370 pounds, including rack.

Type	Code Word	Price
<b>1105-A</b>   Frequency-Measuring Equipment.....	MITER	<b>\$5175.00</b>

PATENT NOTICE. See Note 4, page viii.

The TYPE 1105-A Frequency Measuring Equipment consists of:

- 1 TYPE 1109-A Comparison Oscilloscope
- 1 TYPE 1106-A Frequency Transfer Unit
- 1 TYPE 1106-B Frequency Transfer Unit

- 1 TYPE 1106-C Frequency Transfer Unit
- 1 TYPE 1108-A Coupling Panel
- 1 TYPE 1105-P1 Speaker Mounted on Relay Rack
- 1 TYPE 1107-A Interpolation Oscillator
- Relay Rack, Blank Panels, and Connecting Cables

This diagram shows in functional form the operation of the TYPE 1105 Frequency Measuring Assembly. The TYPE 1108 Coupling Panel is the central unit from which all operations are controlled.

The unknown frequency  $f_x$  and a series of standard frequency harmonics are applied through attenuators

to the detector in the frequency transfer unit. The unknown frequency can then (1) be estimated quickly from the calibration of the detector, (2) be determined more accurately by use of the heterodyne frequency meter, or (3) be measured precisely by use of the interpolation oscillator.

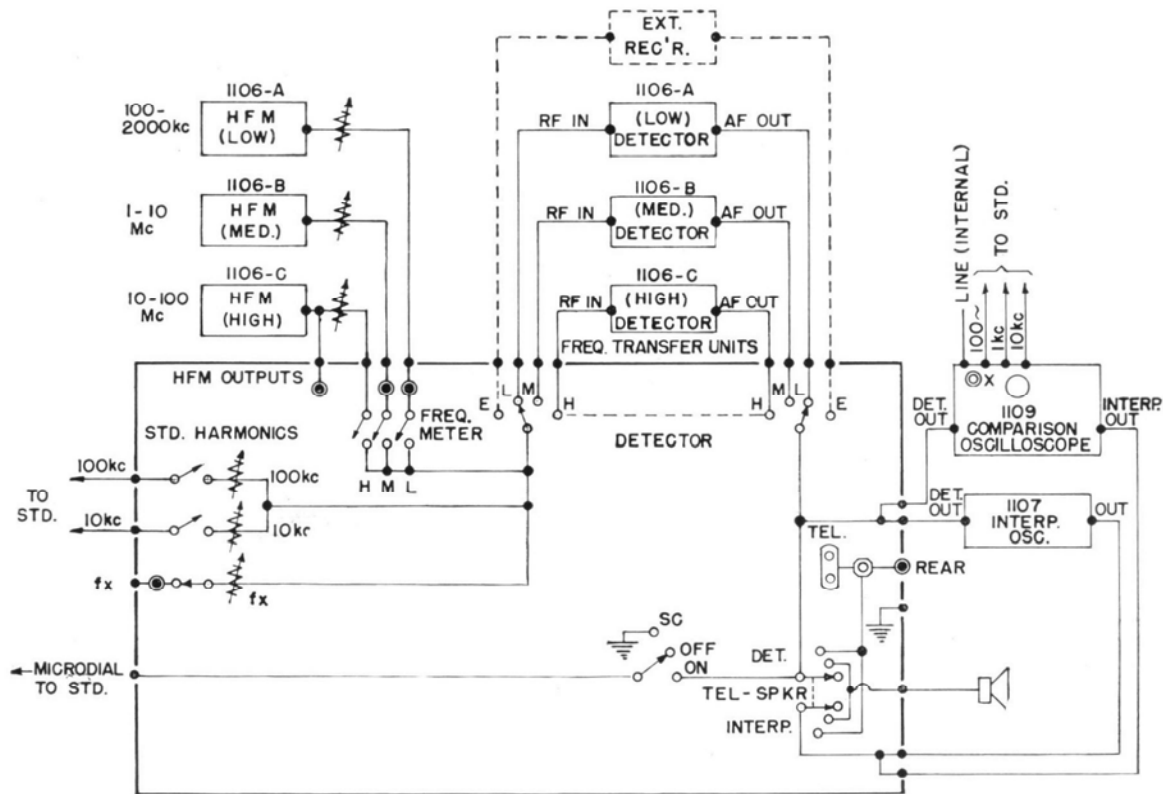



## TYPE 1106 FREQUENCY TRANSFER UNITS

**USES:** The TYPE 1106 Frequency Transfer Units are utilized in transferring an unknown frequency for measurement against a frequency standard, or for transferring a frequency of known value (determined against the standard) to an output circuit. The direct-reading frequency calibrations will give the approximate value of an unknown frequency or the approximate value of a desired frequency in the output circuit.

When used with a frequency standard, these units provide means for rapidly identifying the harmonics of the standard; for accurately matching the heterodyne frequency meter to the unknown frequency; for use as a substitute source in measuring frequencies under conditions of noise, fading, or of intermittent operation of the transmitter; and for obtaining a frequency of any desired value, accurately known in terms of the frequency standard.

The Frequency Transfer Units can also be used as general-purpose calibrated frequency meters and detectors.

**DESCRIPTION:** The TYPES 1106-A, 1106-B and 1106-C Frequency Transfer Units are identical except for their frequency ranges which are:

TYPE 1106-A	100 kc to 2000 kc
TYPE 1106-B	1 Mc to 10 Mc
TYPE 1106-C	10 Mc to 100 Mc

Each consists of a heterodyne frequency meter (with harmonic-generating circuits and output control) and a heterodyne detector (with audio-frequency amplifier and regeneration control).

The heterodyne-frequency-meter oscillator circuit is a highly stable oscillator having a frequency range of 2 to 1 in two (1106-A) or three steps (1106-B, -C). A direct-reading frequency scale is provided for the fundamental and selected harmonic ranges, covering 10 to 1 in frequency (20 to 1 on 1106-A). The harmonic output can be used at frequencies higher than those covered on the dial ranges; for example, using the fundamental frequency scales and reading ten times the scale value gives the coverage of the tenth harmonic. An auxiliary fine-tuning control is provided for easily setting zero beat.

The heterodyne detector has range-switching and direct-reading frequency scales covering the rated range of the unit. The detector can be operated either in the non-oscillating or oscillating condition by use of the regeneration control. When oscillating, it is especially useful in obtaining an exact zero beat setting between the frequency meter and a signal frequency, by the three-oscillator method, the detector serving as the third oscillator. When not oscillating, it produces the beat between the standard harmonic and the un-



known frequency. An audio-frequency amplifier with an output impedance of approximately 600 ohms is provided.

On both the heterodyne frequency meter and detector direct-reading frequency scales, nearly 360-degree rotation of the drum dials is used. Both are approximately straight-line-frequency in calibration. Operation of the range selectors automatically sets the pointers so that the possibility of error in reading one of the several scales on the dial is greatly reduced.

**FEATURES:** ➤ Dials are direct reading in frequency for both the frequency meter and the detector.

➤ Range dials are illuminated and are mounted behind panel and viewed through a window.

➤ Range switching for both frequency meter and detector.

➤ The heterodyne frequency meter is designed for a high degree of frequency stability, and drift is negligible for the specified conditions of use.

**S P E C I F I C A T I O N S**

**Frequency Range:**

TYPE 1106-A	100 kc to 2000 kc	(9 ranges)
TYPE 1106-B	1 Mc to 10 Mc	(10 ranges)
TYPE 1106-C	10 Mc to 100 Mc	(10 ranges)

The heterodyne frequency meters all have 2:1 fundamental ranges, with calibrated direct-reading harmonic scales. The heterodyne detectors all have fundamental ranges covering the specified band.

**Calibration:** The heterodyne frequency meter dials are calibrated as follows:

TYPE 1106-A HFM	1 kc intervals	100-280 kc
	2 kc intervals	280-560 kc
	5 kc intervals	560-1000 kc
	10 kc intervals	1000-2000 kc
TYPE 1106-B HFM	5 kc intervals	1.0-2.0 Mc
	10 kc intervals	2.0-4.0 Mc
	20 kc intervals	4.0-5.0 Mc
	10 kc intervals	5.0-10.0 Mc
TYPE 1106-C HFM	20 kc intervals	10.0-20.0 Mc
	100 kc intervals	20.0-40.0 Mc
	200 kc intervals	40.0-50.0 Mc
	100 kc intervals	50.0-100.0 Mc

The heterodyne detector dials are calibrated with somewhat greater frequency intervals, but the intervals permit reasonable estimation of frequency.

**Accuracy:** The accuracy of the heterodyne frequency meter calibration permits positive identification of harmonics when used with a frequency standard. Used individually, the calibration can be relied upon to ±0.1 per cent.

**Frequency Stability:** The circuits of the oscillators used for the heterodyne frequency meters are designed for high stability against changes in supply voltage or changes in tube capacitances. The heterodyne detector stability is not as good but is sufficiently high so that no difficulty is encountered from variations in making frequency measurements.

**Input and Output Circuits:** The harmonic output of the heterodyne frequency meters is available at shielded coaxial connectors for use with 50-65 ohm concentric cable. Harmonics of the fundamental frequency to at least the 10th are usable. The radio-frequency input and the audio-frequency output connections of the heterodyne detector are shielded coaxial connectors. The input circuit is suitable for use with 50-65 ohm cable; the output impedance is approximately 600 ohms.

**Power Supply:** 105 to 125 (or 210 to 250) volts, 50-60 cycles. Other voltages or frequencies on special order only.

**Power Input:** 40 watts.

**Tube Complement:**

TYPE 1106-A, -B	TYPE 1106-C
3 — 6SJ7	1 — 6SJ7
1 — 6J5GT	1 — 6J5GT
1 — 6SN7GT	1 — 6SN7GT
1 — 1N51 (G.E. Co.)	1 — 6X4
1 — 6X4	1 — 6AK5
1 — 0D3	1 — 0D3
	2 — 9002

**Accessories Supplied:** Spare fuses, CAP-35 line connector cord, three TYPE 874-C62 Cable Connectors.

**Controls:** Power ON-OFF switch; heterodyne frequency meter PLATE supply switch; heterodyne frequency meter and heterodyne detector RANGE (coil selector) switches; frequency controls; heterodyne frequency meter OUTPUT control; heterodyne detector REGENERATION control.

**Mounting:** Standard 19-inch relay-rack mounting; dress-panel construction; black crackle lacquer.

**Dimensions:** Panel (length) 19 x (height) 10½ inches; behind panel, (length) 17 x (height) 10¼ x (depth) 12¾ inches.

**Net Weight:** 47¾ pounds.

Type	Code Word	Price
1106-A Frequency Transfer Unit 100-2000 kc.....	ABOUT	\$975.00
1106-B Frequency Transfer Unit 1-10 Mc.....	ACTOR	975.00
1106-C Frequency Transfer Unit 10-100 Mc.....	ADEPT	975.00

PATENT NOTICE. See Note 4, page viii.

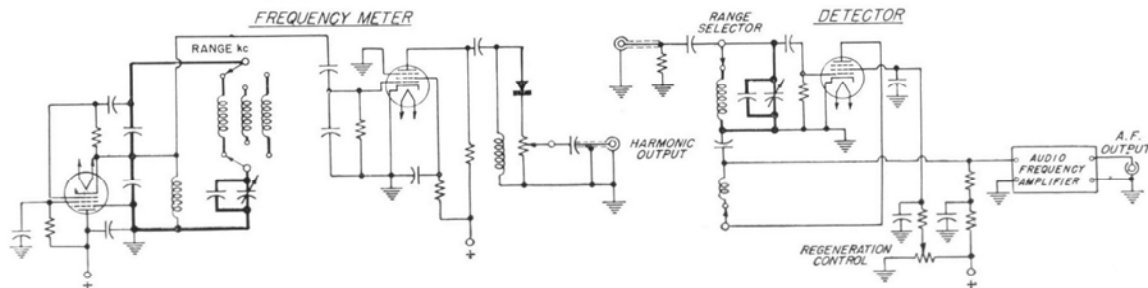



## TYPE 1107-A INTERPOLATION OSCILLATOR

**USES:** The principal use of the TYPE 1107-A Interpolation Oscillator is, in connection with a frequency standard, to measure the difference between the unknown frequency and a known standard harmonic. The direct-reading linear scales of 0 to 5000, and 5000 to 10,000 cycles make possible the rapid evaluation of the frequency difference, by *addition* only, with high accuracy. While the dials are marked as described, the actual frequency range is 0-5000 cycles.

The linear scale of this oscillator also makes it useful for other types of work where accurate frequency increments are desired.

**DESCRIPTION:** The oscillator is of the beat-frequency type, with the radio-frequency oscillators operating in the region of 45-50 kc. The circuits are designed for exceptional stability of frequency against supply-voltage changes, tube-capacitance changes and tube replacements. A tube plate-supply regulator is then employed as a further safeguard.

The variable-frequency-oscillator frequency is controlled by a precision variable air capacitor, the fixed oscillator frequency by a fixed air capacitor. The inductors of both oscillator circuits are wound on ceramic forms and are shielded, effectively eliminating unwanted coupling and reducing the effects of changes in ambient temperature.

An output voltmeter is provided, which can

also be used as a beat indicator for matching the oscillator output frequency to an unknown audio frequency. Individual controls are provided for the oscillator output and unknown-frequency voltages in order to secure the maximum beat amplitude at any level. The oscillator output voltage is practically constant over the whole range of frequency.

**FEATURES:** ➤ The fixed oscillator is provided with a switch that permits changing its frequency by exactly 5000 cycles. By this change of frequency the oscillator can be fitted with a scale reading 5000-10,000 cycles. For the measurement of a frequency lying below the standard frequency, the beat frequency need not be subtracted from the standard frequency to obtain the unknown frequency. Instead, the 5000-10,000 cycle scale is used and the reading is added to the frequency of the next lower standard-frequency harmonic.

➤ An indicator light operated by the switch indicates the proper scale to be read.

➤ Stability of output frequency, and linear, easily read scales are features of great convenience in use.

➤ For measuring very small frequency increments, two direct-reading incremental frequency dials (one for the 0-5000 scale and one for the 5000-10,000 cycle scale) are provided.



**SPECIFICATIONS**

**Actual Frequency Range:** 0-5000 cycles per second.  
**Dial Calibrations:** DIRECT: 0-5000 cycles, with the oscillator frequency increasing from 0 to 5000 divisions on the scale. REVERSE: 5000-10,000 cycles with the oscillator frequency decreasing from 5000 cycles to zero while scale reading goes from 5000-10,000 divisions.  $\Delta f$  REVERSE and  $\Delta f$  DIRECT:  $\pm 10$  cycles.  
**Accuracy:** The instrument is aligned to agree with the linear direct-reading scales to within  $\pm 2$  cycles.  
 The variable capacitor is provided with a precision worm drive so that precise frequency settings can be made. Small residual errors are easily and quickly removed in the region of any frequency in the range by fine adjustment of the zero with reference to a frequency standard having a 1-kc or 0.1-kc output, or both. For evaluating very small frequency differences, independent, direct-reading frequency-increment dials are provided.  
**Output:** The output voltage is adjustable up to 15 volts. The output-circuit impedance is approximately 600 ohms.  
**Mixer Circuit:** A mixer circuit, with volume control, is provided for injecting a frequency to be measured into the amplifier circuit. Beats may be observed on the output meter, or by means of head telephones or speaker.

**Power Supply:** 105 to 125 (or 210 to 250) volts, 50-60 cycles. Other voltages or frequencies on special order only.  
**Power Input:** 50 watts, approximately.  
**Controls:** ON-OFF switch; DIRECT and REVERSE scale switch; Two  $\Delta f$  and zero-set controls; main FREQUENCY control; OUTPUT and INPUT (mixer) volume controls.  
**Meters:** Output voltmeter; used also as a beat indicator.  
**Terminals:** Terminals, both on panel and at rear, are provided for both mixer input and oscillator output. Panel terminals are universal for two-pin or coaxial connectors. Rear terminals are for coaxial connectors.  
**Tube Complement:**  
 2 — 6AC7                      1 — 0D3                      2 — 6SN7GT  
 3 — 6J5GT                      1 — 6X5GT  
**Accessories Supplied:** Spare fuses; TYPE CAP-35 Power Cord; four TYPE 874-C62 Cable Connectors.  
**Mounting:** Standard 19-inch relay-rack; dress panel construction; black crackle finish.  
**Dimensions:** Panel (length) 19 x (height) 12 $\frac{1}{4}$  inches; behind panel, (length) 17 $\frac{1}{4}$  x (height) 12 x (depth) 12 inches.  
**Net Weight:** 41 $\frac{1}{2}$  pounds.

Type	Code Word	Price
<b>1107-A</b>   Interpolation Oscillator.....	BARON	<b>\$975.00</b>

PATENT NOTICE. See Note 4, page viii.

**TYPE 1108-A  
COUPLING PANEL**



**USES:** This coupling panel is designed specifically for use as the centralized control panel in a frequency-measuring equipment employing a TYPE 1100-AP Primary Frequency Standard (or TYPE 1100-AQ Secondary Frequency Standard). The panel carries the necessary switches and volume controls for all operations in making frequency measurements.

meter outputs of 1106-A, 1106-B and 1106-C heterodyne frequency meter sections; STANDARD FREQUENCY HARMONIC selector, selecting 100-kc or 10-kc harmonic outputs, or combination; individual volume controls; DETECTOR selector, for selecting input and output circuits of 1106-A, 1106-B, 1106-C, or an external detector (or receiver); an ON-OFF switch and volume control for frequency being measured; MICRODIAL switch; TEL-SPEAKER switch for transferring between telephones and speaker and between detector and interpolator outputs.

**DESCRIPTION:** The instrument contains the following controls: FREQUENCY METER, for selecting and combining the frequency

**SPECIFICATIONS**

**Terminals:** At rear: by 24 shielded coaxial connectors to all sources and instruments required; rear telephone connection for use when adjusting standard against standard-frequency transmissions. At front: by shielded coaxial connectors, harmonic output circuits of 1106-A, 1106-B, and 1106-C heterodyne frequency meter sections; input connection for frequency being measured;

by two-point or standard telephone jack, connections for telephone receivers.  
**Mounting:** Standard 19-inch relay-rack mounting; dress panel construction; black crackle finish.  
**Dimensions:** Panel (length) 19 x (height) 7 inches; behind panel, (width) 17 $\frac{1}{4}$  x (height) 6 $\frac{3}{4}$  x (depth) 6 $\frac{1}{2}$  inches. **Net Weight:** 16 pounds.

Type	Code Word	Price
<b>1108-A</b>   Coupling Panel.....	BATTY	<b>\$280.00</b>

PATENT NOTICE. See Note 4, page viii.



## TYPE 1109-A COMPARISON OSCILLOSCOPE

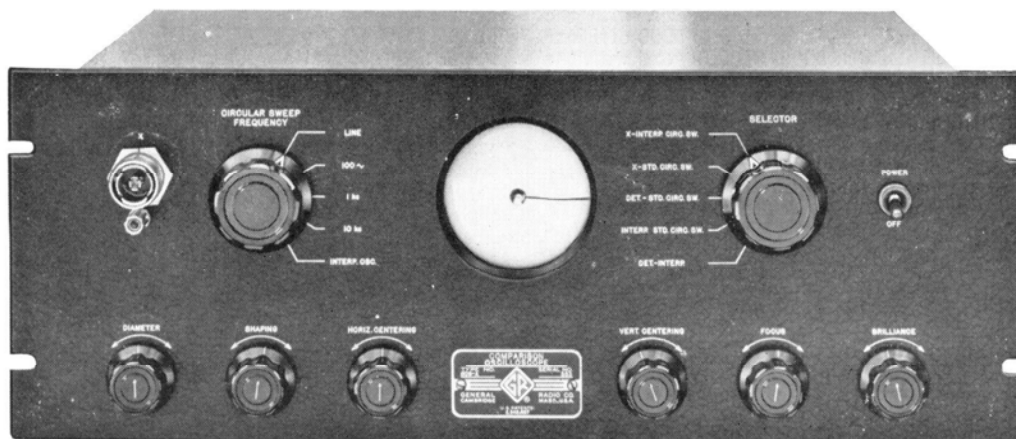

**USES:** This instrument is particularly intended for use with a TYPE 1100-AP Primary Frequency Standard (or TYPE 1100-AQ Secondary Frequency Standard) as an aid in making interpolations or checking calibrations with high accuracy. With such standards and associated measuring equipment, the TYPE 1109-A Comparison Oscilloscope provides a convenient means of measuring audio and carrier frequencies or of calibrating oscillators in these frequency ranges.

**DESCRIPTION:** The TYPE 1109-A Comparison Oscilloscope contains a 3-inch, radial-deflection cathode-ray tube and its power supply. Selective amplifiers with power supply, phase-shift networks, and controls are provided for obtaining circular sweeps at the power line frequency, at 0.1, 1, and 10 kc from the frequency standard, and at variable frequency obtained from the TYPE 1107-A Interpolation Oscillator. A radial deflection amplifier is provided, for displaying the input signal on

the circular sweep base. Switching is provided for selecting the sweep frequencies and for selecting any one of the several operations normally involved in making frequency measurements or calibrations.

**FEATURES:** ➤ The general use of circular sweeps provides symmetrical and readily interpreted patterns.

➤ By overloading the deflection amplifier the operator can identify easily frequency ratios involving much higher integers than can be identified in Lissajous patterns.

➤ Ordinarily in the use of calibrated oscillators, it is not necessary to identify a pattern; it is only necessary to adjust the oscillator so that the pattern stands still. A system of known frequencies is easily established on the basis of the *type* of pattern obtained. When used on base frequencies 10 or 100 times higher, the *same types* of pattern correspond to frequencies just 10 or 100 times higher than the original system of known frequencies.

### SPECIFICATIONS

**Frequency Range:** Useful patterns can be obtained over the frequency range from very low audio frequencies to radio frequencies of a few hundred kilocycles. In the range up to 100 kilocycles, an input voltage of 0.5 volt gives full radial deflection. Larger voltages give very useful square-wave radial deflections.

**Controls:** ON-OFF switch; BRILLIANCE, FOCUS, and CENTERING adjustments for cathode-ray tube; sweep DIAMETER, and SHAPING controls; FREQUENCY selector for circular sweep; SELECTOR for sources to be compared.

**Terminals:** At rear, by coaxial connectors for standard frequencies and for sources to be compared; on panel by universal two-point and coaxial connector to source being measured or calibrated (0 to 100 kc or more).

**Power Supply:** 105 to 125 (or 210 to 250) volts, 50-60

cycles. Other voltages or frequencies on special order only.

**Power Input:** 30 watts, approximately.

**Tube Complement:** 1 — TYPE 3DP1A, 3" radial deflection Cathode-Ray Oscilloscope

2 — 6SN7GT 1 — 2X2A 1 — 6X5-GT

1 — 6J5GT 1 — 6SJ7

**Accessories Supplied:** Spare fuses; TYPE CAP-35 Power Cord; five TYPE 874-C62 Coaxial Connectors; one TYPE 274-MB Double Plug.

**Mounting:** Standard 19-inch relay-rack mounting; dress panel construction; black crackle finish.

**Dimensions:** Panel (length) 19 x (height) 7 inches; behind panel, (width) 17¼ x (height) 6¾ x (depth) 12½ inches.

**Net Weight:** 35 pounds.

Type	Code Word	Price
1109-A Comparison Oscilloscope.....	BASIN	\$525.00

PATENT NOTICE. See Note 4, page viii.





## TYPE 720-A HETERODYNE FREQUENCY METER

**USES:** The TYPE 720-A Heterodyne Frequency Meter is used for accurate frequency measurements up to 3000 megacycles. When it is used in conjunction with the TYPE 1110-A Interpolating Frequency Standard, frequency measurements can be made with an accuracy of  $\pm 25$  parts per million or better.

**DESCRIPTION:** The principal elements of the instrument are a calibrated oscillator, a crystal detector, and a three-stage wide-band amplifier. The instrument uses the General-Radio-developed butterfly circuit, which allows simultaneous variation of inductance and capacitance in the oscillator circuit without sliding contacts. This permits smooth, stable, and continuous adjustment of frequency. The oscillator tunes from 100 to 200 megacycles and produces usable harmonics up to 3000 megacycles. For measurements below 100 megacycles, harmonics of the unknown are used.

The entire assembly is battery-operated, completely self-contained, and mounted in a portable, fabric-covered cabinet. An a-c power supply to fit the battery compartment is also available.

**FEATURES:** ➤ No direct connection to the source under measurement is usually required, because of the high sensitivity and the adjustable antenna mounted on the panel.

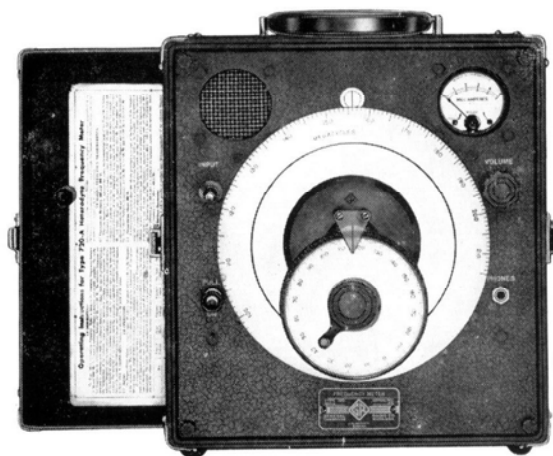

- A wide range of frequencies can be measured: 10 to 3000 megacycles.
- The dial arrangement allows small frequency increments to be measured precisely.
- The butterfly type of tuned circuit eliminates all sliding contact difficulties.
- Provision for either visual or aural zero beat indication.
- Either batteries or an a-c power supply can be used. This makes the instrument ideally suited for both field and laboratory use.

### S P E C I F I C A T I O N S

**Frequency Range:** 100 to 200 megacycles on fundamentals, 10 to 3000 megacycles on harmonics.

**Beat Indication:** With strong signals beat notes can be heard through a small dynamic speaker on the front panel. A visual indication can be obtained from the panel meter. A jack is provided for headphones and is located on the front panel.

**Band Width:** The three-stage amplifier has an effective band width of 50 kc, so that a visual indication can be obtained, even when the frequency under measurement is not stable enough to produce a steady audio beat.

**Calibration:** The main dial is calibrated in one-megacycle divisions.

The slow-motion drive is geared to the tuning unit, and its dial carries 250 uniform divisions. Each one of these divisions corresponds to a frequency change of approximately 0.01%.

**Accuracy:** The over-all accuracy of measurement is  $\pm 0.1\%$ . For measurements requiring greater accuracy, the frequency meter can be used with the TYPE 1110-A Interpolating Frequency Standard.

**Temperature and Humidity Effects:** Over the range of room conditions normally encountered, temperature and humidity do not affect the accuracy of the instrument.

**Input Terminal:** A short adjustable rod serves as an-

tenna to pick up the unknown signal. Additional length of wire can be attached.

**Tube Complement:**

- 1 — 1N5-GT/G
- 1 — 1D8-GT
- 1 — 958-A

**Power Supply:** A Burgess 6TA60 Battery is supplied with the instrument. For a-c operation the TYPE 1261-A Power Supply can be used (see page 147) but must be ordered separately.

**Mounting:** The TYPE 720-A Heterodyne Frequency Meter is mounted in a shielded carrying case of durable airplane-luggage construction. Complete operating instructions are attached to the cover, and a complete wiring diagram, with circuit constants, is attached to the inside of the cabinet. Panel is finished in black crackle lacquer.

**Accessories Supplied:** One 1N21-B Crystal is supplied as a spare in addition to the one in the instrument.

**Accessories Recommended:** Headphones which can be plugged in on the front panel, and which can be stored in the cover of the instrument.

**Dimensions:** (Height) 14 x (width) 12½ x (depth) 10½ inches, over-all, including cover and handle. Panel, 10¾ x 11¾ inches.

**Net Weight:** 27½ pounds, with battery.

Type		Code Word	Price
720-A	Heterodyne Frequency Meter.....	FANCY	\$440.00
1261-A	A-C Power Supply.....	NUTTY	128.00

PATENT NOTICE. See Note 10, page viii.



## TYPE 1110-A INTERPOLATING FREQUENCY STANDARD

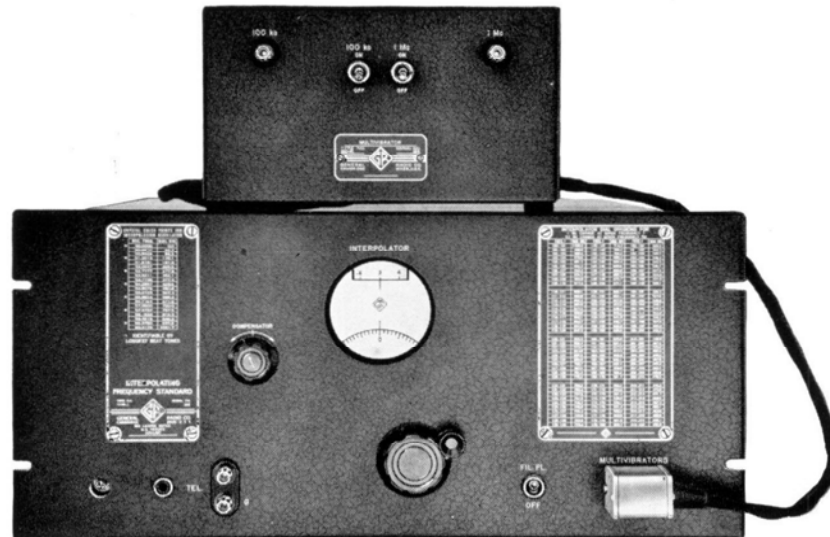

**USES:** This instrument is a precision interpolator for use with heterodyne frequency meters, such as the TYPE 720-A, in making frequency measurements in the ultra-high-frequency range, up to 2000 or 3000 Mc. It can be used for making frequency measurements from 10 Mc up to several hundred Mc in conjunction with high-frequency receivers, provided their frequency calibrations are sufficiently good to identify frequencies separated by as little as  $\frac{1}{2}\%$ . The TYPE 1110-A Interpolating Frequency Standard and the TYPE 720-A Heterodyne Frequency Meter are particularly well suited for making measurements of center frequency and frequency swing on mobile F-M transmitters.

**DESCRIPTION:** The block diagram indicates the essential elements of the instrument: (1) a frequency standard, variable over a range of 1000 to 1010 kc, or  $1\%$ , and (2) a multivibrator unit for frequencies of 1 Mc and 100 kc.

The frequency standard consists of a 950-kc crystal-controlled oscillator; a highly stable, 50–60 kc, bridge-type, variable-frequency, L-C oscillator; a modulator; and filter for selecting the sum of the two frequencies as the final output. The dial of the variable oscillator has 1000 divisions to cover 10 kc.

The  $1\%$  range of the output frequency means that the frequency range of any multivibrator harmonic is also  $1\%$ . The 100th harmonic of the 1-Mc multivibrator can therefore be adjusted continuously from 100 Mc to 101 Mc, giving complete coverage over

this interval. At 101 Mc and higher harmonics, the range from any multiple of 1 Mc to the next higher multiple is less than  $1\%$  and so these ranges are covered by less than full-scale variation on the variable frequency oscillator dial.

When the 100-kc multivibrator is used, the 100th harmonic again has a range of  $1\%$  as the standard frequency is changed over the full range of the dial, covering 10.0 to 10.1 Mc, and for all higher multiples the range from one multiple to the next higher is covered by less than full-scale range of the variable frequency oscillator dial.

The multivibrator harmonics give complete frequency coverage from 100 Mc upward, for the 1 Mc unit, and from 10 Mc upward, for the 100 kc unit. When the Interpolating Frequency Standard is used with the TYPE 720-A Heterodyne Frequency Meter, having a range of 100–200 Mc, only the harmonics from the 100th to the 200th are used.

The dial of the TYPE 720-A, for example, covers 100–200 Mc with calibration marks at each megacycle. With the dial of the variable-frequency oscillator at zero, the standard output frequency is exactly 1 Mc, and all harmonics are therefore standard frequencies, which can be used to check the heterodyne frequency meter at any scale graduation.

If the heterodyne frequency meter has been set to zero beat with a frequency to be measured, an approximate reading of the unknown frequency is given at once on the dial. As an example, suppose the reading to be 162.3 Mc. Using the Interpolating Frequency Standard,



the 1-Mc multivibrator output is coupled to the frequency meter. The oscillator dial is then advanced from zero until the 162nd harmonic (identified by the 720-A dial reading) is advanced from 162.0 Mc to 162.3 Mc approximately where zero beat is set. The increment in frequency is determined from the variable oscillator dial and is added to 162.0 Mc to give the final result.

**FEATURES:** ➤ This instrument is designed for operation by zero beat adjustments only, overcoming the need for wide-band circuits or wide-band interpolating methods.

➤ All frequency increments are taken as positive, avoiding all need for subtraction or determining the sign of frequency increments.

**S P E C I F I C A T I O N S**

**Frequency Range:** The output frequency range of the 1110-A Interpolating Frequency Standard is from 1000 to 1010 kc. The output frequencies of the 1110-P1 Multivibrator Unit are 1.0- and 0.1-Mc fundamentals with harmonics up to 200 or more.

**Calibration:** The variable-frequency oscillator dial has 1000 divisions corresponding to 0.001 per cent or 10 parts per million per division.

A list of check settings is provided on the panel. This check can be made at any time by simply plugging a set of headphones into the jack or binding posts provided on the panel. A trimmer control on the panel provides for adjusting the oscillator to agreement with the crystal.

To facilitate conversion of the dial readings from their basic percentage or parts per million values of frequency increment to fractions of a megacycle or of 0.1 Mc (100 kc), a table listing the number of dial divisions for frequency increments of 1.0 Mc and 0.1 Mc at each harmonic from 100 to 220 is given on the panel. A simple slide-rule ratio then gives the desired frequency increment.

**Crystal Oscillator:** The crystal oscillator is adjusted to within 1 part in a million of correct frequency at room temperature. It should be reliable to within  $\pm 10$  parts per million at ordinary room temperatures. The crystal frequency can be checked and adjusted in terms of standard frequency transmissions from WWV using an external receiver, maintaining the variable oscillator at exactly 50 kc in terms of the crystal.

➤ Means are provided for checking the alignment of the variable-frequency-oscillator calibration in terms of the 950-kc crystal frequency.

➤ Since harmonics of the multivibrators fall at all standard frequencies transmitted by the U. S. Bureau of Standards (WWV), it is possible to check the absolute accuracy, including the frequency of the 950-kc crystal, by use of a suitable receiver.

➤ To permit bringing the multivibrator output close to high-frequency equipment, the multivibrator unit is connected to the standard-frequency unit by means of a cable. The small multivibrator unit can then be moved around without moving the larger unit.

**Accuracy of Measurement:** The over-all accuracy of measurement is  $\pm 25$  parts per million using the oscillator dial directly. If the oscillator is carefully trimmed in terms of the crystal, the over-all accuracy is limited principally by the error of the crystal.

**Tube Complement:**  
 2 — 6AC7      3 — 6J5GT  
 4 — 6SN7-GT   1 — 5R4GY  
 1 — 6SJ7      1 — 9001  
 1 — 6SA7      1 — 2LAP-430 (Bridge Circuit Lamp)

**Power Supply:** Either 105-125 or 210-250 volts, 50 to 60 cycles.

**Power Input:** 85 watts from 115-volt, 60-cycle line.

**Mounting:** TYPE 1110-A, standard 19-inch relay rack; dress panel construction; black crackle finish. TYPE 1110-P1 (attached to 1110-A by cable), small metal cabinet.

**Accessories Supplied:** TYPE CAP-35 Power Cord; TYPE 1110-P1 Multivibrator Unit with 5-foot connecting cable; spare fuses; Quartz Plate (shipped installed).

**Accessories Required:** Head telephones.

**Dimensions:** 1110-A Panel (length) 19 x (height)  $8\frac{3}{4}$  inches; behind panel, (length)  $17\frac{1}{4}$  x (height)  $8\frac{3}{8}$  x (depth) 14 inches. 1110-P1 (length)  $9\frac{1}{4}$  x (height)  $5\frac{1}{4}$  x (depth)  $5\frac{1}{4}$  inches.

**Net Weights:** TYPE 1110-A assembly, 40 pounds; TYPE 1110-P1 Multivibrator Unit,  $7\frac{1}{2}$  pounds.

Type	Code Word	Price
1110-A   Interpolating Frequency Standard.....	RAVEN	\$775.00

PATENT NOTICE. See Notes 1, 2, 5, page viii.

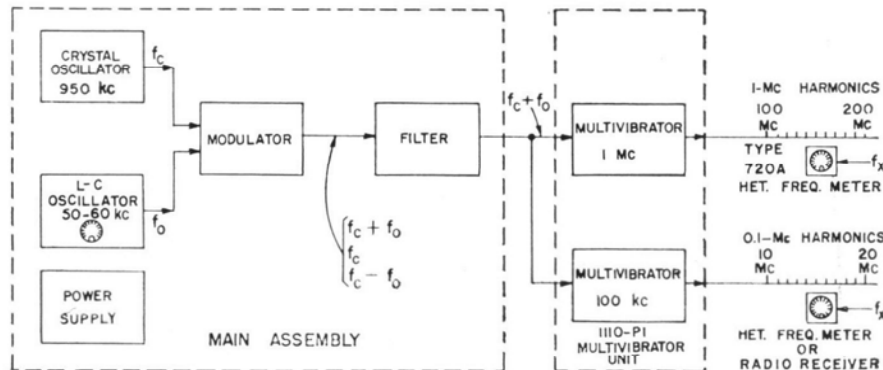



## TYPE 1213-C UNIT TIME/FREQUENCY CALIBRATOR

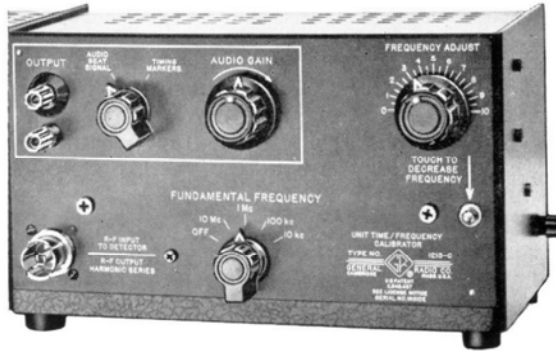

**USES:** The TYPE 1213-C Time/Frequency Calibrator is a compact, inexpensive, secondary standard of frequency containing in a single package the circuits necessary for calibration operations that have hitherto required several instruments. These circuits include: (1) a crystal-controlled source of harmonics at multiples of 10 Mc, 1 Mc, 100 kc and 10 kc, (2) a heterodyne detector and beat amplifier, and (3) a pulse amplifier.

The standard-frequency harmonics are useful for receiver calibration and frequency measurement with external detectors and interpolating equipment. The self-contained mixer and audio amplifier permit calibration of oscillators without requiring any additional equipment.

Separate binding posts on the front panel make available the output signals from the cathode-follower pulse amplifier for use in oscilloscopic time calibration or pulse trigger

applications. The output can be differentiated in the TYPE 1213-P1 Differentiator to provide short pulses at intervals of 0.1  $\mu$ sec, 1.0  $\mu$ sec, 10  $\mu$ sec and 100  $\mu$ sec. The amplitude of the pulses is sufficient to trigger pulse-generating equipment and oscilloscope sweeps.

**DESCRIPTION:** The crystal oscillator uses a 5-Mc AT-cut, hermetically-sealed quartz plate and is electron coupled to a 2:1 multiplier, followed by a buffer stage. The 10-Mc buffer drives a series of multivibrators with fundamentals of 1 Mc, 100 kc, and 10 Kc. Their outputs can be switched to drive either a harmonic generator or video amplifier. The harmonic generator feeds a crystal mixer and an r-f output connector. For harmonic calibration with the mixer, the video amplifier is switched to act as a high-gain audio amplifier at the mixer output. For oscilloscopic time calibration, the video amplifier supplies pulses at binding-post terminals.

A narrow-range frequency adjustment is provided for setting the crystal oscillator to zero beat with standard-frequency radio transmissions or other external standards. A touch-button deviator is provided to introduce a small frequency decrease for establishing "sense" in indications near zero-beat.

- FEATURES:**
- Wide range of output frequencies.
  - Accurate timing source for oscilloscopes.
  - Compact unit construction.
  - Internal mixer for maximum utility.

### SPECIFICATIONS

**Output Frequencies:** 10 Mc, 1 Mc, 100 kc, 10 kc.  
**Output Amplitudes:** 10 Mc, 10v peak-to-peak, 30 volts peak-to-peak at lower output frequencies from pulse amplifier; r-f harmonics usable to 1000 Mc from 10-Mc output, to 500 Mc from 1-Mc output, to 100 Mc from 100-Kc output, and to 10 Mc from 10-kc output.  
**Output Impedance:** Video cathode-follower 300 ohms; r-f output obtained from crystal-diode harmonic generator.  
**Stability:** After 1 hour warm-up, drift rate with regulated plate supply is mainly the drift rate of the quartz crystal (approx 1 ppm/°C). With unregulated power supply, an additional variation of  $\pm 1/2$  ppm with line voltage change from 105 to 125 volts.  
**Sensitivity:** Usable beat notes can be produced with 50

millivolts signal input to mixer over the harmonic ranges specified under "Output Amplitudes."  
**Tube Complement:** 1-6BE6, 1-5687, 2-5964, 1 6AK6, 1-6AN8, 1-5U8.  
**Power Supply:** 6.3 v a-c, 3.0 amps; 300 v d-c, 60 ma. TYPE 1203-A or TYPE 1201-A is recommended. See pages 144 and 145.  
**Accessories Supplied:** TYPE 1213-P1 Differentiator, one coaxial connector, and one multipoint connector.  
**Mounting:** Aluminum panel and sides, finished in black crackle; aluminum cover, finished in clear lacquer. Relay rack panel is available for mounting both calibrator and power supply.  
**Dimensions:** 10 1/2 (width) x 5 3/4 (height) x 7 (depth) inches, overall. **Net Weight:** 4 lbs, 10 oz.

Type		Code Word	Price
1213-C	Unit Time/Frequency Calibrator *.....	REBEL	\$195.00
1203-A	Unit Power Supply.....	ALIVE	40.00
1201-A	Unit Regulated Power Supply.....	ASSET	80.00
480-P4U3	Relay-rack panel (for mounting both calibrator and power supply).....	UNIPANCART	10.00

PATENT NOTICE. See Notes 1, 2, 4, and 5 page viii.



## TYPE 1176-A FREQUENCY METER

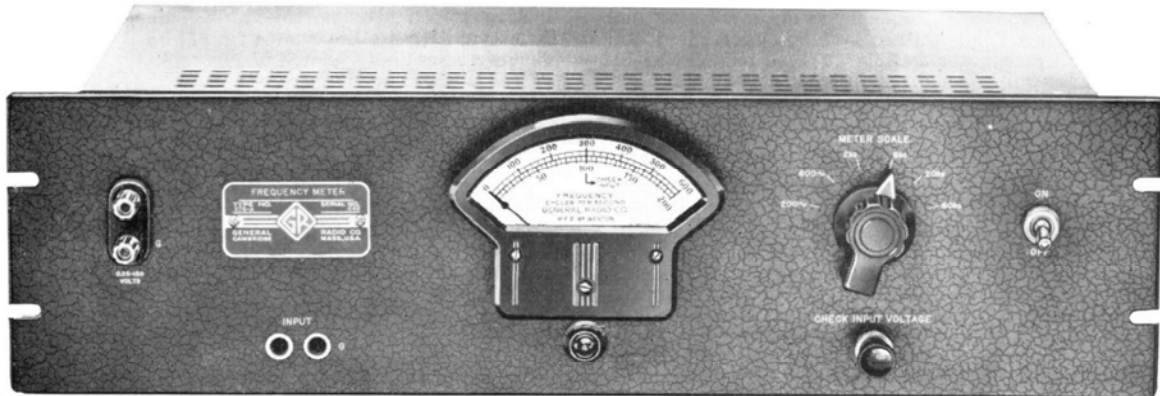

**USES:** The TYPE 1176-A Frequency Meter is a direct-indicating counting-rate type of frequency meter for determining the frequency of an unknown source or continuously monitoring the frequency of a system.

For the electronics laboratory it provides a convenient means of measuring audio and supersonic frequencies up to 60 kc, essentially independent of waveform.

**DESCRIPTION:** The circuit consists of (1) an input amplifier followed by (2) a series of clipping and limiting amplifiers, and (3) a frequency-indicating circuit composed of a capacitor, a diode, and a d-c microammeter. The function of the clippers and limiters is to convert the input signal to a square waveform so that the indication is not affected by changes in amplitude or waveform of the input signal.

**FEATURES:** ➤ Direct-reading scales, and a single range-selector switch, permit rapid frequency measurements to be made.

➤ A well-regulated power supply eliminates all effects of line voltage changes.

➤ Individual scale calibration adjustments are provided for each range.

➤ An external meter can be connected to the instrument through a multipoint connector on the rear of the unit.

➤ Two sets of input terminals are provided on the panel and, on the rear of the unit, a multipoint connector provides a means of attaching more permanent connections. Plugging into the W. E. panel jacks automatically disconnects the rear terminals.

### SPECIFICATIONS

**Range:** 25-60,000 cycles per second in six ranges. Full-scale values are 200, 600, 2000, 6000, 20,000, 60,000 cycles.

**Accuracy:**  $\pm(2\%$  of full scale + 2 cycles), for all ranges. When operating on the 60,000-cycle range, with less than 0.5 volt input, the accuracy becomes  $\pm 3\%$  of full scale.

**Input Voltages:** 0.25-150 volts.

**Input Resistance:** 500,000 ohms, for all ranges. One side grounded.

**Input Waveform:** The readings are substantially independent of waveform, so long as the dissymmetry of the positive and negative portions of the wave is less than 8:1.

**Power Supply:** 105-125 (or 210 to 250) volts, 50-60 cycles.

**Power Input:** 50 watts.

**Tube Complement:**

- 1-6H6
- 1-6SQ7-GT
- 1-6X5-GT
- 1-6V6-GT
- 1-6SN7-G7
- 1-6J5-GT
- 2-6SJ7
- 1-0A3

1—Amperite 3-4D

**Mounting:** Standard 19-inch relay-rack panel; aluminum end frames are available to convert to table mounting. (See price list below.)

**Panel Finish:** Standard General Radio black crackle. Certain standard grays which can be processed in quantity can also be supplied.

**Accessories Supplied:** TYPE ZCAP-5 Power Cord and multipoint connector; spare fuses.

**Dimensions:** Panel, 19 x 5 1/4 inches; depth behind panel, 11 1/4 inches.

**Net Weight:** 19 1/2 pounds.

Type	Code Word	Price
1176-A FRI-310	TIMID	\$285.00
Frequency Meter.....	ENDFRAMCAT	12.00 Pair
End Frames for Type 1176-A.....		

PATENT NOTICE. See Notes 2, 16, page viii.

# STANDARD-SIGNAL GENERATORS

A standard-signal generator is a source of alternating-current energy of accurately known characteristics. The carrier or center frequency is indicated by a dial setting, the output voltage by a meter reading and associated attenuator setting, and the modulation by a meter reading set by appropriate control knobs. Common types of modulation signals are sine-wave, square-wave and pulse; the output signal may be either frequency- or amplitude-modulated by these signals. When the f-m modulating system produces a considerable excursion in frequency at a relatively low cyclical rate, the instrument is known as a sweep generator and is particularly useful for automatic data display. Standard-signal generators are used for testing radio receivers, as voltage standards over the range from a few microvolts to about a volt, and generally for measuring gain, bandwidth, signal-to-noise ratios, standing-wave ratios, and other properties of electronic circuits.

The elements of a standard-signal generator are shown in Figure 1. A buffer amplifier is sometimes added to reduce incidental frequency modulation. The requirements for the oscillator are that it be stable, that it have reasonably constant output over any one frequency range, that the waveform be good, and that hum and noise modulation be negligible.

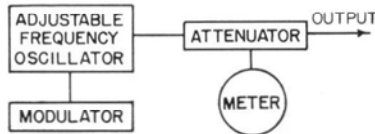

FIGURE 1. Elements of a standard-signal generator.

## OUTPUT SYSTEMS

The output system must be designed to produce a known voltage at the output terminals. At frequencies below 50 Mc, resistive attenuators are commonly used. A voltmeter indicates the voltage at the attenuator input, which is held to a constant "calibration" value by manual adjustment of oscillator-output level. The output voltage is then indicated by the voltmeter indication and the attenuator setting. According to Thévenin's theorem, the generator can be represented as a voltage source behind — i.e., in series with — an impedance. This equivalent voltage is the open-circuit voltage of the signal generator, and the equivalent impedance is that seen looking into the system with the terminals at which the voltage is measured short circuited. For low-frequency generators, the equivalent source impedance is usually made as low as possible, 10 ohms or less.

At low and medium frequencies, with a 10-ohm output impedance, it is frequently possible to neglect the effect of the load on the output voltage and to assume that the terminal voltage is the open-circuit voltage. In any case, the correction for the load can be determined by calculation as indicated in Figure 2.

The effect upon the output voltage and output im-

FIGURE 2. Load voltage  $E_L$  is easily determined for a load  $Z_L$  with a generator of internal voltage  $E_s$  and internal impedance  $Z_s$ .

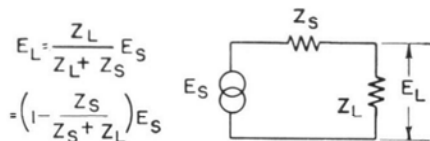

pedance of the cable used to connect the generator to the load depends upon the frequency and upon the relative impedances of generator, cable, and load. Four typical cases are shown in Figure 3, and their characteristics are tabulated in Figure 4.

Case I corresponds to the TYPE 805-C Standard-Signal Generator when the termination unit is used, and to the TYPE 1001-A Standard-Signal Generator when the TYPE 1000-P1 Termination Unit and the TYPE 1000-P2 40-Ohm Series Unit are used.

Case II corresponds to the TYPE 805-C without the termination unit and to the TYPE 1001-A with the series unit but without the termination unit.

Case III illustrates the TYPE 1001-A with termination unit, but without series unit, while Case IV is the TYPE 1001-A without either unit.

When an external load is connected, the load voltage will differ from the open-circuit voltage at the end of the cable by an amount depending upon the magnitude and phase of the load impedance.

At high frequencies the residual reactance in a resistive attenuator becomes great enough to impair its accuracy, and the mutual-inductance (waveguide-below-cutoff) type is more satisfactory. The system used in the TYPE 1021-A Standard-Signal Generator, and which is illustrated in Figure 5, has the voltmeter connected across the output of the attenuator rather than across the input. This system has the advantage that the accuracy of the output voltage at the reference point is determined by the voltmeter alone, and is unaffected by the length of the cable from the attenuator pick-up loop to the point at which the termination at this point. The accuracy of the effective output impedance is determined by the resistor  $R_1$  alone, because it is immediately preceded by the voltmeter, which can be considered a zero-impedance source. This makes the output system equivalent to that shown in Case II, Figure 3. Resistor  $R_2$  at the attenuator pick-up loop is a matching resistance to prevent high-amplitude standing waves in the cable when the load is removed.

Volts between 0.5 volt and 2 volts are indicated directly by the output meter. For voltages below 0.5 volt, the output is first set to 0.5 volt as indicated by

FIGURE 3. Schematic diagrams of four types of generator output system.

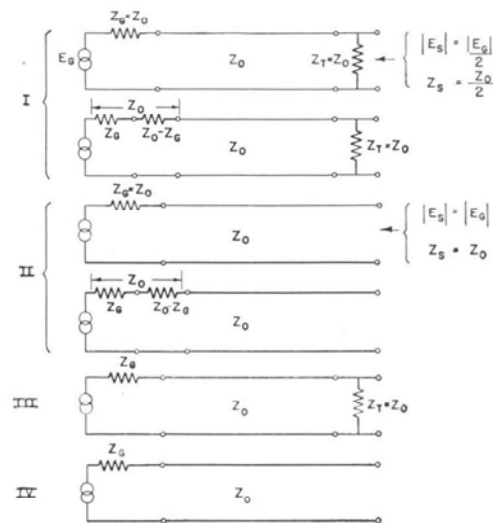

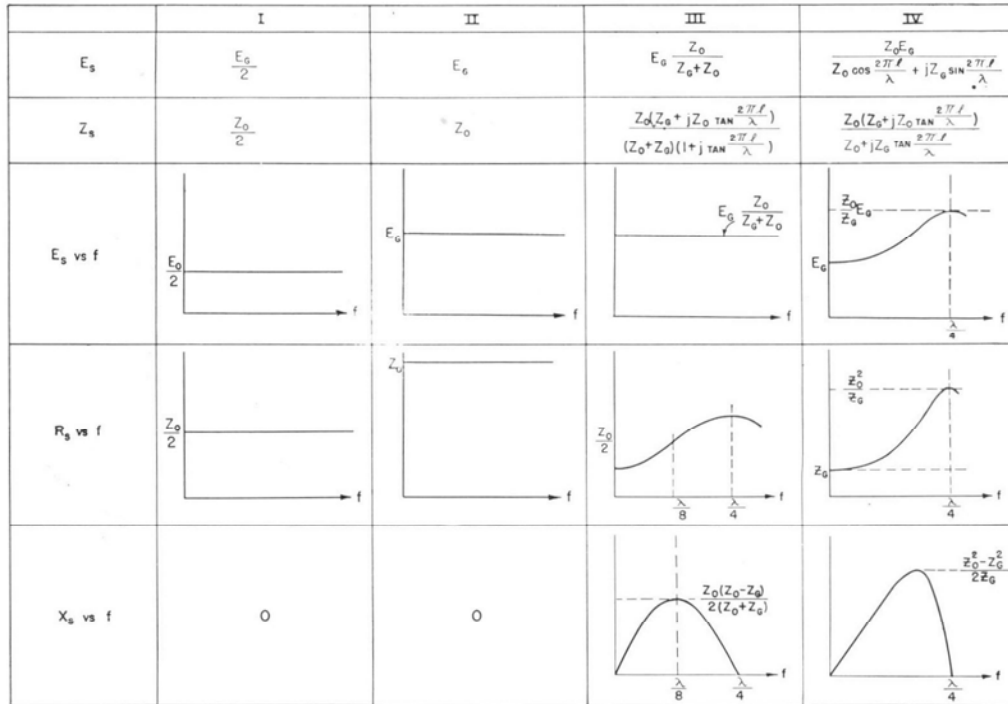

FIGURE 4. Summary of impedance and voltage characteristics of the four types of terminations shown in Figure 3. The relative phase relationships of the voltages are not included, and it is assumed that  $Z_G$  is a pure resistance.

the meter and the attenuator index, which is adjustable, is set at the 0.5-volt point on the attenuator dial. Lower voltages are then indicated directly on the attenuator dial, so long as the load is not changed. When the load is changed, the attenuator must be standardized again at 0.5 volt for the new load.

For ultra-high frequencies, this system gives more accurate output indications than the more common arrangement with the voltmeter at the attenuator input.

**MODULATION**

Internal amplitude modulation at one or more fixed frequencies is provided on all General Radio Signal Generators. Provision is also made for modulation over the entire audio range by an external source.

The TYPE 1001-A Standard-Signal Generator is capable of being modulated up to 80%, the TYPE 805-C up to 100%, and the TYPE 1021-A up to 50%. Some frequency modulation is present in all these signal generators. It is most noticeable in the 1021-A, where the modulation voltage is superimposed on the plate voltage of the oscillator tube. The two lower-frequency signal generators use amplifiers between the oscillator and the output circuit. They are modulated in the amplifier stage, and their incidental frequency modulation is low enough to be of no consequence in most measurements.

For measurements where incidental frequency modulation must be kept at a minimum, and also where amplitude modulation at video frequency is desired, the unmodulated and attenuated output of the signal generator can be modulated by the external TYPE 1000-P6 Crystal Diode Modulator. This modulator is a small, inexpensive unit, described in detail on page 99. It consists of a crystal diode between input and output terminals and provides means for applying bias and modulating voltages to the crystal. It can be used at

carrier frequencies between 20 and 1000 megacycles and can produce up to 30% amplitude modulation from 0 to 5 megacycles. The output of the TYPE 1000-P6 Crystal Diode Modulator is limited to approximately 10 millivolts.

The TYPE 1000-P7 Balanced Modulator, described in detail on page 100, is another external modulating unit for use with signal generators and oscillators. It consists of two crystal diodes, a tunable section of coaxial line between input and output terminals, and some associated circuits for applying bias and modulating voltages. It is designed for use at carrier frequencies from 60 to 2300 megacycles and can produce up to 100% amplitude modulation from either sine-wave or pulse sources.

FIGURE 5. Functional diagram of the TYPE 1021-A output system.

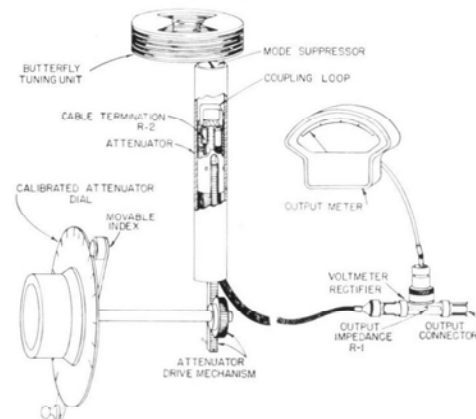

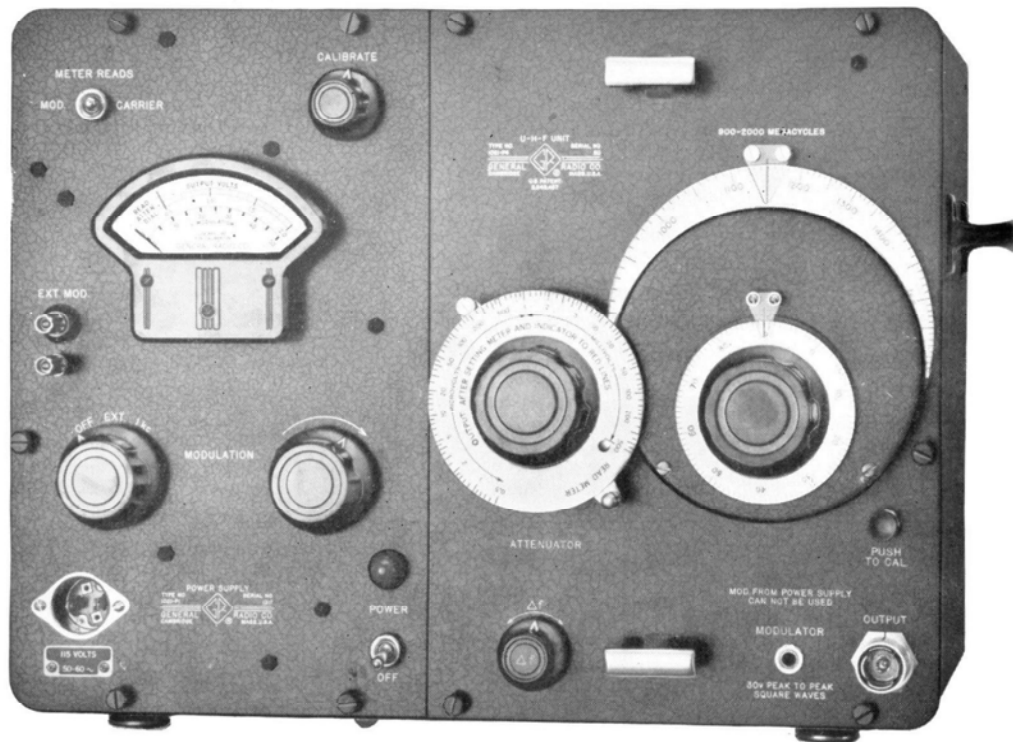

## TYPE 1021 STANDARD-SIGNAL GENERATORS

### 40 TO 2000 MEGACYCLES IN THREE MODELS

**USES:** These Standard-Signal Generators are as reliable and as convenient at very-high and ultra-high frequencies as conventional standard-signal generators at much lower frequencies. Their uses include the determination of radio-receiver and amplifier characteristics in the engineering laboratory and in production as well as the supply of v-h-f and u-h-f power for bridges, slotted lines, and other measuring devices.

The simple TYPE 1000-P6 Crystal-Diode Modulator and a source of video signals, such as a standard television receiver tuned to a local television station, can be used to produce television picture modulation of the signal generator output on all v-h-f and u-h-f channels.

With the TYPE 1000-P7 Balanced Modulator, up to 100% amplitude modulation and pulsing with very low residual carrier level are possible.

**DESCRIPTION:** Each TYPE 1021 Standard-Signal Generator is a compact and light-weight instrument of simple, rugged, durable design. For flexibility and economy, each signal generator is made up of two units mounted in a

single cabinet. The power supply, modulator, and metering system make up one unit, the TYPE 1021-P1 Power Supply, which occupies the left-hand side of the welded aluminum cabinet. The right-hand side of the cabinet houses one of the three readily interchangeable carrier-oscillator units: The TYPE 1021-P2 U-H-F Unit (250 to 920 Mc.) the TYPE 1021-P3B/V-H-F Unit (40 to 250 Mc.) or the TYPE 1021-P4 U-H-F Unit (900 to 2000 Mc.)

As noted in the price table, individual tuning units can be furnished for use with one common power supply and cabinet assembly.

The two lower-frequency generators have provisions for external and 1000-cycle sine-wave internal amplitude modulation; the 900 to 2000 Mc unit can be modulated by square waves from the TYPE 1210-B Unit R-C Oscillator.

The two lower-frequency models use butterfly circuits, and the highest frequency model is tuned by adjustable transmission lines. A mutual-inductance-type attenuator with a dial calibrated from 0.5  $\mu$ v to 0.5 volt is used for all the oscillators. Voltages over 0.5 volt are read directly on the panel meter.





**FEATURES:** ➤ Wide frequency coverage.  
 ➤ Easy to operate.  
 ➤ Up to one volt output.  
 ➤ Accurately known output voltage, frequency, and impedance.

➤ Good stability and low drift.  
 ➤ Very well shielded.  
 ➤ A wide variety of coaxial accessories is available (see pages 52 to 62).  
 ➤ Three carrier-oscillator units easily interchangeable.

## SPECIFICATIONS

### TYPE 1021-AU U-H-F STANDARD-SIGNAL GENERATOR

**Carrier Frequency Range:** 250 Mc to 920 Mc in one band.  
**Frequency Calibration:** Direct reading to  $\pm 1\%$ .  
**Output Voltage:** Continuously adjustable from 0.5  $\mu\text{v}$  to 1.0 volt, open-circuit.  
**Output Impedance:** 50 ohms  $\pm 10\%$ .  
**Output Voltage Accuracy:** Over-all accuracy of output voltage is better than  $\pm 20\%$ . The accuracy of output voltmeter calibration between 0.5 volt and 1.0 volt is better than  $\pm 10\%$ . The accuracy of the attenuator dial calibration for voltages between 1.0  $\mu\text{v}$  and 0.1 volt is better than  $\pm 5\%$ ; from 0.1 volt to 0.5 volt, better than  $\pm 10\%$ . At 920 Mc, the resonance error in the voltmeter is  $\pm 6\%$ .  
**Amplitude Modulation:** Adjustable, 0 to 50%. Internal, 1000 c  $\pm 5\%$ . External, flat within 3 db from 30 c to 15 kc. For 50% modulation, external audio oscillator must supply 18 volts across a 100-kilohm load. TYPE 1210-B Unit R-C Oscillator is recommended.  
**Envelope Distortion:** Less than 5% at 50% modulation.  
**Noise Level:** Carrier noise level corresponds to about 0.2% modulation.  
**Incidental Frequency Modulation:** For 50% amplitude modulation the incidental fm is approximately 100 parts per million for frequencies up to 400 Mc and is approximately 1000 parts per million at 920 Mc. When lower values of incidental fm are required, the TYPE

1000-P6 Crystal Modulator, or the TYPE 1000-P7 Balanced Modulator (pages 99 and 100) is recommended.  
**Leakage:** Stray fields and residual output voltage are sufficiently low for measurements on receivers of one-microvolt sensitivity.  
**Terminals:** TYPE 874 Coaxial Terminals are provided for the output connection.  
**Power Supply:** 115 or 230 volts, 50 to 60 cycles. Power input is approximately 50 watts.  
**Tube Complement:** Two 0C3; one each, 6X5-GT/G, 6K6-GT, Sylvania TYPE RT-434, Amperite 6-4.  
**Accessories Supplied:** TYPE 874-R22 Patch Cord, TYPE 874-PB58 Panel Connector, TYPE 874-C58 Cable Connector, TYPE CAP-35 Power Cord, and spare fuses.  
**Other Accessories Available:** TYPE 874-G10 and -G20 Fixed Attenuators, TYPE 874 Coaxial Elements (page 52 to 62), TYPE 1000-P6 Crystal Modulator, TYPE 1000-P7 Balanced Modulator (pages 99 and 100).  
**Mounting:** The aluminum cabinet has a black wrinkle finish. The left-hand side houses the TYPE 1021-P1 Power Supply; the right-hand side houses the TYPE 1021-P2 U-H-F Unit. Panels are black crackle-finished aluminum.  
**Dimensions:** (Height)  $14\frac{3}{8}$  x (width)  $20\frac{1}{4}$  x (depth)  $10\frac{9}{16}$  inches, over-all.  
**Net Weight:**  $37\frac{1}{2}$  pounds.

### TYPE 1021-AV V-H-F STANDARD-SIGNAL GENERATOR

Same as TYPE 1021-AU (above) except as noted.  
**Carrier Frequency Range:** 40 to 50 Mc in one band, 50-250 in another.  
**Incidental Frequency Modulation:** For 50% amplitude modulation the incidental fm is approximately 100 parts per million for frequencies up to 100 Mc, and is approximately 500 parts per million at 250 Mc. When lower values of incidental fm are required, the TYPE

1000-P6 Crystal Modulator or the TYPE 1000-P7 Balanced Modulator (page 100) is recommended.  
**Tube Complement:** 12AT7 (Oscillator instead of RT-434). Other tubes as listed above.  
**Mounting:** Cabinet is same as for TYPE 1021-AU, above. Generator consists of the TYPE 1021-P1 Power Supply and TYPE 1021-P3B V-H-F Unit.

### TYPE 1021-AW U-H-F STANDARD-SIGNAL GENERATOR

Same as TYPE 1021-AU (above) except as noted.  
**Carrier Frequency Range:** 900 to 2000 Mc in one band.  
**Output Voltage:** 0.7 volt maximum over entire range.  
**Output Voltage Accuracy:** Same as TYPE 1021-AU except resonance error in voltmeter is compensated.  
**Amplitude Modulation:** Square-wave modulation from 100 to 5,000 cycles with external modulator. 30 volts peak-to-peak is required. 2500-ohm input impedance. TYPE 1210-B Unit Oscillator is recommended.

**Tube Complement:** TYPE 5675 oscillator instead of TYPE RT-434. Other tubes as listed above.  
**Accessories Supplied:** Same as above plus one telephone plug.  
**Accessories Available:** TYPE 874 Coaxial Elements pages 52 to 62; TYPE 1000-P7 Balanced Modulator, page 100.  
**Mounting:** Cabinet is same as for TYPE 1021-AU, above. Generator consists of the TYPE 1021-P1 Power Supply and TYPE 1021-P4 U-H-F Unit.

Type		Code Word	Price
1021-AU	U-H-F Standard-Signal Generator, 250-920 Mc.....	EVADE	\$640.00
1021-AV	V-H-F Standard-Signal Generator, 40-250 Mc.....	EVENT	640.00
1021-AW	U-H-F Standard-Signal Generator, 900-2000 Mc.....	EAGLE	890.00
1021-P2	U-H-F Oscillator Unit * only, 250-920 Mc.....	ETHIC	400.00
1021-P3B	V-H-F Oscillator Unit * only, 40-250 Mc.....	EVOKE	400.00
1021-P4	U-H-F Oscillator Unit * only, 900-2000 Mc.....	EXALT	650.00

PATENT NOTICE. See Notes 4 and 10, page viii.

\* Less power supply unit and cabinet. Can replace oscillator unit in any signal generator listed above, to provide additional frequency range.

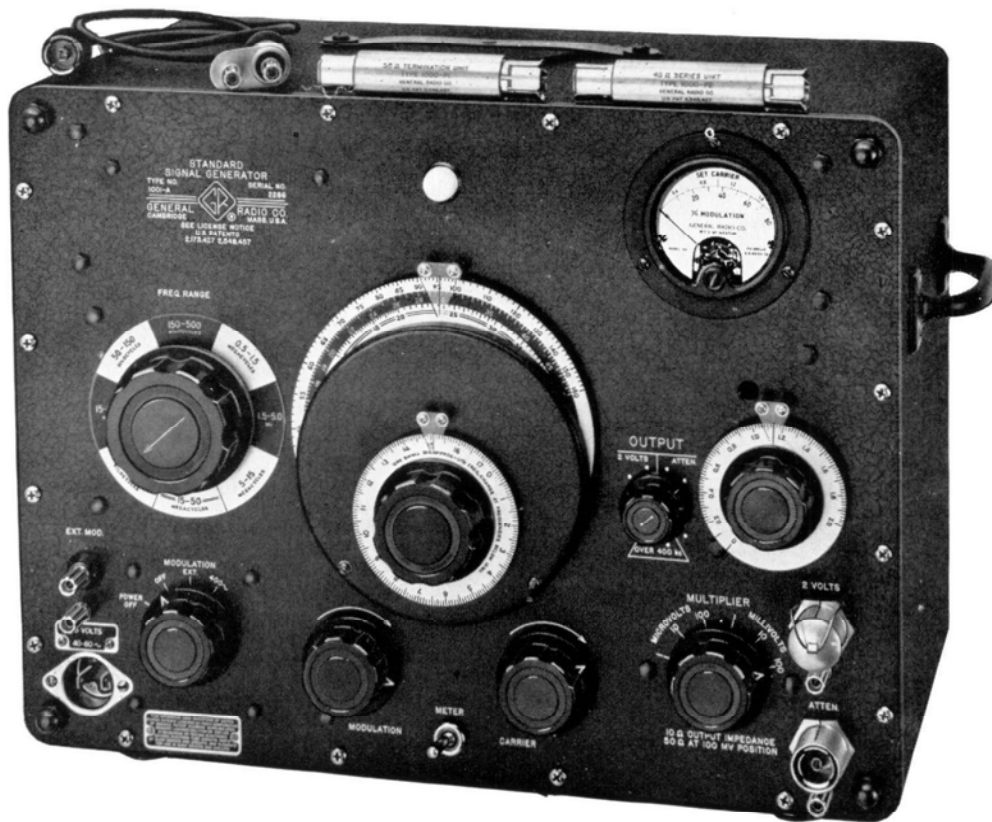

## TYPE 1001-A STANDARD-SIGNAL GENERATOR

**USES:** The TYPE 1001-A Standard-Signal Generator is a laboratory instrument for use in determining the performance of receivers and other equipment at ultrasonic and radio frequencies. Its sturdy construction and simplicity of operation make it suitable for production testing. Because of its small size, low weight, and low power consumption, it can be adapted for use in field-strength measurements.

With the TYPE 1000-P6 Crystal Diode Modulator, the generator output can be modulated at video frequencies for testing television i-f circuits.

**DESCRIPTION:** The welded aluminum cabinet of the TYPE 1001-A Standard-Signal Generator houses three separate groups of circuits. The power supply is at the top, the completely shielded radio-frequency portion in the middle, and the modulation and control circuits at the bottom.

The Hartley-type carrier-frequency oscillator covers in eight ranges the frequency spectrum from 5 kc to 50 Mc. The plates of the main tuning capacitor are shaped to give a

logarithmic variation of frequency with angular rotation. The precision of frequency setting, therefore, is constant, and the vernier dial is calibrated directly in percentage frequency increments.

A buffer amplifier is used between the oscillator and the low-impedance output circuits. The amplifier is grid modulated to provide amplitude modulation from 0 to 80 percent. Loose coupling between the oscillator and the amplifier minimizes incidental frequency modulation. The attenuator system and the output meter are coupled to the amplifier through a high-pass filter, which reduces voltages of the modulation frequency in the output.

The output voltage is determined by establishing a fixed carrier level at the attenuator input and by setting two attenuator controls. The carrier level is set by adjusting the plate-supply voltage of the oscillator and is indicated by a vacuum-tube voltmeter at the attenuator input. The attenuator system consists of a continuously adjustable L-network controlled by the output dial and a decade ladder-network attenuator.



The modulation circuits include a 400-cycle R-C oscillator for internal modulation and a germanium-crystal rectifier to determine modulation percentage. Percentage modulation is read on the same panel meter that indicates the carrier output level.

**FEATURES:** ▶ Output cable termination can be removed for matching into a 50-ohm system.

- ▶ Very low residual output and stray field.
- ▶ A periodic output amplifier avoids sideband cutting and minimizes reaction of attenuator setting or load on carrier frequency.
- ▶ High stability and low drift are assured by high-quality components, low power consumption, and stabilized power supply.
- ▶ Simplicity of design and construction has resulted in an unusually sturdy instrument of small size, low weight, and long life.

### SPECIFICATIONS

**Carrier-Frequency Range:** 5 kilocycles to 50 megacycles covered in eight direct-reading ranges: 5 to 15 kc, 15 to 50 kc, 50 to 150 kc, 150 to 500 kc, 0.5 to 1.5 Mc, 1.5 to 5 Mc, 5 to 15 Mc, and 15 to 50 Mc.

**Frequency Calibration:** Logarithmic up to 15 Mc, departing slightly from the logarithmic scale at higher frequencies. Accuracy,  $\pm 1\%$ .

**Incremental-Frequency Dial:** Frequency increment is 0.1% per dial division, at frequencies up to 15 Mc.

**Frequency Stability:** Warm-up drift is of the order of 0.25%. Half the maximum drift is reached in  $1\frac{1}{2}$  hours.

**Output Voltage Range:** Open-circuit output voltage at the attenuator jack is continuously adjustable from 0.1 microvolt to 200 millivolts. With output cable terminated at both ends, output voltage is continuously adjustable from 0.05 microvolt to 100 millivolts. Open-circuit output voltage at the 2 VOLTS panel jack is measured directly by the output meter and is 2 volts if the meter is set to the reference mark. This voltage is available up to at least 15 Mc.

**Output Impedance:** Output impedance at the attenuator jack is 10 ohms (50 ohms when the series unit is used) except for the highest output position of the attenuator, where it is 50 ohms.

Output impedance at the end of the terminated cable is 25 ohms. Output impedance at the 2 VOLTS panel jack is 300 ohms.

An output impedance of one ohm (with output voltage reduced 100:1) can be obtained with the TYPE 1000-P3 Voltage Divider, a standard (IRE) test impedance with the TYPE 1000-P4 Dummy Antenna, and a known induction field for testing loop receivers with the TYPE 1000-P10 Test Loop.

**Accuracy of Output Voltages:** At frequencies below 10 Mc, when the output dial is set near full scale or one-tenth full scale, the output voltage is correctly indicated to  $\pm(6\% + 0.1 \mu\text{v})$ . With the output dial set in the mid-scale region, the error may be greater by 4%. At frequencies above 10 Mc, when the output dial is set near full scale, the output voltage is correctly indicated to an accuracy of  $\pm(10\% + 0.3 \mu\text{v})$  and the error may be as much as 10% larger or smaller at other output dial settings.

The accuracy of the open-circuit output voltages at the 2 VOLTS panel jack is  $\pm 3\%$  up to 15 megacycles.

**Amplitude Modulation:** Adjustable from zero to 80%. Modulation percentage is indicated on the panel meter and is accurate within  $\pm 10\%$  of the indicated value, with a possible additional error of 2% in modulation level.

The internal modulation frequency is 400 cycles  $\pm 5\%$ .

The external modulation characteristic is flat within  $\pm 1$  decibel from 20 cycles to 15 kilocycles. To provide

80% modulation, the external audio oscillator must supply 12 volts into a 4000-ohm load (36 milliwatts).

**Incidental Frequency Modulation:** At 80% amplitude modulation, the incidental frequency modulation varies from 30 to 300 parts per million over each carrier-frequency range except for the highest frequency range (15 to 50 Mc) where it may be three times as great. At lower modulation percentages, frequency modulation is approximately proportional to modulation percentage.

For applications above 20 Mc, where incidental frequency modulation must be very low, the use of the TYPE 1000-P6 Crystal Diode Modulator (page 99) is recommended.

**Carrier Distortion:** Of the order of 7% on all except the lowest range, where it may increase to 15%.

**Envelope Distortion:** Less than 8% at 80% amplitude modulation.

**Noise Level:** Carrier noise level corresponds to about 0.1% modulation.

**Leakage:** Stray fields at 1 Mc are less than one microvolt per meter two feet from the generator.

**Terminals:** TYPE 874 Coaxial Terminals are provided for the attenuator output and for the constant 2-volt output.

**Power Supply:** 105 to 125 (or 210 to 250) volts, 40 to 60 cycles. Power input is approximately 65 watts at 115 volts.

**Tube Complement:**

1 — 6C4	1 — 5Y3-GT
1 — 6L6	2 — 0C3
1 — 6AL5	1 — 6SN7-GT

**Accessories Supplied:** TYPE 874-R22 3-foot Coaxial Cable, TYPE 1000-P1 50-Ohm Termination Unit, TYPE 1000-P2 40-Ohm Series Unit, TYPE 874-Q2 Adaptor, TYPE TO-44 Adjustment Tool (stored in cabinet), TYPE 274-MB Plug, TYPE 874-C58 Cable Connector, TYPE 874-PB58 Panel Connector, spare fuses, and a TYPE CAP-35 Power Cord.

**Other Accessories Available:** Not supplied but available on order are the TYPE 1000-P3 Voltage Divider, the TYPE 1000-P4 Standard Dummy Antenna, the TYPE 1000-P10 Test Loop, and the TYPE 1000-P 6 Crystal Diode Modulator. See pages 102 and 103.

**Mounting:** The instrument is assembled on an aluminum panel finished in black crackle lacquer and mounted in an aluminum cabinet with a black wrinkle finish. The cabinet is provided with carrying handles. A recessed compartment is built into the top of the cabinet for storing accessories.

**Dimensions:** (Height)  $14\frac{3}{8}$  x (width)  $20\frac{1}{4}$  x (depth)  $10\frac{3}{16}$  inches, over-all.

**Net Weight:** 54 pounds.

Type	Code Word	Price
1001-A   Standard-Signal Generator.....	ARGUS	\$795.00

PATENT NOTICE. See Notes 2, 4, and 9, page viii.

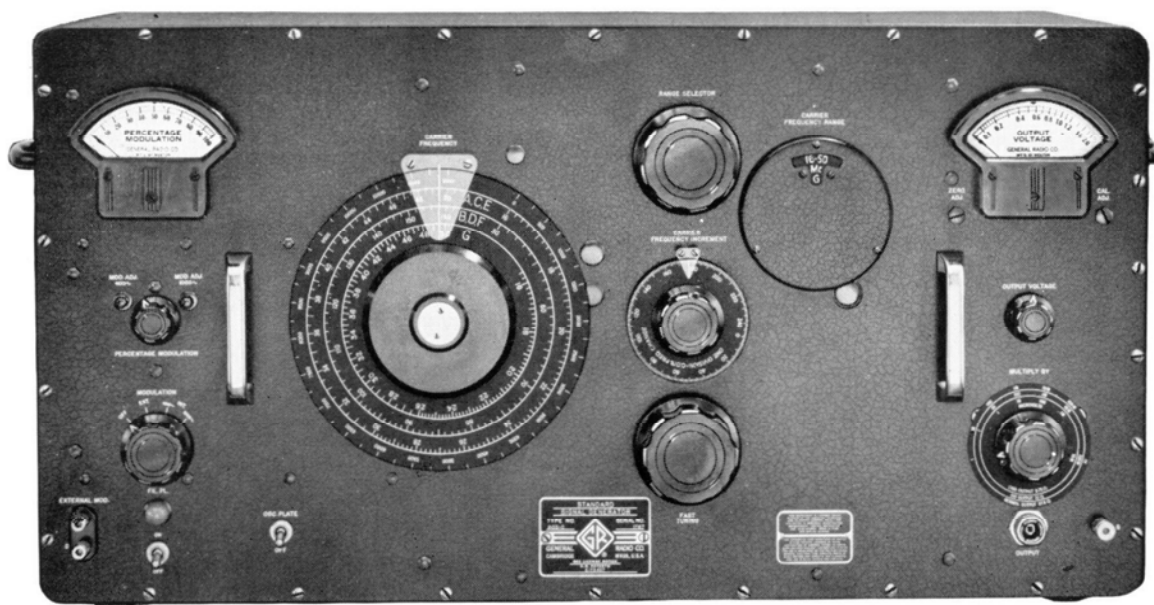

## TYPE 805-C STANDARD-SIGNAL GENERATOR

**USES:** The TYPE 805-C Standard-Signal Generator is designed primarily as a precision laboratory instrument for rapid and accurate testing of radio receivers. Because of its accuracy, wide frequency range, and high voltage output, it is a valuable instrument for laboratories engaged in research and design on radio receivers and allied apparatus, while its speed and simplicity of operation make it well adapted to production testing.

It can be adapted for testing television i-f circuits by the use of a TYPE 1000-P6 Crystal Diode Modulator.

**DESCRIPTION:** Functionally this instrument consists of (1) a carrier-frequency oscillator, (2) a tuned radio-frequency amplifier, (3) a resistive output attenuator and a voltmeter to read the output level, (4) a modulating oscillator (400 cycles and 1000 cycles) with a voltmeter for reading percentage modulation, and (5) a well-regulated power supply.

The oscillator and amplifier assemblies are virtually identical in construction, and the coil switching assemblies, as well as the tuning capacitors, are ganged and driven from common panel controls. Seven coils covering the frequency range from 16 kc to 50 Mc are carried on a selector disc in each assembly. An eighth coil position is also provided, so that an extra set of coils may be installed if desired. The discs are driven from a panel knob through a gear mechanism, which also brings into panel view a frequency-range identification dial. As each coil is rotated into posi-

tion, it is connected into circuit through silver-overlaid contact blades, which firmly engage silver-alloy brushes, mounted on the tuning capacitor. The contacts are mounted on polystyrene strips, insuring both low capacitance and low dielectric losses.

The main tuning capacitors are exceptionally rugged, utilizing the cast frame type of construction, with ball-bearing supports for the rotor. The plates are shaped to give a logarithmic variation of frequency with angular rotation. The two capacitors are driven through a set of gears, which also drive the direct-reading frequency dial.

The output system consists of a vacuum-tube voltmeter, a resistive attenuator network, a 3-foot, 75-ohm output cable, and a terminating unit. This unit terminates the cable in its characteristic impedance. It provides, in addition to the normal output at 37.5 ohms, outputs reduced by factors of 10 and 100, with corresponding output impedances of 7.1 and 0.75 ohms. A standard-broadcast-band dummy-antenna output is also provided.

**FEATURES:** ▶ Output voltage continuously variable up to 2 volts.

▶ Amplitude modulation up to 100%.

▶ Direct-reading incremental-frequency dial with 0.01% frequency change per division.

▶ Simplified controls, well suited to production-line testing by relatively unskilled personnel.



- Tuned amplifier minimizes reaction of output circuit on carrier frequency.
- Tuned circuit is heavily damped to prevent side-band clipping.
- Minimum backlash in gear trains.
- Regulated power supply eliminates the effects of line-voltage fluctuations.

### SPECIFICATIONS

**Carrier Frequency Range:** 16 kilocycles to 50 megacycles, covered in seven direct-reading ranges: 16 to 50 kc, 50 to 160 kc, 160 to 500 kc, 0.5 to 1.6 Mc, 1.6 to 5.0 Mc, 5.0 to 16 Mc, 16 to 50 Mc. A spare range position is provided so that a special set of coils can be installed if desired.

**Frequency Calibration:** Each range is direct reading to an accuracy of  $\pm 1\%$  of the indicated frequency.

**Frequency Drift:** Not greater than  $\pm 0.1\%$  on any frequency range for a period of 5 hours' continuous operation.

**Incremental Frequency Dial:** A slow-motion vernier drive dial is provided, by means of which frequency increments as small as  $0.01\%$  may be obtained.

**Output Voltage Range:** Continuously adjustable from 0.1 microvolt to 2 volts. The output voltage (at the termination of the 75-ohm output cable) is indicated by a panel meter and seven-point multiplier.

**Output System:** The output impedance at the panel jack is 75 ohms, resistive. A 75-ohm output cable is provided, together with a termination unit that furnishes constant output impedances of 37.5, 7.1, and 0.75 ohms. The calibration of the panel voltmeter-multiplier combination is in terms of the actual voltage across the 37.5-ohm output. When the 7.1- and 0.75-ohm positions are used, the indicated output voltage must be divided by 10 and 100, respectively. A standard dummy-antenna output is also available at the termination unit.

**Output Voltage Accuracy:** For multiplier settings below 1 volt the maximum error in output voltage is the sum of the attenuator and voltmeter errors listed below.

**Maximum Voltmeter Error:**  $\pm 5\%$  of indicated reading up to 25 megacycles. Above 25 megacycles, an additional frequency error occurs, amounting to a total of  $\pm 7\%$  at 50 megacycles. At  $\frac{1}{10}$  full scale and 50 Mc, there is also a transit-time error of  $-5\%$  in the voltmeter tube.

**Maximum Attenuator Error:**

- Below 3 Mc,  $\pm (3\% + 0.1 \text{ microvolt})$
- 3 to 10 Mc,  $\pm (5\% + 0.2 \text{ microvolt})$
- 10 to 30 Mc,  $\pm (10\% + 0.4 \text{ microvolt})$
- 30 to 50 Mc,  $\pm (15\% + 0.8 \text{ microvolt})$

There is no attenuator error for the 1-volt multiplier setting.

**Modulation:** Continuously variable from 0 to 100%. The percentage of modulation is indicated by a panel meter to an accuracy of  $\pm 10\%$  of the meter reading up

to 80%, for carrier frequencies below 16 Mc;  $\pm 15\%$  for higher carrier frequencies.

Internal modulation is available at 400 cycles and 1000 cycles, accurate in frequency within  $\pm 5\%$ .

The generator can be modulated by an external oscillator. Approximately 10 volts across 500,000 ohms are required for 80% modulation. The over-all modulation characteristic is as follows:

Carrier Frequency	Audio Range	Level
0.5 — 50 Mc	50c — 15,000c	$\pm 1 \text{ db}$
0.1 — 0.5 Mc	50c — 10,000c	$\pm 1.5 \text{ db}$
16 — 100 kc	50c — 10% of Carrier	$\pm 1.5 \text{ db}$

**Frequency Modulation:** On the highest carrier-frequency range the frequency modulation is about  $0.05\%$  for 100% modulation, and  $0.02\%$  for 30% modulation. At lower carrier frequencies the frequency modulation is less than these percentages.

Above 20 Mc, for applications where incidental fm must be negligible or for wideband (video) modulation, the TYPE 1000-P6 Crystal Diode Modulator should be used.

**Distortion and Noise Level:** The envelope distortion at a modulation level of 80% is less than  $5\%$  at 1 Mc carrier frequency. Carrier noise level is at least 40 db below 80% modulation.

**Leakage:** The magnetic induction leakage is less than 5 microvolts per meter at a distance of 2 feet from the generator. The 3-foot output cable permits the receiver under test to be kept beyond this limit. Radiation fields are negligible.

**Power Supply:** The instrument operates from any 40 to 60 cycle, 115-volt (or 230-volt) line. An electronic voltage regulator compensates for line-voltage fluctuations from 105 to 125 volts (or from 210 to 250 volts). A maximum input power of 150 watts is required.

**Tube Complement:**

1 — 6C8-G	1 — 0D3
3 — 6L6	1 — 6AL5
1 — 5U4-G	1 — 6H6
2 — 2A3	1 — Amperite 3-4
1 — 6SF5	

**Accessories Supplied:** TYPE CAP-35 Power Cord, shielded output cable and termination unit, and spare fuses.

**Mounting:** The panel is finished in black crackle, and the cabinet is black wrinkle finish.

**Dimensions:** (Height) 16 x (width) 33 x (depth) 12 inches, over-all.

**Net Weight:** 117½ pounds.

Type	Code Word	Price
805-C   Standard-Signal Generator.....	LEPER	\$1650.00

PATENT NOTICE. See Notes 1, 2, 4, and 9, page viii.

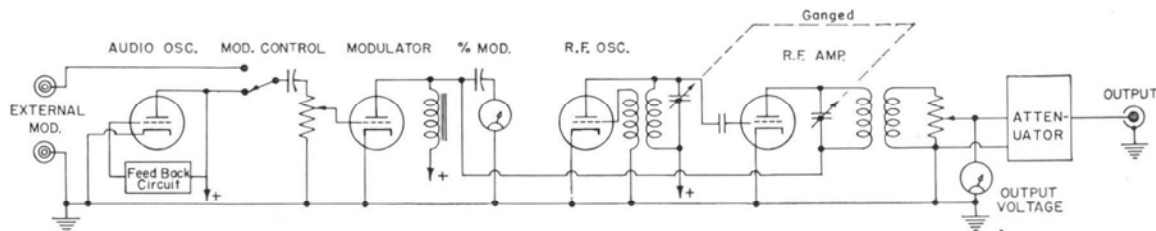



## TYPE 1000-P SIGNAL-GENERATOR ACCESSORIES



View of the TYPE 1000-P10 Test Loop, the TYPE 1000-P3 Voltage Divider, and the TYPE 1000-P4 Standard Dummy Antenna.

### TYPE 1000-P3 VOLTAGE DIVIDER

This voltage divider, used with the TYPE 1001-A Standard-Signal Generator, provides a known voltage across a one-ohm resistor, which can be inserted in series with a loop antenna for testing loop receivers.

It plugs into the output jack of the signal generator (TYPE 1001-A) and divides the indicated output voltage by a factor of 100.

**Input Impedance:** 50 ohms.

**Output Impedance:** 1 ohm.

**Terminals:** TYPE 874 Coaxial Connectors.

**Net Weight:** 3¼ ounces.

Type	Code Word	Price
1000-P3   100:1 Voltage Divider..	ARMOR	\$17.50

PATENT NOTICE. See Note 4, page viii.

### TYPE 1000-P4 DUMMY ANTENNA

Connected to the terminated output of a standard-signal generator of 50-ohm output impedance (25 ohms), this dummy antenna provides the output characteristics specified by the Institute of Radio Engineers in their 1948 "Standards on Radio Receivers, Methods of Testing Amplitude-Modulation Broadcast Receivers." Terminals are TYPE 874 Coaxial Connectors, which fit both the signal generator output jack and the output cable.

**Net Weight:** 3¼ ounces.

Type	Code Word	Price
1000-P4   Dummy Antenna.....	ARROW	\$15.00

PATENT NOTICE. See Note 4, page viii.

### TYPE 1000-P10 TEST LOOP

With this shielded test loop, radio receivers with loop antennas can be tested by the preferred method of the 1948 "Standards on Radio Receivers, Methods of Testing Amplitude-Modulation Broadcast Receivers," published by the Institute of Radio Engineers. The 3-turn loop is inclosed in copper tubing for electrostatic shielding. Circuit constants are chosen to make the field

strength in volts per meter, at a distance of 19 inches from the loop, equal to one-tenth the signal generator output in volts, with a 50-ohm generator.

**Terminal:** TYPE 874 Coaxial Connector.

**Dimensions:** (Height) 16½ x (width) 11¾ x (depth) 3½ inches.

**Net Weight:** 4½ pounds.

Type	Code Word	Price
1000-P10   Shielded Test Loop.....	ARRAY	\$40.00

PATENT NOTICE. See Note 4, page viii.

### TYPE 1000-P5 V-H-F TRANSFORMER

50 Ohms, Grounded, to 300 Ohms, Balanced



The TYPE 1000-P5 V-H-F Transformer is designed to plug into a standard-signal generator having a 50-ohm unbalanced output and to produce an equal, balanced, open-circuit voltage behind a 300-ohm balanced impedance for r-f measurements of f-m and t-v receivers.

The transformer is mounted in a cylindrical container terminated at one end in a TYPE 874 Coaxial

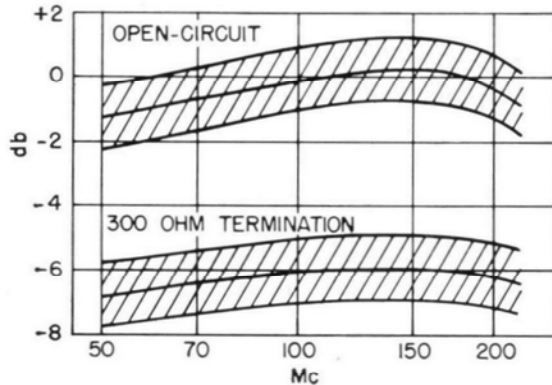

Frequency Characteristics of TYPE 1000-P5 V-H-F Transformer. Shaded areas show tolerances.



Connector and at the other in a socket designed to receive the Alden TYPE HA902P Connector for standard 300-ohm open parallel-wire line.  
**Frequency Range:** 50 Mc to 250 Mc.  
**Frequency Characteristic:** See plot.  
**Input Impedance:** Approximately 300 ohms. Designed to work out of 50-ohm source.

**Terminals:** Input — General Radio TYPE 874 Coaxial Connector.  
 Output — Fits Alden TYPE HA902P Connector; mating connector is furnished.  
**Dimensions:** (Length)  $4\frac{3}{8}$  x (diameter)  $\frac{7}{8}$  inches.  
**Net Weight:**  $3\frac{1}{2}$  ounces.

Type	Code Word	Price
1000-P5   V-H-F Transformer . . . . .	ARSON	\$27.50

PATENT NOTICE. See Note 4, page viii.

**TYPE 1000-P6 CRYSTAL DIODE MODULATOR**

**USES:** The crystal diode modulator is an inexpensive absorption modulator for amplitude modulating the output of a radio-frequency generator over the carrier range from 20 to 1000 megacycles. It can be used to modulate the output of standard-signal generators and other oscillators over a modulating-frequency range of 0 to 5 megacycles. It is particularly useful where wide-band modulation, as for television receiver testing, is required, or for radio receiver tests where incidental fm must be negligible.

**DESCRIPTION:** The modulator consists of a crystal diode between input and output terminals, a simple output filter to prevent appreciable modulating voltage appearing in the output, and a means of isolating and applying modulating and bias voltages. Since the resistance of the crystal diode is a function of the voltage across it, this resistance can be modulated by applying a varying voltage. Inserted between a radio-frequency generator and its load, the unit produces amplitude modulation by variation of series impedance.

When the modulator is used with a standard-signal generator, the output attenuator of the generator provides sufficient isolation to prevent reaction of the modulator on the generator frequency. With an oscillator not equipped with an output attenuator, it is recommended that a TYPE 874-G20 (20 db) or a TYPE 874-G10 (10 db) Attenuator be used.

**FEATURES:** ➤ When used with a standard-signal generator, the crystal diode modulator works on the output side of the attenuator, so that reaction on the oscillator

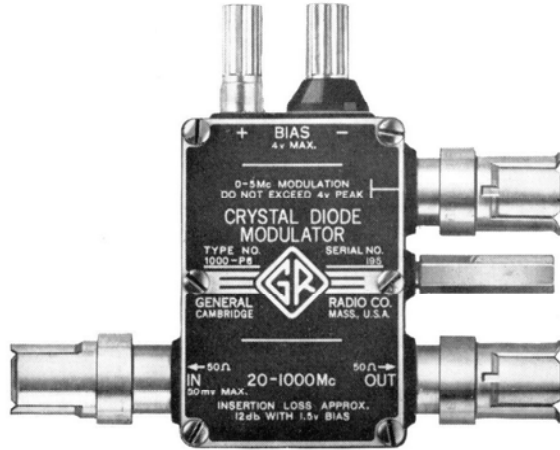

frequency, and hence frequency modulation, is practically negligible. The power required for modulation is very low.

➤ For testing television receivers, a video signal, conveniently obtained from a standard receiver tuned to a local station, can be applied to the modulator. The picture modulation can then be put on any desired channel by tuning the signal generator.

**SPECIFICATIONS**

**Carrier Frequency Range:** 20 to 1000 megacycles. The insertion loss increases approximately 10 db at a carrier frequency of 10 megacycles due to output filter.

**Modulating Frequency Range:** 0 to 5 megacycles. Response is approximately 2 db down at 5 megacycles with a gradual roll-off to prevent serious phase distortion of video signals.

**Impedance:** The impedance looking into either the input or output terminals is a function of the bias and modulating voltages. This unit was designed for use with a 50-ohm source and a 50-ohm load. The impedance at the modulation terminals is approximately 600 ohms.

**Modulation:** With no greater than 50 millivolts r-f input, 30% amplitude modulation can be obtained at carrier frequencies between 20 and 1000 Mc. For optimum sine-wave modulation, an average crystal requires 1.5 volts at the bias terminal. The insertion loss under these conditions is approximately 12 db, and approximately 0.2 volt r-m-s at the modulation terminals will produce 30% modulation. Maximum percentage modulation is an inverse function of carrier frequency, and at 1000 megacycles is limited to about 30%. Peak modula-

tion voltage with respect to ground should not exceed 4 volts.

**Terminals:** The radio-frequency and modulating terminals are provided with TYPE 874 Coaxial Connectors. The modulation terminals will accept either a TYPE 874 Coaxial Connector or a TYPE 274-M Plug.

**Crystal Diode:** 1N21B.

**Accessories Supplied:** One TYPE 274-MB Plug.

**Other Accessories Required:** Terminal adaptors (page 62), unless generator and load are equipped with TYPE 874 Coaxial Connectors; 1.5-volt battery for fixed bias, or a 3-volt battery and a 10,000-ohm rheostat for adjustable bias.

**Accessories Available:**

- TYPE 874-G20 Fixed Attenuator, 20 db
- TYPE 874-G10 Fixed Attenuator, 10 db
- TYPE 874-R20 Patch Cord
- TYPE 1000-P5 V-H-F Transformer

(For description and prices, see pages 57, 60 and 98.)

**Dimensions:** (Width) 5 x (height) 4 x (depth)  $1\frac{1}{16}$  inches, over-all.

**Net Weight:** 1 pound.

Type	Code Word	Price
1000-P6   Crystal Diode Modulator . . . . .	APPLE	\$40.00

PATENT NOTICE. See Note 4, page viii.

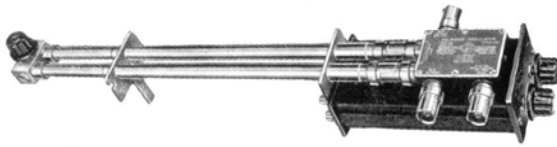

**TYPE 1000-P7 BALANCED MODULATOR**

**For 100% Linear AM and Pulse Modulation**

**USES:** This instrument is an insertion-loss modulator for pulse and sine-wave modulating the output of radio-frequency-generators over the carrier-frequency range of 60 to 2300 megacycles. Of its many uses the principal ones are for pulse modulation where a high degree of carrier suppression is desired with good rise-time characteristics, and for linear-modulation systems where full 100% modulation is required over a modulating frequency range of 0 to 20 megacycles. Typical uses are tests on: television and radar receivers, microwave relay systems using multiplex pulse-code modulation, omni-range and DME equipment, telemetering circuits, and narrow-band systems where incidental frequency modulation must be negligible.

The Balanced Modulator is particularly recommended for use with the TYPE 1217-A Unit Pulser or the TYPE 1391-A Pulse, Sweep,

and Time-Delay Generator for pulse-modulating the output of TYPES 1021-AU, 1021-AV and 1021-AW Standard-Signal generators.

**DESCRIPTION:** The instrument uses crystal diodes in two separate signal paths between the input and the output. In one path a coaxial phasing line, set to an odd multiple of one-half wave-length at the carrier frequency, is inserted. A simple high-pass filter is included in the output circuit.

For small r-f signals the impedances of the diodes can be controlled by varying the applied bias. The diode shunt capacity, which ordinarily limits the frequency range of a diode, is neutralized in the phasing line.

Bias and balance controls are provided for setting the operating points on the diode characteristics. The carrier can be balanced out, or any amount of carrier insertion can be provided by means of these adjustments.

**FEATURES:** ➤ High carrier suppression for pulse applications.

- Fast rise time.
- Linear 100% modulation.
- 0-20 Mc modulation frequency range.
- Useful up to 2300 Mc.
- Low incidental frequency modulation for testing narrow-band v-h-f and u-h-f systems.

**SPECIFICATIONS**

**Carrier-Frequency Range:** 60 to 2300 megacycles.

**Modulation-Frequency Range:** Flat from 0 to 20 megacycles. For pulsing, the rise-time contribution is less than 20 millimicroseconds.

**Impedance:** The impedance looking into either input or output terminals is a function of the bias and modulating voltages. The source and load impedances should be 50 ohms. The impedance at the modulation input is 50 ohms  $\pm 5\%$ . It is recommended that a TYPE 874-G20 (20 db) or a TYPE 874-G10 (10 db) fixed attenuator be used at the input and another at the output whenever the attenuation can be tolerated. The attenuator at the input is useful for isolation to minimize frequency modulation. The attenuator at the output provides a known source impedance for gain and noise measurements and insures that the proper load is presented.

**Modulation:** Double-sideband suppressed-carrier modulation, pulse modulation with 60-db carrier suppression between pulses, and 100% amplitude modulation can be obtained throughout the carrier frequency range. One volt, peak, at the modulation terminals is sufficient to produce full r-f output from a zero output initial condition.

**R-F Output:** A maximum output of 10 millivolts into a 50-ohm load can be obtained during pulses or at modulation peaks, with a source of 50 millivolts behind 50 ohms. At this level and at lower input levels the modulation characteristics are independent of input voltage. However, somewhat higher input volt-

ages and, consequently, higher output voltages are permissible if bias and balance readjustments are made for each change in level. The r-f source must not exceed 0.5 volt behind 50 ohms, or the crystal diodes may be damaged.

**Bias Supply:** Bias is supplied by a self-contained battery consisting of readily available, inexpensive flashlight cells.

**Terminals:** The radio-frequency input and output terminals and the modulation input terminals are TYPE 874 Coaxial Connectors. The radio-frequency input terminal is of proper elevation to plug directly into the output connector of the TYPE 1021-A Signal Generator.

**Crystal Diodes:** Two TYPE 1N21-B.

**Accessories Supplied:** One TYPE 1000-P7-28 40-cm Cable; one TYPE 1000-P7-28-2 80-cm Cable; one TYPE 874-C58 Cable Connector.

**Other Accessories Required:** Terminal adaptors, unless generator and load are equipped with TYPE 874 Coaxial Connectors; suitable coaxial cable for connecting modulation source.

**Accessories Available:** TYPE 874-G20 Fixed Attenuator, 20 db; TYPE 874-G10 Fixed Attenuator, 10 db; TYPE 1000-P5 VHF transformer; TYPE 874-R20 Patch Cord; TYPE 874 Adaptors to TYPES N, BNC, C, and other coaxial connectors and to TYPE 938 Binding Posts.

**Dimensions:** (Including fully extended adjustable line) 30 inches (width) x 3 inches (height) x 5 inches (depth) over-all. Length with line telescoped — 20 inches.

**Net Weight:** 6 pounds.

Type	Code Word	Price
1000-P7   <b>Balanced Modulator.....</b>	AWAKE	<b>\$200.00</b>

PATENT NOTICE. See Note 4, page viii.



# OSCILLATORS

A source of power or test voltage is a prerequisite to nearly all types of measurements — impedance, transmission, waveform, sensitivity, and many others. Since 1919 the General Radio Company has been supplying laboratory oscillators for this purpose and has always pioneered in new designs and circuits.

Functionally, these oscillators can be grouped under the following classifications:

(1) L-C and Resonant-Cavity Types — the frequency of oscillation is determined by inductive and capacitive elements or by resonant cavities.

(2) Beat-frequency types — the output frequency is the difference between the frequencies of two oscillators, one variable and one fixed. This type covers a wide frequency range with a single control.

(3) R-C degenerative types — the frequency is determined by resistive and capacitive elements, and the circuit is highly degenerated except at the pass frequency. This type of oscillator also covers a wide frequency range with a single control and, alternatively, can be designed to produce a number of fixed frequencies, as selected by a switch.

(4) Electro-mechanical types — the frequency is determined by a vibrating element.

The General Radio Company manufactures all of the functional types listed above, and the characteristics of available models are tabulated on the next page.

**L-C and Resonant-Cavity Types:** Although most useful at radio frequencies, the L-C oscillator, because of its stability, good waveform, and efficiency finds particular uses where fixed audio frequencies are needed.

General Radio makes two audio-frequency oscillators of this type. Of particular interest is the TYPE 1307-A Transistor Oscillator, a miniature instrument designed primarily for calibrating sound measuring equipment. The TYPE 1214-A Unit Oscillator, a conventional vacuum-tube oscillator, generates fixed frequencies of 400 and 1000 cycles and is useful for modulating high-frequency oscillators and as a source of moderately high power for bridge measurements.

At radio frequencies where tuning can be accomplished by air capacitors, the L-C circuit is the best and most economical frequency-determining system. The TYPE 1330-A Bridge Oscillator uses tuned circuits to cover a frequency range of 10,000: 1. The TYPES 1211-B, 1208-B, 1215-B and 1209-B Unit Oscillators cover a wide range of frequencies up through the u-h-f television bands. The

latter two use the butterfly circuit, which is a General Radio development.

At frequencies above 1000 Mc, resonant cavities are readily adapted to frequency control. The TYPE 1218-A Unit Oscillator covers a continuously tuned frequency range from 900 Mc to 2000 Mc with ganged quarter-wave lines, and the TYPE 1220-A Unit Klystron Oscillator can be adjusted to produce spot frequencies between 2700 Mc and 7500 Mc.

The radio-frequency oscillators can all be amplitude modulated with sine waves, and the TYPE 1218-A and TYPE 1220-A can be square-wave- and pulse-modulated as well. The TYPE 1220-A also has provision for frequency modulation up to deviations of  $\pm 7.5$  Mc, and the Unit Oscillators, in particular, are adapted for use with the mechanical sweeping device described on page 200.

**Beat-Frequency Types:** The first commercial beat-frequency oscillator was produced by General Radio in the middle 1920's. As the development of tubes and circuits has progressed, increasingly better models have been developed, culminating in the present TYPE 1304-B, whose logarithmic scale greatly facilitates frequency-response measurements. The TYPE 1303-A Two-Signal Audio Generator produces two output frequencies simultaneously, for measurements of intermodulation distortion in audio systems and for fixed-frequency detection with a variable supply frequency. Both of these oscillators can be used with the X-Y dial drives described on page 202 to operate graphic recorders.

**R-C Types:** The R-C degenerative type is a General Radio development, covered by a basic patent under which other manufacturers are licensed. Two models are offered, the TYPE 1301-A, whose primary characteristic is low distortion, and the TYPE 1302-A, designed for a wide frequency range. The former finds its greatest use as a tone source for distortion measurements.

The TYPE 1210-A Unit R-C Oscillator is a small, versatile instrument, which produces either sine-wave or square-wave output over a wide frequency range, and which becomes an inexpensive sweep oscillator when combined with the TYPE 908-P2 Synchronous Dial Drive, as described on page 202.

**Electro-Mechanical Types:** An audio-frequency tuning fork, the TYPE 723, is a useful source for continuous operation, as in modulating beacon transmitters and as a reference for frequency and time measurements.



Type	Name	Class	Frequency Range	Maximum Output	Open-Circuit Volts	Nominal Load Impedance	Harmonic Distortion	Power Supply	See Page No.
Audio and Low Frequency	1304-B	Beat-Frequency Audio Generator	20-20,000 c. 20,000-40,000 c.	1 Watt	50	600 ohms, balanced or grounded	<1%	A-C Line	104
	1301-A	Low-Distortion Oscillator	20-15,000 c. (27 fixed frequencies)	18 mw 100 mw	6.6 30	600 ohms, balanced or grounded 5000 ohms, grounded	<0.1%	A-C Line	103
	1302-A	Oscillator	10-100,000 c.	40 mw 20 mw 80 mw	10 5 20	600 ohms, balanced or grounded 300 ohms, grounded 5000 ohms, grounded	<1%	A-C Line	108
	1303-A	Two-Signal Audio Generator	Beat-Frequency	Normal-10 mw High-1 Watt	50	600 ohms, grounded	<0.2% <1%	A-C Line	106
	1307-A	Transistor Oscillator	Tuned Circuit	6 mw	2	600 ohms	<5%	Mercury Cells	109
	723	Vacuum-Tube Fork	Electro-Mechanical	50 mw	31	50,500,5000 ohms	<0.5%	A-C Line	109
	1214-A	Unit Oscillator	Tuned Circuit	200 mw	80	8000 ohms, grounded or ungrounded	<3%	A-C Line	112
	1210-B	Unit R-C Oscillator	R-C	80 mw 40 mw 90 mw	7 45 30	50 ohms, grounded 12,500 ohms, grounded 2,500 ohms, grounded	<1.5% <5% Square wave	Unit Power Supply	114
	1330-A	Bridge Oscillator	Tuned Circuit	0.75 w 1 w	12 10	50 ohms 20-80 ohms	<3%	A-C Line	110
	1211-B	Unit Oscillator	Tuned Circuit	2 w 200 mw		50 ohms		Unit Power Supply	113
	1208-B	Unit Oscillator	Sliding-Contact Tuned Circuit	100 mw		50 ohms		Unit Power Supply	116
	1209-B	Unit Oscillator	Butterfly Tuned Circuit	200 mw		50 ohms		Unit Power Supply	116
1215-B	Unit Oscillator	Semi-Butterfly	80 mw		50 ohms		Unit Power Supply	116	
1218-A	Unit Oscillator	Coaxial Line Tuned Circuit	200 mw		50 ohms		Unit Power Supply	116	
1220-A	Klystron Oscillator	Velocity-modulated	40 mw		50 ohms		Unit Power Supply	118	
SHF	1391-A	Pulse, Sweep and Time-Delay Generator	2700-3275 Mc 3400-4910 Mc 5100-5900 Mc 5925-7425 Mc					Type 1391-P1	120
	1217-A	Unit Pulser						Unit Power Supply	122
	1390-A	Random Noise Generator						A-C Line	124
	1219-A	Pulse Amplifier						A-C Line	123

See Page 119



**TYPE 1301-A  
LOW-DISTORTION  
OSCILLATOR**



This oscillator is characterized by its exceptionally pure waveform, which makes it an ideal source of test voltage for distortion measurements or a power source for audio bridge measurements.

Frequencies are selected instantly by push-button controls and include those recommended by the Federal Communications Commission for distortion measurements of broadcast transmitters. Thus, in combination with the TYPE 1932-A Distortion and Noise Meter, (page 226), it provides a fast and accurate means for making these transmitter tests. It is available optionally with panels in colors to match those used by leading transmitter manufacturers.

When this oscillator is used as a bridge power source, null balance is found more precisely and easily because of the low level of harmonic voltage present at the null point.

The oscillator uses the inverse-feedback RC circuit invented and developed by the General

Radio Company. Separate feedback networks control the frequency and amplitude independently, thus providing high stability and low distortion.

Mica capacitors and wire-wound resistors, chosen for maximum stability, are used in the frequency-determining network. Amplitude control is automatic, normally requiring no adjustment as various frequencies are selected.

- FEATURES:**
- Very low distortion, less than 0.1% over most of range.
  - Excellent frequency stability.
  - Constant output voltage.
  - Instant selection of any one of 27 test frequencies by push-button control.
  - Lower frequency range of 2 to 15 cycles available from convenient plug-in range-extension unit.
  - Any other frequency between 2 and 15,000 cycles may be obtained by plug-in resistors.

**SPECIFICATIONS**

**Frequency Range:** 27 fixed frequencies between 20 and 15,000 cycles. (Also 2 to 15 cycles by use of extension unit.)

**Frequency Control:** One push-button switch provides a frequency, and a second multiplies this frequency by 1, 10, or 100.

**Frequency Stability:** Changes in a-c line voltage or output load have no effect upon the frequency. Drift is not greater than 0.02% per hour after the first 10 minutes.

**Output Impedance:** A push-button switch selects one of three output impedances: 600 ohms balanced to ground, 600-ohms unbalanced, or 5000 ohms unbalanced.

The actual output impedance of the 5000-ohm circuit will vary between 1000 and 6000 ohms, depending on the setting of the volume control potentiometer, which also has slight effect on the 600-ohm output circuit. The 600-ohm balanced output circuit is balanced to all audio frequencies when operated into a balanced load of any impedance.

**Output Power:** 18 milliwatts into 600-ohm load, or 6.6 volts open circuit; 100 milliwatts into 5000-ohm load, or 30 volts open circuit. The output voltage, for either impedance position, will remain constant within ± 1 db throughout the frequency range.

**Waveform Distortion:** 5000-ohm output, not more than 0.1%; 600-ohm output, not more than 0.1% between

50 and 7500 cycles, and not more than 0.25% below 50 cycles.

When the range-extension unit is used, distortion will be less than 1% for the added range.

**Power Supply:** 105 to 125 (or 210 to 250) volts, 25 to 60 cycles. Total power consumption is about 45 watts. Specify line voltage and frequency when ordering.

**Tube Complement:** One each, 6X5-GT/G, 6B4-G, 6SL7-GT, 0D3/VR-150, 6Y6-G, 6SK7, 6SQ7-GT, 6SJ7, NE-17.

**Terminals:** Jack-top binding posts with standard 3/4-inch spacing, a ground terminal and a standard Western Electric double output jack are provided on the front panel. A standard multipoint connector provides duplicate output terminals on the rear of the instrument for relay-rack installation.

**Accessories Supplied:** ZCAP-5 Power Cord, multipoint connector, TYPE 1301-201 plug assembly, spare fuses.

**Mounting:** Relay-rack panel. End frames are available to adapt the instrument for table mounting. (See price table below.)

**Panel Finishes:** Standard General Radio black crackle. Certain other standard finishes to match transmitters can be supplied at small extra cost.

**Dimensions:** Panel (length) 19 x (height) 7 inches; depth behind panel, 12 inches. **Net Weight:** 31½ pounds.

Type	Code Word	Price
1301-A	OZONE	\$505.00
1301-P1	OVATE	80.00
FRI-412	ENDFRAMDIG	13.00 Pair
<b>Low Distortion Oscillator</b>		
<b>Range Extension Unit (2 to 1500 cps)</b>		
<b>Aluminum End Frames</b>		

PATENT NOTICE. See Notes 2 and 9, page viii.



## TYPE 1304-B BEAT-FREQUENCY AUDIO GENERATOR

**USES:** For amplitude-frequency tests on audio frequency equipment — lines, amplifiers, filters, equalizers, transducers, and other networks — this beat-frequency generator is the best test-signal source that can be used. Its especial fitness for these applications lies in four of its characteristics:

- (1) its frequency scale is logarithmic;
- (2) it covers the entire audio range in one sweep of the dial;
- (3) its output voltage is constant with frequency.
- (4) its distortion is extremely low.

These same advantages make possible the use of a motor drive for the dial and a graphic recorder to plot frequency characteristics automatically. TYPE 908 Dial Drives that attach to the dial in place of the knob enable the generator to be used with recorders. The TYPE 908-P1, for instance, covers a frequency interval of an octave on the TYPE 1304-B in 15 seconds. This rate is widely accepted as a standard for graphic recording.

The TYPE 908 Dial Drives are fully described on page 202.

As a general-purpose audio generator, the TYPE 1304-B finds constant use in the electronics laboratory, as a power source for bridge measurements, as a modulator for r-f signal generators, and as a test source for acoustic work at both audio and ultrasonic frequencies.

**DESCRIPTION:** This generator has a number of unusual design features that contribute to superior performance and ease of operation. Two radio-frequency oscillators, one fixed and one variable, feed a pentagrid converter

through buffer amplifiers. The resulting difference frequency, after passing through a low-pass filter, is amplified in a degenerative amplifier. The output stage of this amplifier is the unique, low-distortion, single-ended, push-pull circuit.\*

The oscillator output level is continuously adjustable, and the output can be connected for either balanced or unbalanced use. The unbalanced output circuit contains a three-step attenuator. The output voltmeter is calibrated in dbm and open-circuit output volts.

The output voltmeter is used to standardize the frequency calibration of the oscillator when the output frequency is set to either the power-line frequency or to zero beat.

The frequency dial carries a logarithmic frequency scale for the range 20 c to 20 kc, and it is driven by a slow-motion gear-reduction drive, essentially free from backlash. A cycles-increment dial provides a means of varying the frequency over a range of  $\pm 50$  cycles at any setting of the main dial.

A second range from 20 kc to 40 kc is available by the operation of a single panel switch.

For permanent or relay-rack installation, output terminals are provided at the rear of the instrument, through standard multipoint connectors. The panel output terminals are TYPE 938 binding posts on  $\frac{3}{4}$ -inch spacing.

**FEATURES:** ➤ Essentially constant output voltage.

➤ Output voltmeter for accurate and rapid setting, and accurate attenuator.

\* A. P. G. Peterson and D. B. Sinclair, "A Single-Ended Push-Pull Audio Amplifier," Proc. I.R.E., vol. 40, pp. 7-11, January, 1952.



- Frequency coverage from 20 c to 40 kc.
- Audio spectrum — 20 c to 20 kc covered in a single sweep of the dial.
- High stability of both output and frequency.

- Very low hum level.
- Excellent waveform.
- Dial can be motor driven.
- High quality components, stabilized power supply, and advanced circuit design.

**SPECIFICATIONS**

**Frequency Range:** 20 to 40,000 cycles in two ranges.  
**Frequency Controls:** The main control is engraved from 20 to 20,000 cycles per second and has a true logarithmic frequency scale. The total scale length is approximately 12 inches. The effective angle of rotation is 210°, or 80° per decade of frequency. For the higher range, throwing a panel switch adds 20 kc to the scale frequency. The frequency increment dial is calibrated from +50 to -50 cycles.  
**Frequency Calibration:** The calibration of the frequency control dial can be relied upon within  $\pm(1\% + 0.5 \text{ cycle})$  after the oscillator has been correctly set to the line frequency or to zero beat. The 20 kc added by the range switch is accurate within  $\pm 0.5\%$ . The accuracy of calibration of the frequency-increment dial is  $\pm 1 \text{ cycle}$ .  
**Zero-Beat Indicator:** The output voltmeter is used to indicate zero beat.  
**Frequency Stability:** The drift from a cold start is less than 7 cycles in the first hour and is essentially completed within two hours.  
**Output Voltmeter:** Calibrated in volts output at open circuit, and in dbm. Above 10% of full scale the calibration is accurate within  $\pm 5\%$  of the reading.  
**Output Attenuator:** The output attenuator is for use only with single-ended output. It has three steps of 20 db each, with an accuracy of  $\pm 1\%$  of the nominal attenuation.  
**Output Control:** For each step of the attenuator the output voltage can be varied continuously from zero to the maximum voltage.  
**Output Voltage:** Continuously variable from below 5 millivolts to 50 volts, open circuit. Full-scale, open-circuit output voltages of 50 millivolts, 500 millivolts, 5 volts, and 50 volts are provided. For a 600-ohm resistive load the variation of output voltage with frequency is as follows:  
**Normal Range:** Between 20 and 20,000 cycles the output voltage varies less than  $\pm 0.25 \text{ db}$ .  
**Add 20 KC Range:** Between 20 and 30 kc the output voltage varies less than  $\pm 0.5 \text{ db}$ . Between 30 and 40 kc the variation is less than  $\pm 1 \text{ db}$ . For open-circuit operation the output voltage rises considerably at the higher frequencies.  
**Output Impedance:** 600 ohms, resistive, within  $\pm 2\%$ . At  $\pm 20 \text{ dbm}$  setting of the output attenuator, the output may be used either balanced or with one side grounded. With one side of the output grounded, the attenuator may be used throughout its entire range.

**Output Power:** 1 watt maximum into a 600-ohm resistive load.  
**Harmonic Distortion:** The total harmonic content is less than 0.25% from 100 to 10,000 cycles. Below 100 cycles the harmonic content increases and may reach 0.5% at 50 cycles. Above 10,000 cycles the harmonic content is less than 1%.  
**A-C Hum:** Less than 0.1% of the output voltage for output voltmeter readings above 10% of full scale.  
**Terminals:** TYPE 938 Binding Posts and standard Western Electric double output jack on panel; a standard four-terminal socket at the rear.  
**Mounting:** Aluminum, 19-inch, relay-rack panel; aluminum cabinet. For table mounting (TYPE 1304-BM), aluminum end frames are supplied to fit ends of cabinet; for relay-rack mounting (TYPE 1304-BR), brackets for holding cabinet in rack are supplied. Relay-rack mounting is so arranged that panel and chassis can be removed from cabinet, leaving cabinet in rack, or cabinet can be removed from rear of rack, leaving panel attached to rack.  
**Power Supply:** 105 to 125 (or 210 to 250) volts, 50 to 60 cycles. Power consumption is about 100 watts.  
**Tube Complement:**  
 2 — 6SL7-GT                    1 — 6SA7  
 2 — 6AU5-GT                  1 — 12AT7  
 2 — 0D3                         1 — 5V4-G  
**Accessories Supplied:** TYPE CAP-35 Power Cord, four-terminal plug, and spare fuses.  
**Dimensions:** 19 $\frac{3}{8}$  x 15 $\frac{1}{4}$  x 7 $\frac{1}{4}$  inches, over-all.  
**Net Weight:** 39 pounds.



TYPE 908-P Dial Drive mounted to drive the frequency control of TYPE 1304-B Generator.

Type		Code Word	Price
1304-BM	Beat-Frequency Audio Generator, Bench Model.....	CAROL	\$575.00
1304-BR	Beat-Frequency Audio Generator, Relay Rack Model.	CARGO	575.00

PATENT NOTICE. See Notes 1, 2, and 15, page viii.

**OTHER BEAT-FREQUENCY OSCILLATORS**

The TYPE 1107-A (page 82) has a linear scale from 0 to 5000 cycles and is used as an interpolating device in frequency measurements. The TYPE 1303-A (page 106) is designed particularly for intermodulation distortion tests.



FOR  
INTERMODULATION  
DISTORTION TESTS  
AND  
GENERAL  
LABORATORY USE

### TYPE 1303-A TWO-SIGNAL AUDIO GENERATOR

**USES:** The TYPE 1303-A Two-Signal Audio Generator is primarily a test-signal source for intermodulation distortion measurements. It is suitable for use in measurements by all three of the usual non-linear distortion measurement methods. These are:

- (1) The harmonic method.
- (2) The intermodulation method using a strong low-frequency tone and a weaker high-frequency tone (standardized by the SMPTE).
- (3) The intermodulation method, sometimes called a double-tone test, using two tones of equal intensity (recommended by the CCIF).

The TYPE 736-A Wave Analyzer is recommended as a detector for these distortion tests.

The Two-Signal Audio Generator is also an excellent general-purpose audio-frequency source for tests on audio-frequency lines, networks, and amplifiers; for modulating signal generators and test oscillators; and for acoustic tests, recording tests, and bridge measurements.

**DESCRIPTION:** The TYPE 1303-A Two-Signal Audio Generator utilizes a beat-frequency system to provide the various signals available at the output. Three radio-frequency oscillators are included, one fixed and the other two adjustable. When a signal output of a single-frequency tone is desired, the fixed and one

of the adjustable oscillators feed a pentagrid converter. The resulting difference frequency, after passing through a low-pass filter, is amplified in a degenerative amplifier. When a signal output of two tones is desired, the third oscillator and one of the other two oscillators feed an additional pentagrid converter. The resulting difference frequency, after filtering, is added to the output of the first pentagrid converter. This combined signal is amplified in a degenerative amplifier.

The output level is adjustable by an output-level control and a T-pad attenuator. This level is indicated by a voltmeter calibrated in voltage and in decibels with respect to an output of one milliwatt into a 600-ohm load. Following the voltmeter is a six-position, 600-ohm attenuator also calibrated in decibels.

For bench use the signal generator is supplied with end supports, which can be removed to permit permanent installation of the instrument in a standard 19-inch relay rack.

**FEATURES:** ➤ Can be used as a single-frequency beat-frequency oscillator from 20 to 40,000 cycles.

➤ Supplies combinations of two frequencies for intermodulation distortion tests.

➤ The ratio of the voltages of the two frequencies is adjustable.

➤ The constant-difference-frequency feature of the two-signal output is particularly con-



venient for the CCIF method of testing.

- Harmonics and intermodulation products in the oscillator output are very low.
- Output voltage is essentially constant over entire frequency range.

- Frequency and voltage stability are high.
- Output meter and attenuator are provided, so that the oscillator can be used as a standard-signal generator for such measurements as voltage, gain, and attenuation.

### SPECIFICATIONS

**Frequency Range:** The four settings of the OUTPUT FREQUENCIES control, labelled A, B, C, and D, respectively, correspond to the following output combinations:

A: 20 to 20,000 cycles.

B: 20,000 to 40,000 cycles.

C: One frequency,  $f_1$ , of 20 to 20,000 cycles and a second frequency,  $f_2$ , higher than  $f_1$  by a fixed amount, which may be between 0 and 10,000 cycles. As  $f_1$  is varied the difference frequency remains constant.

D: One frequency,  $f_1$ , of 20 to 20,000 cycles and a second frequency,  $f_2$ , of 20 to 10,000 cycles.

**Frequency Control:** The main control is calibrated from 20 to 20,000 cycles per second and has a true logarithmic frequency scale. The total scale length is approximately 12 inches. The effective angle of rotation is  $240^\circ$ , or  $80^\circ$  per decade of frequency. The frequency-increment dial is calibrated from +50 to -50 cycles. 20 kc is switched in to give 20 kc to 40 kc. A  $3\frac{1}{4}$ -inch auxiliary frequency dial,  $f_k$ , is engraved from 0 to 10,000 cycles over approximately  $180^\circ$  of dial rotation. The scale distribution is approximately logarithmic above 500 cycles and approximately linear below 500 cycles.

**Frequency Calibration: Main dial, 20 to 20,000 cycles:** The calibration can be standardized at any time to a zero beat setting. The calibration of the frequency control dial can be relied upon within  $\pm(1\% + 0.5 \text{ cycle})$  after the oscillator has been correctly set to zero beat.

The accuracy of calibration of the frequency-increment dial is  $\pm 1$  cycle.

**Auxiliary Dial, 20 to 10,000 cycles:** The frequency can be standardized within 1 cycle by setting to zero beat. The calibration of the dial can be relied upon within  $\pm(3\% + 10 \text{ cycles})$ .

**Zero Beat Indicator:** The output voltmeter can be used to indicate zero beat.

**Frequency Stability:** The drift from a cold start is less than 7 cycles in the first hour and is essentially completed within two hours.

**Output Attenuator:** The output attenuator has six steps from -100 to 0 db with an accuracy of  $\pm 1\%$  of the nominal attenuation.

**Output Control:** For each step of the attenuator the output voltage can be continuously varied from zero to maximum voltage. With two-frequency output, the ratio of the voltages at the two frequencies can be adjusted from less than 0.1 to greater than 10 by means of a control calibrated from 0.1 to 10.

**Output Voltage:** NORMAL output provides full-scale, open-circuit output voltages of 50 microvolts, 500 microvolts, 5 millivolts, 50 millivolts, 500 millivolts, and 5 volts. HIGH output provides full-scale, open-circuit output voltages from 500 microvolts to 50 volts. When the output voltage is of two frequencies, the indicated voltage is the sum of the voltages at the two frequencies.

For a matched resistive load, the variation of output voltage with frequency is as follows:

$f_1$ , range A, and  $f_1$ , ranges C and D: Between 20 and 20,000 cycles the output voltage varies less than  $\pm 0.25$  db.

$f_1 + 20$  kc, range B: Between 20 and 35 kilocycles the

output voltage varies less than  $\pm 0.3$  db. It may drop 1 db at 40 kilocycles.

$f_2$ , range C: Between 20 and 20,000 cycles the output voltage varies less than  $\pm 0.3$  db. It may rise 0.75 db at 30 kilocycles.

$f_2$ , range D: Between 20 and 10,000 cycles the output voltage varies less than  $\pm 0.25$  db.

**Output Voltmeter:** Calibrated in volts output at open circuit and in dbm. Above 10% of full scale, the calibration is accurate within  $\pm 5\%$  of the reading.

**Output Impedance:** 600 ohms, resistive, within  $\pm 2\%$ . One side of the output circuit is grounded.

**Output Power:** HIGH output is 1 watt maximum into a matched load. NORMAL output is 100 milliwatts, maximum, into a matched load.

**Harmonic and Intermodulation Distortion:** Distortion is not affected by the load impedance or the settings of the output control and attenuator except on HIGH output with the 0-db attenuator position. On HIGH output with the 0-db attenuator position and with a load less than 600 ohms, the distortion will be higher than the values quoted below, which apply to all other conditions of load and output settings.

**Harmonic Distortion:** For NORMAL output the total harmonic content is less than 0.25% from 100 to 8000 cycles. Below 100 cycles the harmonic content increases and may reach 0.5% at 50 cycles. For HIGH output the total harmonic content is less than 1% from 100 to 8000 cycles. Below 100 cycles the harmonic content increases and may reach 2% at 50 cycles.

**Intermodulation Distortion:** (1) CCIF: Quadratic and cubic distortion for frequencies above 1000 cycles and a difference frequency greater than 100 cycles are each less than 0.15% on NORMAL output and less than 0.5% on HIGH output.

(2) SMPTE: The square root of the sum of the squares of the quadratic and cubic distortion for  $f_1$  between 40 and 300 cycles and  $f_2$  between 1000 and 15,000 cycles is less than 0.5% on NORMAL output and less than 3% on HIGH output.

**A-C Hum:** Less than 0.1% of the output voltage.

**Terminals:** TYPE 938 Binding Posts on panel. 4-terminal socket in back.

**Mounting:** 19-inch relay rack panel with walnut end pieces.

**Power Supply:** 105 to 125 (or 210 to 250) volts, 50 to 60 cycles. Power consumption 135 watts.

**Tube Complement:**

4-6SL7-GT	1-5R4-GY
3-6SA7	1-6Y6-G
2-6V6-GT	1-6SJ7
2-6SN7-GT	1-0D3
1-6J5-GT	1-3-4 Amperite
1-6H6	

**Accessories Supplied:** TYPE CAP-35 Power Cord, multi-point plug, and spare fuses.

**Other Accessories Required:** For measurements of harmonic and intermodulation distortion, the TYPE 736-A Wave Analyzer is recommended as a detector (page 224).

**Dimensions:** (Width)  $19\frac{1}{4}$  x (height)  $17\frac{7}{8}$  x (depth)  $17\frac{7}{8}$  inches, over-all.

**Net Weight:** 81 pounds.

Type	Code Word	Price
1303-A Two-Signal Audio Generator.....	BEGET	\$1550.00

PATENT NOTICE. See Notes 1 and 2, page viii.

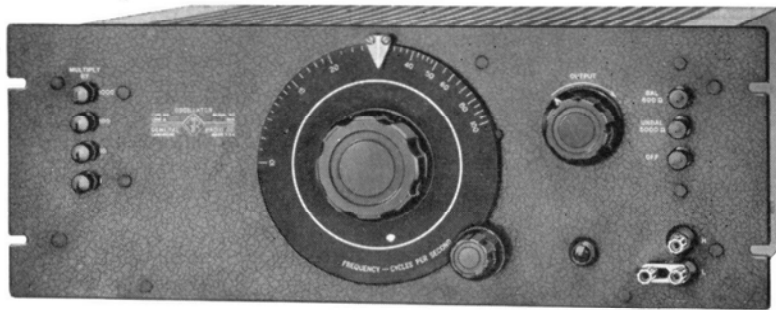

**TYPE 1302-A  
OSCILLATOR**

**USES:** The wide range and excellent frequency and amplitude stability of this oscillator make it a superior source of power for bridges and other measurement networks. It is particularly recommended for use with the TYPE 716-C Capacitance Bridge and is used in the TYPE 1610-A Capacitance Measuring Assembly (page 24). The entire audio spectrum is covered, and the upper frequency limit overlaps the low end of r-f generators. The oscillator can be used on either balanced or grounded systems.

**DESCRIPTION:** This instrument is an R-C oscillator employing an inverse-feedback circuit. The frequency-determining network is a Wien bridge, in which the capacitive elements are controlled by the main frequency dial, and two resistive elements are selected by a range switch.

The amplitude of oscillation is held constant by using a second bridge section, one

arm of which is a non-linear resistance. A buffer amplifier is inserted ahead of the output level control to minimize reaction on the oscillator frequency.

The output is balanced to ground for 600-ohm loads and grounded for 300- or 5000-ohm loads. Considerable deviations in load from these nominal values can be tolerated without appreciably increasing the distortion.

**FEATURES:** ➤ Wide frequency range, 10 to 100,000 cycles.

- Excellent frequency stability.
- Low harmonic distortion.
- Semi-logarithmic scale eliminates crowding at the low-frequency end and still allows precision setting of high frequencies.
- Voltage regulation in the power supply removes effects of line-voltage transients and allows the instrument to operate over a wide range of supply voltages.

**SPECIFICATIONS**

**Frequency Range:** 10 to 100,000 cycles in four ranges.  
**Frequency Control:** The main control dial is engraved from 10 to 100 cycles over a scale length of approximately 8 3/4 inches. Four multiplier switches multiply the scale frequencies by 1, 10, 100, or 1000.  
**Frequency Calibration:** ± (1 1/2% + 0.2 cycle).  
**Frequency Stability:** Warm-up drift is less than 1% in the first ten minutes, less than 0.2% during the next hour.  
**Output Impedance:** Balanced 600 ohms and grounded 5000 ohms. The internal impedance of the 600-ohm output is constant at 550 ohms unless the LOW output terminal is grounded. The output impedance is then 300 ohms, grounded. In the 5000-ohm output impedance position, (for 5000-ohm loads) the internal impedance of the oscillator averages approximately 400 ohms.  
**Output Voltage:** At least 20 volts open circuit on 5000-ohm output, and 10 volts open circuit on 600-ohm output. The output voltage is constant within ±1.0 db over the entire frequency range.  
**Output Power:** 80 milliwatts, maximum, into a 5000-ohm load; 40 milliwatts, maximum into a balanced 600-ohm load; 20 milliwatts into a 300-ohm load.  
**Waveform:** Total harmonic content is less than 1% for

all output values and at all frequencies, for 5000-ohm output; less than 0.5% for 600-ohm output.

**A-C Hum:** 5000-ohm output, 24 millivolts, maximum. 600-ohm output, 12 millivolts, maximum.

**Terminals:** Jack-top binding posts with standard 3/4-inch spacing. The separate ground terminal has a strap which can be used to ground the LOW output terminal. Output is also available at a multipoint connector at the rear of the instrument. A mating connector is supplied.

**Mounting:** Relay-rack panel easily adapted for table mounting by the addition of two frames at the ends of the panel (see price list below).

**Power Supply:** 105 to 125 (or 210 to 250) volts, 50 to 60 cycles.

Total power consumption is 90 watts.

**Tube Complement:** Two each: 6SL7-GT, 6B4-G. One each: 6AK6, 6F6, 6V6-GT, 6J5-GT, 5V4-G, 0D3.

**Accessories Supplied:** TYPE ZCAP-5 Power Cord, TYPE 274-ND Shielded Plug, spare fuses, and multipoint connector.

**Dimensions:** Panel, (width) 19 x (height) 7 inches; depth behind panel, 12 inches.

**Net Weight:** 30 pounds.

Type		Code Word	Price
<b>1302-A</b>	<b>Oscillator</b> .....	FINAL	<b>\$450.00</b>
<b>FRI-412</b>	<b>Aluminum End Frames</b> .....	ENDFRAMDIG	<b>13.00 Pair</b>

PATENT NOTICE. See Notes 1, 2, 9, page viii.





### TYPE 1307-A TRANSISTOR OSCILLATOR

In addition to its primary use as a power source for the TYPE 1552-B Sound-Level Calibrator, this pocket-size oscillator is most convenient for use in continuity checks of audio systems, in setting operating levels, in checking sensitivity of oscillographs, in making preliminary calibrations of electronic systems, and as a power source for bridge measurements at 400 and 1000 cycles.



**DESCRIPTION:** The oscillator uses a P-N-P junction transistor in a Hartley circuit. The inductor in the tuned circuit includes a winding for coupling to the load, and a rectifier-type voltmeter is connected across this winding to indicate output voltage.

#### SPECIFICATIONS

**Frequency:** 400 and 1000 cycles.  
**Frequency Accuracy:**  $\pm 3\%$  at 2 volts output into 600-ohm resistive load.  
**Output:** Adjustable to a maximum of at least 2 volts into a 600-ohm load.  
**Distortion:** Less than 5% at 400 c with 2 volts across a resistive 600-ohm load.  
**Voltmeter:** Calibrated in volts, with 3 volts full scale.  
**Output Circuit:** Output cable terminated in a TYPE 274-MB Double Plug with no connection to the case.

**Batteries:** Three mercury A batteries (Mallory RM-1 or equivalent) are supplied.  
**Transistor:** One P-N-P junction transistor (Raytheon TYPE 2N131 or equivalent).  
**Case:** Aluminum, black finish.  
**Carrying Case:** Leather case with a strap is available. (TYPE 1555-P1)  
**Dimensions:** 6 x 3 1/8 x 2 1/2 inches, over-all, excluding output cable.  
**Net Weight:** 1 pound, 14 ounces, with batteries.

Type		Code Word	Price
1307-A	Transistor Oscillator.....	OMEGA	\$80.00
1555-P1	Leather Carrying Case.....	CASER	10.00

### TYPE 723 VACUUM-TUBE FORKS

The TYPE 723 Vacuum-Tube Forks are compact, highly stable, fixed-frequency electromechanical oscillators with excellent waveform. They are used for distortion measurements, modulators, power sources for impedance bridges and transmission-line measurements, and as sources of timing pulses for oscillograms. An a-c power supply is included that may be replaced with batteries, if desired.

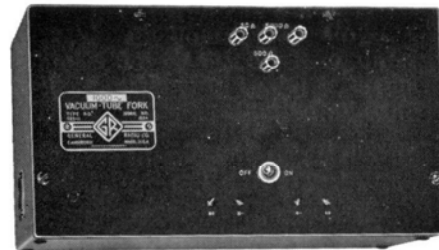

#### SPECIFICATIONS

**Frequency:** 400 or 1000 cycles.  
**Frequency Stability:** Total warm-up frequency drift 0.15 to 0.2%, most of which occurs in first half-hour of operation. Temperature coefficient of frequency  $-0.008\%$  per degree Fahrenheit. Voltage coefficient of frequency is negligible. Frequency is independent of load.  
**Accuracy:**  $\pm 0.05\%$  at ambient temperature 25° Centigrade.  
**Output:** 45 milliwatts into a matched load.  
**Output Impedance:** 50, 500, or 5000 ohms.  
**Waveform and Hum Level:** Total harmonic content is less than 0.5%. Power-supply hum is less than 0.1%.

**Power Supply:** 105 to 125-volt, 40 to 60-cycle line. Batteries can be substituted for the power pack for field use. For battery operation, one Burgess 4FH (1 1/2-volt) and two Burgess 30NX (45-volt), or equivalent, are required. The ON-OFF switch is arranged to control either a-c line or battery current.  
**Tube Complement:** 1-1A5, 1-0C3.  
**Accessories Supplied:** TYPE CAP-35 Power Cord.  
**Mounting:** Phenolic panel; walnut-finish hardwood cabinet.  
**Over-all Dimensions:** (Length) 10 5/8 x (width) 6 1/4 x (height) 7 3/4 inches.  
**Net Weight:** 9 1/4 pounds.

Type		Code Word	Price
723-C	Vacuum Tube Fork (1000 cycles).....	SOLID	\$185.00
723-D	Vacuum Tube Fork (400 cycles).....	SULKY	200.00

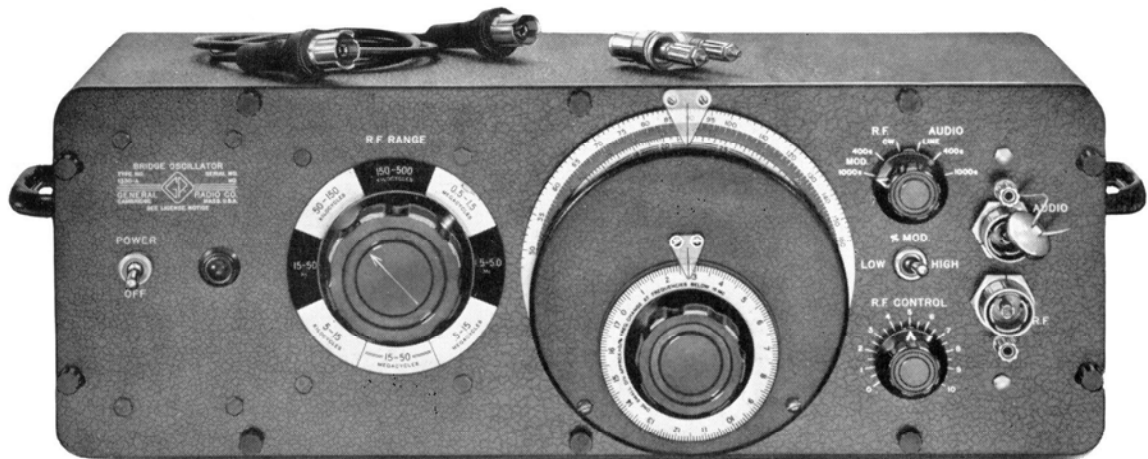

### TYPE 1330-A BRIDGE OSCILLATOR

**USES:** The Bridge Oscillator is a stable, variable-frequency source of power for bridge and other measurements at audio and radio frequencies. It supplies three fixed audio frequencies and a wide range of radio frequencies, continuously adjustable, with power output sufficiently high for most laboratory measurements. It covers the frequency range of the TYPE 1606-A and TYPE 916-AL Radio-Frequency Bridges and the TYPE 821-A Twin-T. At audio frequencies it can be used with the TYPE 716-C Capacitance Bridge, the TYPE 667-A Inductance Bridge, and the TYPE 561-D Vacuum-Tube Bridge. Its power output of about one watt is adequate for most resonant-circuit measurements. The TYPE 1330-A Bridge Oscillator is an economical, general-purpose, laboratory source, of maximum utility and adaptability.

**DESCRIPTION:** Both the circuit and the mechanical construction of the Bridge Oscillator are similar to those used in the TYPE 1001-A Standard-Signal Generator (page 94), but a higher-power oscillator tube is used, and the

aperiodic output stage has been omitted. Tuning capacitor and inductors are ruggedly constructed to assure frequency stability, the oscillator circuits are doubly shielded to minimize stray fields, and a modulating circuit of unusual design provides excellent modulation characteristics over the radio-frequency range.

Modulation is available at two audio frequencies and at two levels, selected by switches.

Output terminals are TYPE 874 Coaxial Connectors, and coaxial cables and adaptors are supplied to permit complete shielding from the oscillator to the measuring circuit.

- FEATURES:**
- Wide frequency range
  - Internal modulation available
  - Good frequency stability with low distortion
  - Excellent shielding
  - One watt output over much of the radio frequency range
  - Rugged and compact construction



The TYPE 1330-A Bridge Oscillator used as a source for the TYPE 821-A Twin-T Impedance-measuring circuit.



View of the oscillator unit removed from the cabinet. The servicing cable is shown coiled in its storage position. This cable makes possible the operation of the r-f section when it is removed from the cabinet for complete servicing.

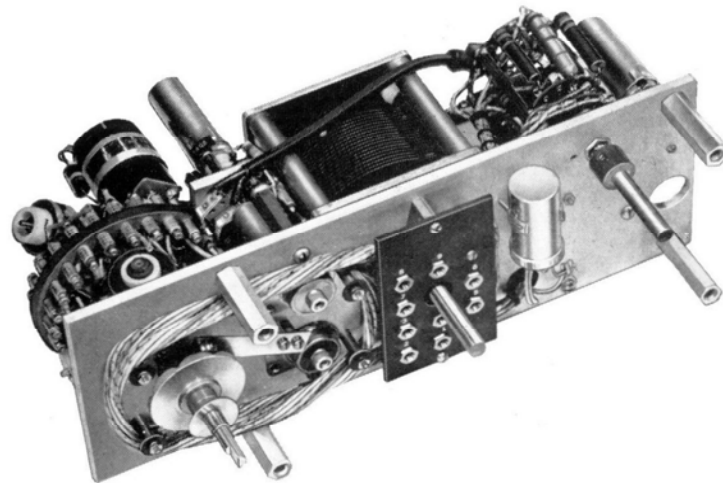

SPECIFICATIONS

**Frequency Range:** Three fixed audio frequencies (power-line frequency, 400 c, and 1000 c) and a continuous frequency spectrum from 5 kc to 50 Mc in eight direct-reading ranges as follows: 5 to 15 kc, 15 to 50 kc, 50 to 150 kc, 150 to 500 kc, 0.5 to 1.5 Mc, 1.5 to 5 Mc, 5 to 15 Mc, and 15 to 50 Mc.

**Frequency Accuracy:**  $\pm 5\%$  for the 400- and 1000-cycle fixed frequencies,  $\pm 2\%$  for the carrier frequencies above 150 kilocycles, and  $\pm 3\%$  for the carrier frequencies below 150 kilocycles under no-load conditions. A 50-ohm resistive load may cause a frequency shift of as much as  $\pm 5\%$  at some of the lower carrier frequencies; above 150 kilocycles, the frequency shift due to a 50-ohm load is usually less than  $+1\%$ . From 5 kilocycles to 15 Mc, the dial calibration is logarithmic.

**Incremental-Frequency Dial:** The slow-motion dial indicates frequency increments of 0.1% per division from 5 kc to 15 Mc.

**Output Voltage and Power:** The AUDIO output jack provides a fixed voltage output of approximately 12 volts open circuit, or a power output of approximately  $\frac{3}{4}$  watt into a matching 50-ohm load; the output at the R-F jack is controlled by the R-F control and supplies adjustable output for the 5 kc to 50 Mc range; over the mid-frequency range, the open circuit output voltage is approximately ten volts, and the output power into a 50-ohm load (output control at maximum) is approximately one watt. The output falls off at the upper and lower ends of the frequency spectrum.

**Output Impedance:** 50 ohms at the AUDIO jack; between 20 and 80 ohms, depending on frequency, at the R-F jack when the 250-ohm output control is at maximum.

**Modulation:** The R-F range (15 kc to 50 Mc) can be internally amplitude-modulated at either 400 c or 1000 c at the two nominal modulation levels of 25% and 50%. There is no provision for external modulation.

**Envelope Distortion:** Less than 6% at the 50% modulation level; less than 3% at 25% modulation.

**R-F Distortion:** With the output terminated in a 50-ohm resistive load, and the R-F control at its maximum setting, r-f distortion is 3.5% over most of the range; at the lower radio frequencies it is 7%.

**A-F Distortion:** 5% at 400 and 1000 cycles.

**Leakage:** Stray fields at 1 Mc are less than  $50\mu\text{v}$  per meter at two feet from the oscillator.

**Controls:** A switch for selecting between AUDIO (LINE, 400 c or 1000 c) and R-F output (CW or MODulated — 400 c, or 1000 c); a switch for selecting between HIGH and LOW modulation; a voltage divider for controlling the R-F output; a range switch; a calibrated dial and a vernier dial for setting the radio frequency; a power switch.

**Accessories Supplied:** TYPE 874-R22 Coaxial Cable, TYPE 874-Q2 Adaptor, TYPE 874-C58 Cable Connector, TYPE 874-PB58 Panel Connector, TYPE TO-44 Adjustment Tool (mounted on r-f shield cover), TYPE CAP-35 Power Cord, and spare fuses.

**Mounting:** Aluminum panel finished in black-crackle lacquer. Aluminum cabinet is finished in black wrinkle and is provided with carrying handles. Cabinet can be removed for relay-rack mounting.

**Power Supply:** 115 (or 230) volts at 40 to 60 cycles. The power input is about 30 watts.

**Tube Complement:** Two 6AQ5's and one 6X4.

**Terminals:** TYPE 874 Coaxial Terminals are provided for both the AUDIO output and the R-F output.

**Dimensions:** (Height)  $7\frac{1}{2}$  x (width)  $21\frac{3}{4}$  x (depth) 11  $\frac{1}{4}$  inches, over-all.

**Net Weight:** 37  $\frac{1}{2}$  pounds.

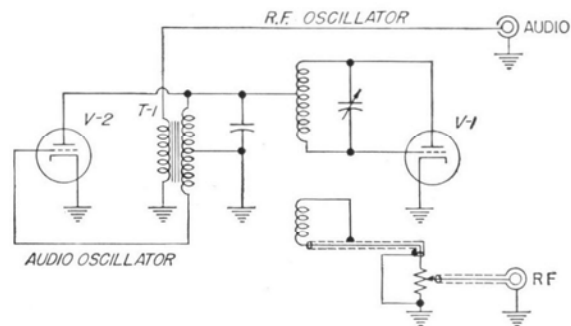

Type	Code Word	Price
1330-A   Bridge Oscillator .....	ACORN	\$540.00

PATENT NOTICE. See Note 4, page viii.



UNIT OSCILLATORS

GENERAL RADIO'S LOW-COST, HIGH-QUALITY LINE

These oscillators are efficient, well-shielded sources of power, built for maximum utility in the research laboratory, the production test department, or the college experimental class. They have wide frequency ranges with accurate calibration, provision for modulation, and higher-than-average, continuously variable output power. They are laboratory-quality instruments with great adaptability and are offered at economy prices that help the laboratory budget.

Unit oscillators have moderate power requirements met easily by inexpensive Unit Power Supplies. The TYPE 1203-A Unit Power Supply is an efficient supply at low cost. The TYPE 1202-A Unit Vibrator Power Supply is intended primarily for use in the field where batteries are the only source of power, although it also can be operated from a-c power lines. The TYPE 1201-A Unit Regulated Power Supply is available for best performance through automatic regulation of oscillator plate voltage.

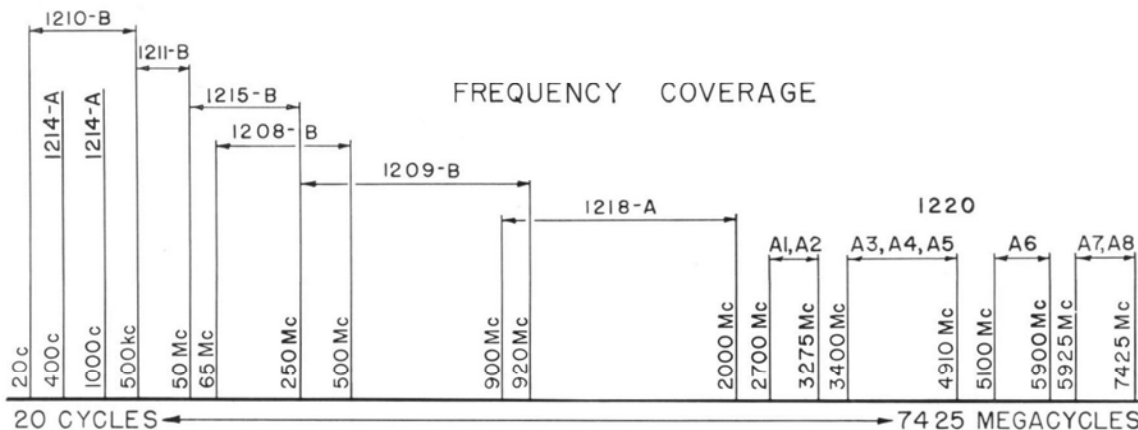

TYPE 1214-A UNIT OSCILLATOR

The TYPE 1214-A Unit Oscillator is a compact and inexpensive audio oscillator with two fixed frequencies, 400 and 1000 cycles. It is a convenient modulator for the high-frequency unit oscillators and is useful as a power source for bridge measurements. The distortion is low, and the output level is higher than that of most small oscillators. The unit can be used with the output ungrounded. The a-c power supply is built into the instrument.



SPECIFICATIONS

- Frequency:** 400 and 1000 cycles accurate to  $\pm 2\%$ .
- Output:** The power output is over 200 milliwatts into a load of 8000 ohms with the output control (10 k $\Omega$ ) at maximum. Open-circuit output voltage is about 60 volts.
- Distortion:** Less than 3% into an 8000-ohm load.
- Output Circuit:** The output can be isolated from ground for using the oscillator as a modulator in the plate circuit of a high-frequency oscillator, such as the General Radio Unit Oscillators.
- Controls:** A toggle switch to select frequency, an output control, and a power switch.
- Terminals:** The output terminals are jack-top binding

- posts with standard  $\frac{3}{4}$ -inch spacing; a ground terminal is provided, adjacent to one of the output terminals.
- Power Supply:** Unlike most instruments of the Unit line, the power supply is built into the instrument; 115 volts, 40-60 cycles; power consumption is about 16 watts.
- Accessories Supplied:** Spare fuses; the power cord is integral with the unit.
- Tube:** One 117N7-GT, which is supplied with the instrument.
- Mounting:** Aluminum panel and sides finished in black-crackle lacquer. Aluminum dust cover finished in clear lacquer. Relay-rack adaptor panel available.
- Dimensions:** (Height)  $5\frac{3}{4}$  x (width) 5 x (depth)  $6\frac{1}{4}$  inches, over-all, not including power-line connector cord.
- Net Weight:**  $4\frac{1}{2}$  pounds.

Type	Code Word	Price
1214-A	ALLAY	\$68.00
480-P4U1	UNIPANARCH	9.00

PATENT NOTICE. See Note 2, page viii.



## TYPE 1211-B UNIT OSCILLATOR

**USES:** This oscillator is a compact, inexpensive, general-purpose, radio-frequency power source of excellent frequency stability. It is recommended for use with the TYPES 916-AL and 1606-A R-F Bridges and the TYPE 1601-A VHF Bridge. It can be swept automatically with either the TYPES 908-P and 908-R Dial Drives or the TYPE 1750-A Sweep Drive (pages 200-203), for frequency-response measurements that can be observed on an oscilloscope or plotted on a recorder. The TYPE 1263-A Amplitude Regulating Power Supply (page 148) will hold the output amplitude constant over the entire frequency range.

**DESCRIPTION:** The 100:1 frequency span of 0.5 to 50 Mc is achieved in two bands by varying simultaneously the capacitance and inductance of the Hartley-type tuned circuit. An inductance variation of about 4:1 is obtained by two sickle-shaped cores carried on the tuning capacitor shaft. One core is made of powdered magnetic material and is centered within the tuned-circuit inductance coil at the low frequency end. As the tuning capacitance is reduced, this core is withdrawn and replaced by the second core made of aluminum.

The oscillator can be externally amplitude modulated by superimposing an audio-frequency voltage on the plate supply.

The output circuit is inductively coupled to

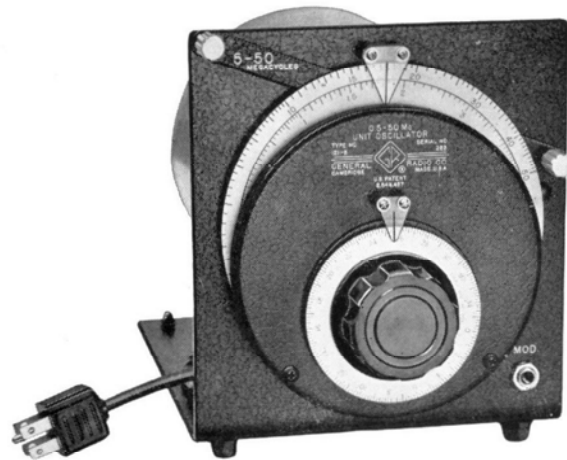

the oscillator and includes a variable voltage divider.

**FEATURES:** ➤ Compact unit design.

➤ Two ranges, 0.5 to 5 Mc and 5 to 50 Mc.

➤ Logarithmic calibration of the main frequency dial, with a slow-motion dial calibrated in frequency increments of approximately 0.2% per division.

➤ Power output of at least 200 milliwatts over the entire range, with considerably more over the lower band.

### SPECIFICATIONS

**Frequency Range:** 0.5 to 50 Mc in two ranges.

**Frequency Calibration Accuracy:**  $\pm 2\%$  at no load.

**Frequency Controls:** Two-position range switch. Six-inch slow-motion dial with logarithmic calibration in frequency increments of 0.2% per dial division.

**Output System:** Output is available at a coaxial connector at the rear of the instrument. An adjacent ground terminal also permits connection by means of a TYPE 274-MB Double Plug. Output is controlled by a small dial, calibrated in arbitrary units.

**Output Power:** At least 200 milliwatts into a 50-ohm load for the high range. Approximately 2 watts for the 0.5-5 Mc range.

**Modulation:** Direct amplitude modulation over the audio-frequency range can be obtained with an external audio oscillator that must be capable of carrying the d-c plate current of the TYPE 1211-B. Modulation voltage is introduced at a telephone jack located on the front panel. Input impedance is approximately 8000 ohms; 45 volts input produces 25% modulation with 3% distortion. For modulation with negligible fm (above 20 Mc) use the TYPE 1000-P6 Crystal Diode Modulator (page 99).

**Power Supply Requirements:** 300 volts at 50 ma dc, 6.0 volts at 0.75 a, a-c or d-c. The TYPE 1203-A, 1201-A, or 1202-A Unit Power Supply (pages 144-146) is recommended. For constant output amplitude, use the TYPE 1263-A Amplitude Regulating Power Supply (page 148).

**Tube Complement:** One TYPE 5763 Miniature VHF Beam Power Amplifier.

**Mounting:** The oscillator is mounted on an aluminum casting, and is shielded with a spun-aluminum cover. The assembly is mounted on an L-shaped panel and chassis, finished in black-crackle lacquer.

**Accessories Supplied:** TYPE 874-R22 Patch Cord, TYPE 874-PB58 Panel Connector, TYPE 874-Q2 Adaptor, and a multipoint connector.

**Accessories Available:** Modulator, TYPE 1214-A Unit Oscillator (page 112); for fm-free modulation, TYPE 1000-P6 Crystal Diode Modulator (page 99); for v-h-f measurements, the TYPE 874 Coaxial Elements (page 45); for sweep applications, motor drives as listed on pages 200 to 203.

**Dimensions:** 7 x 8 x 12 inches over-all.

**Net Weight:** 11½ pounds.

Type		Code Word	Price
1211-B	Unit Oscillator * (0.5-50Mc).....	ATLAS	\$265.00
1203-A	Unit Power Supply.....	ALIVE	40.00
480-P4UC1	Relay Rack Panel (mounts both oscillator and power supply) .....	UNIPANGOLA	11.00

\*PATENT NOTICE. See Note 4, page viii.



## TYPE 1210-B UNIT R-C OSCILLATOR



TYPE 1210-B Unit R-C Oscillator shown permanently connected to TYPE 1203-A Unit Power Supply.

**USES:** This compact, inexpensive oscillator, with its available accessories, offers outstanding performance per dollar and per cubic inch of space. Its general utility and versatility cannot be matched by any other oscillator in its price class.

It can be used as:

A power source for sine-wave measurements at audio, ultrasonic, and low-radio frequencies.

A source of square waves for network steady-state and transient response measurements at audio, ultrasonic, and low-radio frequencies.

A sine-wave or square-wave modulator for r-f oscillators and standard-signal generators and as a square-wave trigger for pulse generators.

A swept oscillator, with the 908-P1 Synchronous Dial Drive or the TYPE 907-R X-Y Dial Drive and a graphic recorder, for directly plotted amplitude-frequency characteristics.

A swept oscillator with the 908-P2 Synchronous Dial Drive and the TYPE 1210-P1 Detector and Discriminator, for displaying amplitude-frequency characteristics on a cathode-ray oscillograph.

**DESCRIPTION:** The frequency of the oscillator is determined by an R-C network. A fast-

responding A-V-C system is used to hold the amplitude of oscillation constant in spite of changes in frequency or line voltage.

The output system of the oscillator provides three different outputs: a low-impedance, low-voltage, sine-wave output from a cathode-follower-type amplifier; a high-impedance, high-voltage, sine-wave output from a cathode-follower-driven, triode amplifier; and a square-wave output from a Schmitt circuit.

When the oscillator is to be permanently mounted in the laboratory, it becomes a rack-mounted instrument in combination with the TYPE 480-P4U3 Relay-Rack Panel.

**FEATURES:** > Very wide frequency range — audio, supersonic, and radio frequencies.

- > Sine- and square-wave output
- > Small size
- > Inexpensive
- > Sweepable
- > Fast responding AVC system
- > Calibrated output control
- > Output constant with frequency
- > High output voltage
- > Precision frequency-control dial
- > Compact and rugged

### SPECIFICATIONS

**Frequency Range:** 20-500,000 c in 5 ranges: 20-200, 200-2000, 2000-20,000, 20,000-200,000, and 50,000-500,000 c.

**Frequency Controls:** Range selection switch and 4-inch precision gear-driven dial. Dial has two scales, 2-20 and 50-500, and is geared to a slow-motion knob that covers each decade in about  $4\frac{1}{2}$  turns.

**Frequency Accuracy:**  $\pm 3\%$

**Output Control:** Logarithmic, calibrated 0-50 db.

**Output System:** 3-position panel switch for square-wave, sine-wave low-impedance, or sine-wave high-impedance output.

**Low-Impedance Output:** (for loads of 500 ohms and higher) 0-7 v, constant within  $\pm 1$  db up to 200 kc;



internal output impedance 50 ohms; no-load distortion less than 1% from 200 c to 10 kc, less than 1.5% over entire frequency range. Hum is at least 60 db below output voltage level.

**High-Impedance Output:** (for loads of 10,000 ohms and higher) 0-45 v, constant within  $\pm 1$  db from 200 c to 200 kc; distortion less than 5% from 200 c to 200 kc, no load (reduced under load). Internal output impedance 12,500 ohms. Hum at least 50 db below maximum output voltage level.

**Square-Wave Output:** 0-30 v peak to peak; rise time approximately  $\frac{1}{4}$   $\mu$ sec; overshoot approximately 1%; hum at least 60 db below output voltage level; internal output impedance 2,500 ohms.

**Output Terminals:** Two jack-top TYPE 274 binding posts, one grounded to panel.

**Tube Complement:** One each 6BQ7-A, 0B2; two 12AU7's.

**Power Requirements:** 6.3 v ac or dc at 1 amp; 300 v dc at 50 ma.

**Power Supply Recommended:** TYPE 1203-A Unit Power Supply for operation from 115 v, 50-60 cycles.

The TYPE 1201-A Unit Regulated Power Supply will provide a slight improvement in frequency stability on the highest frequency range. TYPE 1202-A Unit Vibrator Power Supply can be operated from either a 6 or 12 v storage battery or from 115 v, 50-60 cps power line. A matching multipoint connector is supplied for connecting other power supplies.

**Mountings:** Black-crackle finish aluminum panel and sides; aluminum cover finished in clear laquer. The TYPE 480-P4U3 Panel is available for use with oscillator and power supply combination.

**Accessories Available:** For higher output (3 watts) use TYPE 1206-B Unit Amplifier (page 5); for oscilloscope display, TYPE 908-P2 Synchronous Dial Drive (page 202) and 1210-P1 Detector and Discriminator (see below); for graphic recording, TYPE 907-R X-Y Drive or TYPE 908-P1 Synchronous Dial Drive (page 202).

**Dimensions:** 10 $\frac{1}{2}$  (width) x 5 $\frac{3}{4}$  (height) x 7 inches (depth) over-all.

**Weight:** 6 $\frac{1}{4}$  lb.

Type		Code Word	Price
1210-B	Unit R-C Oscillator.....	ABAFT	\$165.00
1203-A	Unit Power Supply.....	ALIVE	40.00
480-P4U3	Relay-rack Panel (for mounting both 1210-B and 1203-A in one panel).....	UNIPANCART	10.00

PATENT NOTICE. See Note 9, page viii.

## TYPE 1210-P1 DETECTOR AND DISCRIMINATOR

Used with the TYPE 1210-B Unit R-C Oscillator and the TYPE 908-P2 Synchronous Dial Drive, the TYPE 1210-P1 Detector and Discriminator will provide the necessary voltages for convenient, cathode-ray oscillograph display of the frequency response of a network.

The instrument provides voltage proportional to frequency for the X-axis of an oscilloscope, an adjustable test voltage derived from the oscillator, and an output voltage, proportional to the amplitude of the output voltage of the network under test, for the Y-axis of the oscilloscope.

No additional power supply is required for this unit.

### SPECIFICATIONS

**Frequency Range:** Approximately linear sweep output voltage from 200 c to 500 kc in seven ranges = 200-600 c, 200-2000 c, 600-6000 c, 2-20 kc, 6-60 kc, 20-200 kc, and 50-500 kc.

**Sweep Output Voltage:** 2 v open circuit per frequency decade, with maximum output from TYPE 1210-B Unit R-C Oscillator.

**Sweep Output Impedance:** Depends on delay setting, varies from 700 k $\Omega$  to 3.2M $\Omega$ .

**Test Voltage:** 10 v, with maximum output from TYPE 1210-B Unit R-C Oscillator. Source impedance about 6500 ohms for maximum output setting of Test Voltage Control, lower for output less than maximum.

**Detector Impedance:** About 200 k $\Omega$  shunted by 20  $\mu$ f at 1 kc; decreasing to 120 k $\Omega$  shunted by 10  $\mu$ f at 500 kc.

**Crystal Diodes:** 1N34A (five), 1N305 (three)

**Terminals:** Jack-top binding posts mounted on  $\frac{3}{4}$ -in. spacing.

**Mounting:** Black-crackle-finish aluminum panel and sides. Aluminum cover finished in clear lacquer. Provision made for attaching to TYPE 1210-B Unit R-C Oscillator by means of 10-32 screw, with wing nut. Relay-rack panel TYPE 480-P4U1 available for use with Detector and Discriminator.

**Dimensions:** 5 $\frac{1}{8}$  inches (width) x 5 $\frac{3}{4}$  inches (height) x 6 $\frac{3}{8}$  inches (depth) over-all.

**Weight:** 2 $\frac{1}{2}$  pounds.



Type		Code Word	Price
1210-P1	Detector and Discriminator.....	DUDAD	\$75.00
480-P4U1	Relay-rack Panel.....	UNIPANARCH	9.00



## V-H-F and U-H-F UNIT OSCILLATORS

**USES:** These oscillators are compact, low-priced units that cover wide frequency ranges with single-dial control. Adequate power, coupled with good shielding, makes these oscillators well suited to drive bridges, slotted lines, and other impedance-measuring equipment. Their convenient adaptability makes them useful as general-purpose instruments for the laboratory, and their small size, simplicity, and low cost assure their usefulness in production applications.

Output terminals are TYPE 874 Coaxial Connectors for convenient connection to General Radio measuring equipment and the wide variety of Coaxial Elements described in the section starting on page 125. Adaptors that permit interconnection with other standard coaxial connectors are described in the coaxial section (page 45).

Adaptability to sweeping techniques is another application of these instruments. They may be swept over fixed ranges of dial arc at various speeds by means of the drives listed on pages 199 to 203.

Combined with TYPE 874 Coaxial Elements, these oscillators can be used as building blocks to assemble a wide variety of systems that would otherwise require more specialized and expensive equipment.

used in place of the stub. To provide the proper impedance match for maximum power transfer of the unit oscillator, a TYPE 874-LA Adjustable Line is required. In the microvolt region the shielding of this arrangement is not sufficient for accurate measurements.

### MODULATION

Amplitude modulation over the audio range can be obtained by superimposing a-f voltage on the plate supply. The audio source must be capable of carrying the d-c plate current of the oscillator. The TYPE 1214-A Unit Oscillator is recommended as a modulator. Incidental fm inherent in this system is of the order of 0.01% for 30% am in the lower part of the tuning range and increases rapidly at the high-frequency end.

With the TYPE 1000-P7 Balanced Modulator (page 100), the output of the Unit Oscillators (above 60 Mc) can be modulated up to 100% with sinusoidal or pulse waveforms, and rise times as short as 0.02 microsecond can be obtained.

### TV TEST GENERATOR

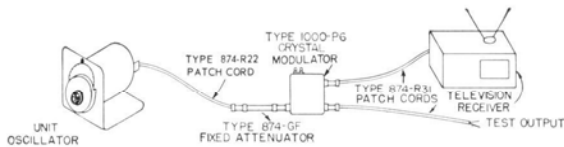

A convenient source of television signals over the entire carrier-frequency range of the oscillator is available with another combination. A Unit Oscillator, a TYPE 1000-P6 Crystal Diode Modulator and a TYPE 874-G20 20-db Fixed Attenuator is the required combination. The necessary video modulation can be obtained from the video amplifier in a standard television receiver tuned to a local station. Since the modulator is separated from the oscillator by an attenuator pad, amplitude modulation free from incidental frequency modulation is obtained.

### POWER SUPPLY

Plate and heater power can be furnished for most applications by the TYPE 1203-A Unit Power Supply. For applications where a well-regulated power supply with lower hum voltages may be desirable, the TYPE 1201-A Unit Regulated Power Supply is available.

### MOUNTING

The oscillators are supported by L-shaped brackets that take up little bench space. All components are mounted on a flat base casting that carries the supply line filters on one side, and the tuned circuit on the other. The tuned circuit is enclosed in a cylindrical shield. Relay-rack adaptor panels are available.

### CONVERTER AND DETECTOR

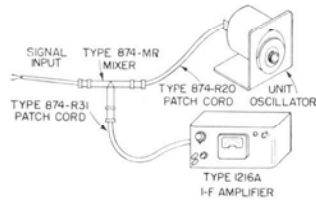

A Unit Oscillator and a TYPE 874-MR Mixer-Rectifier Detector can be combined to form a frequency converter. The TYPE 1216-A I-F Amplifier can be used with this combination to form a sensitive detector for VHF and UHF signals. This arrangement, called the TYPE DNT Detector (see page 69), is an excellent null detector for the TYPE 1601-A VHF Bridge or the TYPE 1602-B UHF Admittance Meter.

### SIGNAL GENERATOR

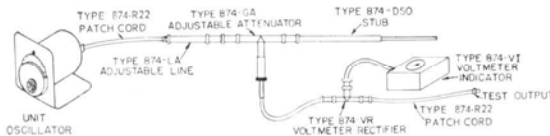

The combination of unit oscillator, output voltmeter, and attenuator is a signal generator. Below 300 Mc a TYPE 874-WN Short-Circuit Termination is

## GENERAL SPECIFICATIONS

**Output System:** Short coaxial line with coupling loop at one end, and a TYPE 874 Coaxial Connector on the other. The coupling loop can be rotated or moved axially to obtain less than full power output if desired. Maximum power can be delivered to load impedances normally encountered in coaxial systems.

**Mounting:** Oscillator is mounted in an aluminum casting, and is shielded with a spun-aluminum cover. The assembly is mounted on an L-shaped panel and chassis.

**Accessories Supplied:** TYPE 874-R22 Patch Cord, TYPE 874-C58 Cable Connector, TYPE 874-PB58 Panel Con-

necter, TYPE CDMS-18-4 Multipoint Connector and TYPE CDMP-22 Telephone Plug.

**Accessories Available:** TYPE 1000-P6 Modulator and TYPE 1000-P7 Balanced Modulator (pages 99 and 100); TYPE 1214-A Unit Oscillator (page 112) and TYPE 1210-B Unit R-C Oscillator (page 114), as modulating sources; Unit Power Supplies (pages 144-146), TYPE 874 Coaxial Elements (page 45); TYPES 908-P, 907-R and 908-R Dial Drives and TYPE 1750-A Sweep Drive for sweep applications (pages 199-203); TYPE 1263-A Amplitude Regulating Power Supply (page 148) for constant amplitude control (cannot be used with 1208-B).





V-H-F and U-H-F UNIT OSCILLATORS

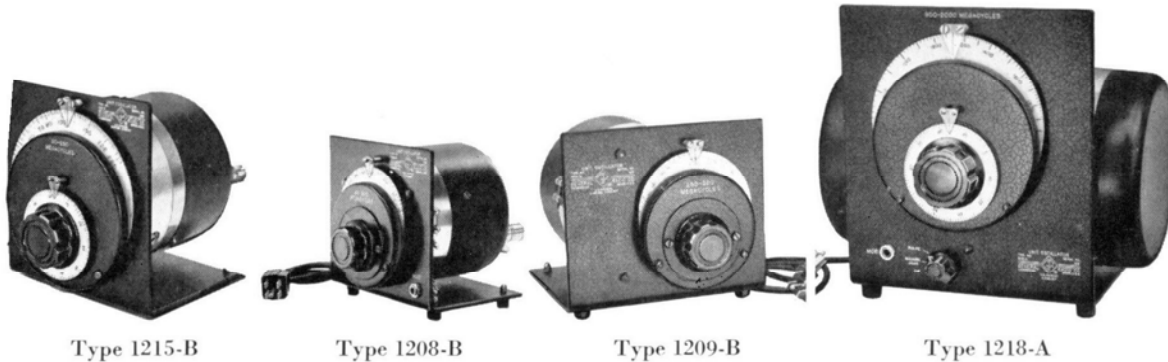

(see also Type 1220-A Unit Klystron Oscillator, page 118)

Oscillator Type No.	Type 1215-B	Type 1208-B	Type 1209-B	Type 1218-A
Frequency Range	50-250 Mc	65-500 Mc	250-920 Mc	900-2000 Mc
Tuned Circuit	Semi-Butterfly with no sliding contacts	Sliding Contact	Butterfly, with no sliding contacts	Line sections with sliding contacts
Frequency Control	6-inch TYPE 908 dial with calibration over 140 degrees. Precision drive.	4-inch TYPE 907 dial with calibration over 270 degrees. Precision drive.	4-inch TYPE 907 dial with calibration over 270 degrees. Precision drive.	6-inch TYPE 908 dial with calibration over 200 degrees. Precision drive.
Frequency Calibration Accuracy	±1% at no load	±2%	±1%	±1%
Warm-up Frequency Drift	0.4%	0.5%	0.2%	0.1%
Output Power Into 50-Ohm Load at any Frequency	80 mw	100 mw; 500 mw at center of range	200 mw	200 mw
Modulation	AM at audio frequencies. 25% at 50 volts. Input 15,000 ohms.	AM at audio frequencies. 30% at 40 volts. Input impedance 8,000 ohms.		AM (sine and square wave), pulse modulation and frequency variation.
Sweep Drive	With TYPES 908-P1 and P2 Synchronous Dial Drives, TYPE 907-R and 908-R X-Y Dial Drives, or TYPE 1750-A Sweep Drive — Pages 199 to 203			
Amplitude Control	With TYPE 1263-A Power Supply (see page 148)	Not Recommended	With TYPE 1263-A Power Supply (see page 148)	With TYPE 1263-A Power Supply (see page 148)
Power Supply Required	300-volts d-c at 25 ma and 6.3 volts a-c at 0.3 ampere. Unit Power Supplies, TYPE 1203-A, 1201-A, and 1202-A are recommended. See pages 144 to 146.	300-volts d-c at 40 ma and 6.3 volts a-c at 0.9 ampere.	300-volts d-c at 40 ma and 6.3 volts a-c at 0.4 ampere.	300-volts d-c at 30 ma and 6.3 volts, 0.3 ampere a-c.
Tube	AT7 Miniature Twin-Triode	2C43 Lighthouse Triode	RT-434 Disc Seal Triode	5675 UHF Medium-mu Pencil Triode
Over-all Dimensions	7 x 8 x 9 1/2"	6 1/4 x 6 1/4 x 8 1/4"	7 x 6 1/4 x 9 1/4"	12 1/2 x 10 3/8 x 9 1/2"
Net Weight	7 1/2 lbs.	5 1/2 lbs.	6 1/4 lbs.	14 3/4 lbs.
Code Word	ADOPT	AMEND	AMISS	CARRY
Price	\$190.00	\$200.00	\$235.00	\$465.00

RELAY RACK ADAPTOR PANELS

For Oscillator Only				TYPE 480-P7U1
For Oscillator and TYPE 1203-A (or TYPE 1201-A) Power Supply	480-P5UC1	480-P4UC1	480-P4UC2	
Code Word	UNIPANGOLF	UNIPANDOCK	UNIPANFORT	UNIPANHUMP
Price	\$15.00	\$11.00	\$11.00	\$11.00



TYPE 1220-A UNIT KLYSTRON OSCILLATOR



Because of its relatively high output, low cost, small size and rugged construction, it is equally useful in the laboratory, on the production line, and in classroom demonstrations. It is an excellent source for slotted-line measurements of impedance and VSWR, measurements of bandwidth, and attenuation measurements on cables, lines, and pads.

**DESCRIPTION:** This instrument includes an adjustable, regulated source of repeller voltage, a Schmitt squaring circuit, a 1000-cycle RC oscillator, and a socket for a reflex klystron tube. Klystron cathode current is furnished by an external Unit Power Supply.

Eight plug-in klystrons cover the frequency range. The oscillator is listed with each single klystron; additional klystrons can be ordered as desired.

Klystron frequency can be adjusted readily by a screw adjustment at the rear.

**USES:** The Unit Klystron Oscillator generates frequencies between 2700 and 7400 megacycles. It can generate fixed frequencies or swept frequencies and can be amplitude modulated with either square waves or pulses, with very low incidental fm.

SPECIFICATIONS

**Frequency Range:** Depends on klystron tube used (see table below); frequency range of any unit can be changed to that of any other by inserting the appropriate klystron tube.

**Frequency Calibration:** None.

**Amplitude Modulation:**

*Internal:* 1-ke square wave, adjustable  $\pm 15$  cycles.

*External:*

Square wave: 50 c to 200 kc; sine or square-wave modulating signal of at least 15v rms required — TYPE 1210-B R-C Oscillator recommended.

Pulse: 1 to 10,000  $\mu$ s duration, less than 0.2  $\mu$ s rise and fall time, 50 c to 200 kc repetition rate; at least 20v peak pulse voltage required — TYPE 1217-A Unit Pulser recommended.

Frequency Modulation: at least 15 Mc excursion ob-

tainable with less than 3 db change in output; — at 60 c, an rms input of the order of 10v is suitable.

**Output Connector:** 50-ohm TYPE 874 Coaxial Connector. Adaptors to other connector types available. (See page 62).

**Tube Complement:** Klystron, as specified, for TYPES 1220-A1 through A-8; one 6AB4, one 5963, two OA2.

**Accessories Required:** Unit Power Supply; TYPE 1201-A Unit Regulated Power Supply recommended for high stability and minimum incidental fm (page 145).

**Accessories Recommended:** Fixed attenuator pad for isolating oscillator from load (page 57); TYPE 874-VQ or -VR for facilitating tuning adjustments (page 49).

**Dimensions:** 9 $\frac{7}{8}$  x 5 $\frac{3}{4}$  x 6 $\frac{1}{4}$  inches, not including plugs, knobs, and terminals.

**Net Weight:** 6 pounds, with klystron.

Type	Klystron Oscillator with Klystron, for	Nominal Output in Milliwatts	Code Word	Price
1220-A1	2700-2960 Mc.....	100	KAWUN	\$254.65
1220-A2	2950-3275 Mc.....	90	KATOO	272.90
1220-A3	3400-3960 Mc.....	90	KATRE	265.75
1220-A4	3840-4460 Mc.....	75	KAFOR	312.15
1220-A5	4240-4910 Mc.....	100	KAFIN	261.45
1220-A6	5100-5900 Mc.....	80	KASIX	301.45
1220-A7	5925-6450 Mc.....	100	KASET	272.90
1220-A8	6200-7425 Mc.....	90	KALOC	272.90
1220-A	Without Tube.....		KANOT	205.00
1201-A	Unit Power Supply.....		ASSET	80.00

Type		Code Word	Price
726-C	Klystron, 2700-2960 Mc.....	KLYSTRONAY	\$49.65
6043	Klystron, 2950-3275 Mc.....	KLYSTROBEE	67.90
2K29	Klystron, 3400-3960 Mc.....	KLYSTROSEE	60.75
2K56	Klystron, 3840-4460 Mc.....	KLYSTRODEE	107.15
2K22	Klystron, 4240-4910 Mc.....	KLYSTRONEE	56.45
6115	Klystron, 5100-5900 Mc.....	KLYSTRONEF	96.45
QK404	Klystron, 5925-6450 Mc.....	KLYSTROGEE	67.90
5976	Klystron, 6200-7425 Mc.....	KLYSTROJAY	67.90

All klystron tubes except the 6043 are designed for relatively infrequent tuning. The oscillator will also operate with the TYPE 2K25 Klystron (8550-9660 Mc), and TYPE 2K26 (6250-7060 Mc).

# PULSE AND NOISE GENERATORS

## PULSE AND TIME-DELAY GENERATORS

The rapid expansion of the electronics industry in the past fifteen years has been due as much to the rise of new fields as to the expansion of the older field of communications. Radar, long-distance navigation systems, electronic computation, and television are new areas in which high-speed switching and time measurements are fundamental tools. Starting with the development of the TYPE 869-A Pulse Generator for the Radiation Laboratory at the Massachusetts Institute of Technology in 1942, The General Radio Company has been continuously engaged in development work on pulse systems to provide science and industry with the best in equipment for the production of pulse waveforms for general laboratory applications.

Several quantities are important to the prospective purchaser of a pulse generator. The particular application will, of course, dictate which ones are of paramount importance:

- (1) The rise and decay times of the pulse
- (2) The range of time duration of the pulse
- (3) The range of pulse repetition rates
- (4) The peak pulse power
- (5) The output impedance of the generator
- (6) The maximum possible duty ratio (pulse duration divided by pulse repetition period.)
- (7) Stability and accuracy of these quantities.

In an ideal pulse generator, the pulse would rise and fall instantaneously, and the duration could range from zero to infinity in time. There should, of course, be no limit on repetition frequency, and thus an ideal duty-ratio figure would be unity.

Practical pulse generators must necessarily fall short of these ideal criteria. The transition times are generally limited by the bandwidth of the switch, mechanical or electronic, producing the pulse, and by the output coupling system connecting it to the load. Maximum repetition frequency is limited by the recovery transients of the pulse timing circuits and/or the maximum permissible duty ratio. The available pulse power is, in general, only limited by economic considerations of power supply and the output tubes, which must handle the average pulse power.

Under these constraints then, it is hardly surprising that no one pulse generator can adequately fill all possible applications. It is the intention of the General Radio Company to provide the industry with a line of pulse sources to meet every practical laboratory application.

The TYPE 1217-A Unit Pulser, with a large adjustment range of repetition frequency and pulse duration and a self-contained oscillator, is an economical pulse source for low-power applications and for systems of up to 5-Mc bandwidth. It is excellent for such diverse applications as amplifier square-wave testing, studies of the transient response of networks, and as a pulse-frequency source for the driving of high-power pulse sources.

The TYPE 1219-A Pulse Amplifier can be driven by any convenient source of pulses to produce an output pulse of current ranging up to 0.6 ampere. It provides adequate energy to drive pulsed oscillators and will develop up to 30 volts in a 50-ohm load. Maximum duty ratio is 50%, which makes the unit useful for the production of high-energy square waves. Rise and decay times as short as 0.03 microsecond can be produced. Brief triggers at a low impedance can be produced for testing the performance and resolution of trigger circuits and delay lines in the megacycle range.

The TYPE 1391-A Pulse, Sweep, and Time-Delay Generator is the latest and most versatile addition to our line of pulse instruments. It is, we believe, the most versatile pulse instrument in a single package available anywhere. The rise and decay times for the push-pull output are both .025 microsecond, and the pulse duration ranges from .05 microsecond to 1.1 seconds. There are no duty-ratio restrictions even though pulse current of .15 ampere is available to the load. Switched internal loads of 50 to 600 ohms are available.

An internal, wide-range, precision time-delay generator of high resolution and stability produces a delayed trigger pulse ranging from 1 microsecond to 1.1 seconds; coincidence circuitry is included for easy recalibration and complex synchronization. A wide variety of switching and external connection possibilities make this generator applicable to almost any conceivable laboratory application where pulses and time delays are desired.

## RANDOM NOISE GENERATOR

The use of "white" noise as a tool in the measurement and test of electronic systems is another important modern development. The concept of wide-band testing, as contrasted to point-by-point measurements, saves valuable engineering time and often leads to more significant results. The TYPE 1390-A Random Noise Generator, described on page 124, is a well-designed source for these tests at frequencies between 20 c and 5 Mc.



## TYPE 1391-A PULSE, SWEEP, AND TIME-DELAY GENERATOR

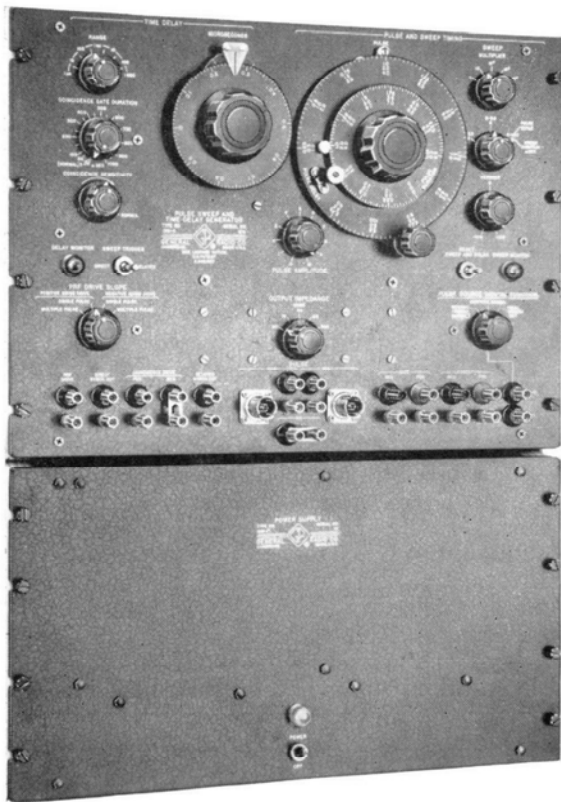

**USES:** The Type 1391-A Pulse, Sweep, and Time-Delay Generator performs, individually and in combination, all the functions described by its title and performs them all well; its excellent performance results from a minimum number of compromises in design. Its wide ranges and complete flexibility of circuit interconnection make it a highly satisfactory pulse generator for laboratories engaged in time-domain measurements and waveform synthesis.

The transition times of the output pulses are compatible with most present-day oscilloscopes. The internal sweep circuit makes it possible to deflect an inexpensive oscilloscope by direct connection to the deflecting plates to monitor the output pulse.

Among its many applications are measurement and testing in the fields of

Echo ranging	Computers
Radio navigation	Telemetry
Television	Physiological research

**DESCRIPTION:** The Pulse, Sweep, and Time-Delay Generator consists of the following major circuit groups: (1) input synchronizing circuits, (2) delay and coincidence circuits, (3) sweep circuits, and (4) pulse-timing and pulse-forming circuits.

The input circuits will accept almost any input waveform and provide a trigger pulse to start the operation

of the sweep and delay circuits. These input circuits consist of an input amplifier, Schmitt trigger circuit, pulse-forming stages, and an output cathode follower.

The delay circuit system is started by a trigger pulse generated by the input circuits. It consists of a bi-stable multivibrator controlling a pentode sweep generator. The sweep-generator output feeds an amplitude selector, which resets the bistable circuit when the sweep reaches an amplitude determined by a ten-turn delay potentiometer. The delayed trigger pulse so generated starts the coincidence circuit.

The coincidence system comprises: (1) a monostable multivibrator producing a pulse adjustable in duration from 3 to 1000  $\mu$ sec, (2) a coincidence amplifier stage, (3) trigger pulse-forming stages, and (4) an output cathode follower to produce the delayed output trigger pulse. Normally the leading edge of the 3- to 1000- $\mu$ sec gate causes the coincidence amplifier stage to produce the delayed trigger pulse. Increasing the bias on the coincidence stage converts it to an "and" circuit, which requires the time coincidence of the 3- to 1000- $\mu$ sec gate and an externally produced pulse to produce the delayed synchronizing pulse. This system permits multiple pulsing, delay-circuit calibration, and other time-selection operations.

The sweep circuit consists of a bistable control circuit, bootstrap linear sweep generator, amplifiers and cathode followers for the positive and negative output phases, and a push-pull sweep-gate output circuit capable of deflecting a 5-inch oscilloscope.

The positive sweep times the pulse. Two amplitude selectors start and stop the pulse-forming circuits at arbitrary sweep voltages. This system permits accurate pulse timing based only on sweep linearity and accuracy.

The pulse-generating circuits consist of a bistable multivibrator, push-pull pulse amplifiers, and output stage. The output stage produces 150-milliampere current pulses into built-in load resistors ranging from 50 to 600 ohms. The d-c component is retained in the output pulse, so that pulses of any duration can be produced without ramp-off effects.

Utmost flexibility is provided either by switching or by terminal connections to the various circuit groups. For example:

- (1) The sweep can be started either delayed or by the direct trigger.
- (2) The pulse can be timed by the sweep circuit, by the delay circuit, or by externally generated pulses.
- (3) The accurately timed "start" and "stop" pulses derived from the sweep can be used to time external systems.

The generator is triggered from an external source, and its performance is independent of the source waveform. Power supply is mounted on a separate panel. Both relay-rack and bench models are available.

**FEATURES:** ➤ Extremely wide ranges of pulse duration and delay.

- No duty-ratio restrictions.
- Low jitter — high accuracy.
- Variable output impedance, 0-600 ohms.
- Pulse-forming and delay circuits stable against hum and line transients.
- Coincidence circuitry makes possible multiple pulsing and time selection.
- Push-pull pulse, sweep, and sweep-gate circuits.

### SPECIFICATIONS

**Input Synchronizing Signal:** Signals of almost any shape will trigger the input timing circuits. Average value must be approximately 0.2 volt, minimum.

Typical input signal minimum amplitudes are:

- (1) Sine wave 0.2 volt, rms.
- (2) Square waves 0.5 volt, peak-to-peak.
- (3) Brief positive pulse 10 volts, peak-to-peak.\*
- (4) Brief negative pulse 10 volts, peak-to-peak.\*

\* Internal screwdriver adjustment permits increasing trigger circuit sensitivity for either positive or negative pulses.

**Direct Synchronizing Pulse:**

Polarity-positive amplitude: 75 volts peak-to-peak.  
Duration: ( $\frac{1}{2}$  amplitude) 1  $\mu$ sec.  
Output Impedance: 600 ohms.  
Repetition Rate: Amplitude constant to 300 kc; down 20% at 500 kc.

**Time-Delay Circuit:**

**Range:** 1.0  $\mu$ sec to 1.1 sec in six ranges.

**Delay Dial Calibration:** 1.00 to 11.00 in 1000 divisions.

**Delay Dial Resolution:** 1 part in 8800.

**Accuracy:** Absolute,  $\pm 2\%$  of full scale, or  $\pm 3\%$  of scale reading + 0.05  $\mu$ sec, whichever is smaller; incremental delay,  $\pm (1\% + .05 \mu\text{sec})$ .

**Maximum PRF:** 400 kc.

**Duty Ratio Effects:** Less than 2% error in delay for duty ratios up to 60%, at the low end of each range, and up to 90% at the high end of each range; proportional effects between.

**Delayed Synchronizing Pulse Characteristics:** Positive, 60 v, 1.0- $\mu$ sec half-amplitude duration, 600 ohm cathode-follower output.

**Stability:**

	Low End of Dial	High End of Dial
Time Jitter	1:10,000	1:50,000
10% Line Change	2:1000	2:10,000
Sudden 10% Line Transient	3:1000	3:10,000

**Coincidence Circuits:**

**Gate Duration:** 3 to 1000  $\mu$ sec.

**Gate Accuracy:**  $\pm 15\%$  or  $\pm 1 \mu$ sec, whichever is larger.

Coincidence driving circuit will accept either positive or negative input pulses. Source impedance should be low, have rise time less than 0.2  $\mu$ sec. Amplitudes between 5 and 20 volts are acceptable for negative pulses, and between 10 and 100 for positive pulses.

**Sweep Circuit:**

**Sweep Duration:** 3, 6, 12  $\mu$ sec with 5-decade multiplier.

**Sweep Linearity:** Determined by the accuracy of pulse timing. On longer ranges, where time delay effects are absent, the linearity is better than 1%.

**Sweep Amplitude:** Push-pull, each phase, 135 volts  $\pm 10\%$ .

**Sweep Gate Amplitude:** Push-pull, each phase 40 volts  $\pm 10\%$ . Negative and positive sweeps and the positive sweep gate are cathode-follower output circuits with a 1- $\mu$ f coupling capacitor.

**Duty Ratio and Repetition Rate Effects:** Maximum repetition rate, 3  $\mu$ sec sweep, 250 kc.

Range      Maximum Frequency for 5% Error in Sweep Slope

Sweep Time	3 $\mu$ sec	6 $\mu$ sec	12 $\mu$ sec
x 1	150 kc	100 kc	60 kc
x 10	160 kc	12 kc	7 kc
x 10 <sup>2</sup>	1.6 kc	1.2 kc	700 c
x 10 <sup>3</sup>	160 c	120 c	70 c
x 10 <sup>5</sup>	16 c	12 c	7 c

Type		Code Word	Price
1391-AM	Cabinet Model (incl. Power Supply).....	EDIFY	\$1745.00
1391-AR	Relay-Rack Model (incl. Power Supply)...	EBONY	1745.00

PATENT NOTICE. See Notes 2 and 4, page viii.

**Pulse Generating Circuit:**

**Pulse Duration:** (Timed by sweep) 0.05 to 2.5, 0.05 to 5.0 and 0.05 to 10.0 between half amplitude points, with decade multipliers to a maximum of 100,000  $\mu$ sec. Pulse length can be extended to 1.1 seconds if pulse is timed by delay circuit.

**Pulse Duration Accuracy:** After sweep calibration,  $\pm (1\% + 0.05 \mu\text{sec})$ .

**Pulse Position Accuracy:** 0.5  $\mu$ sec  $\pm 1\%$  of dial reading.

**Pulse Rise Time:** Depends on output impedance chosen. Into a terminated 50-ohm coaxial line, it can vary from 0.025  $\mu$ sec by  $\pm 0.01 \mu$ sec. The following are typical (0.1  $\mu$ sec pulse as measured on oscilloscope; rise time of vertical amplifier 0.006  $\mu$ sec):

Impedance	Positive Pulse		Negative Pulse	
	Rise $\mu$ sec	Decay $\mu$ sec	Rise $\mu$ sec	Decay $\mu$ sec
Terminated Coax 50 ohms	0.03	0.015	0.02	0.03
15 $\mu$ f Probe 72 ohms	0.03	0.025	0.02	0.03
95 ohms	0.03	0.025	.025	0.03
150 ohms	0.03	0.03	.025	0.03
600 ohms	0.05	0.05	0.04	0.05

**Pulse Shape:** Overshoots and other defects are less than 5% of pulse amplitude when the pulse generator is correctly terminated. Pulse ramp-off does not exist, owing to direct coupling of output circuits.

**Pulse Duty Ratio:** Push-pull circuit with unity duty ratio possible.

**Output Impedance,  $Z_0$ :** 50, 72, 94, 150, 600 ohms, all  $\pm 10\%$ .

**Output Pulse Amplitude:** 150-ma current source; voltage from each phase of push-pull channel, 0.15  $Z_0 \pm 20\%$ .

Typical nominal amplitudes, 50 ohms, 7.5v; 72 ohms, 10v; 94 ohms, 14v; 150 ohms, 22v; 600 ohms, 90v.

**D-C Component Insertion:** Binding posts provided for this purpose. DC can be moved  $\pm 25$  volts for all output impedances except 600 ohms.

**Accessories Supplied:** Interconnecting cables, TYPE CAP-35 Power Cord, 2 TYPE 874-C58 Cable Connectors, spare fuses.

**Other Accessories Available:** TYPE 1219-A Unit Pulse Amplifier (page 123) for higher power output.

**Accessories Required:** Trigger source; practically any laboratory oscillator of the appropriate frequency range is adequate; the TYPE 1210-B Unit R-C Oscillator (page 114) is recommended.

**Tube Complement: Generator:**

8 — 6485	1 — 5894
5 — 5965	2 — 6AN8
4 — 12AX7	2 — 12BY7
5 — 6AN5	2 — NE51
2 — 5963	1 — 5687
	1 — 6U8

Power Supply, 1 — 0C3, 1 — 6AK5, 1 — 6AS7.

**Power Supply Input:** 105 to 125 (or 210 to 250) volts, 50 to 60 cycles, 385 watts.

**Dimensions:** Generator, 19 (width) x 14 (height) x 12 $\frac{1}{2}$  inches (depth) over-all; Power supply, 19 (width) x 10 $\frac{1}{2}$  (height) x 12 $\frac{1}{2}$  inches (depth) over-all.

**Net Weight:** Generator, 30 pounds; power supply, 40 pounds.



### TYPE 1217-A UNIT PULSER

**USES:** The Unit Pulser is a compact, versatile and inexpensive source of pulse waveforms for the laboratory. The pulser is useful in transient studies on passive networks, square-wave testing of amplifier systems, and as a source of pulse-modulation voltage for R-F signal generators and oscillators.

An internal oscillator makes the unit independent of external synchronizing signals for most applications. The Unit Pulser can also be used as a simple time-delay generator over its range of available pulse durations. One pulser may be used to delay the trigger pulse for a second unit.

**DESCRIPTION:** Four basic circuits, a blocking oscillator, a monostable multivibrator, a limiter, and a cathode-follower, phase-splitter output stage, are employed in the Unit Pulser.

The blocking oscillator provides the internal repetition frequencies, and its voltage is used

to speed up the leading edge of the pulse. The multivibrator produces the adjustable-duration pulse. The limiter is used to remove imperfections in the pulse and to prevent amplitude variations with repetition rate and duration. The cathode-follower phase-splitter output system, provides either positive or negative output pulses.

**FEATURES:** ➤ Wide range of pulse durations and repetition rates.

- Fast rise time — 0.05  $\mu$ sec.
- Repetition rate can be set by external source, if desired.
- Pulse amplitude adequate for direct oscilloscope deflection.
- Pulse duration settings stable and accurate.
- Internal time delay of 1/10  $\mu$  sec permits leading edge of pulse to be visible on most oscilloscopes.

### SPECIFICATIONS

**Pulse Repetition Rates:** 30 c, 60 c, both synchronized to power line; 100 c to 100 kc in 1-2-5 steps,  $\pm 15\%$  or 20 c whichever is greater; 15 c to 100 kc continuous with external source.

**Pulse Duration:** Continuous coverage in four ranges 0.2 to 60,000  $\mu$  sec. Accuracy  $\pm 15\%$  or 0.2  $\mu$ sec, whichever is greater.

**Pulse Shape:** Rise time 0.05  $\mu$ sec, Fall time 0.15  $\mu$ sec with output terminals shunted by 15  $\mu$ mf and 1 M $\Omega$ . The overshoot may be set to be less than 5% of one-half the maximum amplitude, and the top of the pulse is flat to within 5% of maximum amplitude of all durations.

**Minimum External Drive Voltage:** 26 volts or less, rms, for continuous locking from 15 c to 85 kc; 40 v, up to 100 kc; a 10-volt pulse will lock continuously from 0 to 25 kc. TYPE 1210-B Unit R-C Oscillator is recommended.

**Output Impedance:** 200 ohms for positive pulses, 1500 ohms for negative pulses.

**Open Circuit Output Voltages:** 20 volts for pulses of either polarity; negative pulse of 50 volts when positive output terminal is grounded.

**Stability:** No time jitter is visible where a full period is displayed on an oscilloscope.

**Tube Complement:** 6AK5, 6AN5, 6AL5, 6485 and two 12AT7.

**Accessories Supplies:** One multipoint connector, 10:1 200  $\Omega$  attenuator.

**Power Supply:** 300 volts, 55ma; 6.3 volts, 2a. TYPE 1203-A Unit Power Supply is recommended.

**Dimensions:** (Width) 10 $\frac{5}{8}$  x (height) 5 $\frac{3}{4}$  x (depth) 6 $\frac{1}{4}$  inches over-all, not including power-line connector cord.

**Net Weight:** 5 $\frac{1}{4}$  pounds.

Type		Code Word	Price
1217-A	Unit Pulser*	AMASS	\$235.00
1217-AS1	Unit Pulser* (50 cycles)	AMASSPASHA	250.00
1203-A	Unit Power Supply	ALIVE	40.00

\* PATENT NOTICE. See Notes 2 and 8, page viii.



## TYPE 1219-A PULSE AMPLIFIER



Used with any pulse source, this amplifier produces pulses with many different characteristics of duration, duty ratio, and impedance level at higher power levels. The amplifier may be driven by either positive or negative input pulses and produces output

pulses of either polarity. The combination of Unit Pulser and Unit Pulse Amplifier constitutes a high power output pulse generator of very moderate cost and small size. The Pulse Amplifier is equally useful with TYPE 1391-A Pulse, Sweep, and Time-Delay Generator.

### SPECIFICATIONS

**Output Pulse:** Open circuit voltage is between 10 and 250 volts, and is the product of impedance and available current listed below:

(1) Impedance:

- a. Positive Pulse: 50, 75, 100, 150 ohms all  $\pm 10\%$ .
- b. Negative Pulse: 50, 75, 100, 150, 200, 250, 300 ohms, all  $\pm 10\%$ ; 570 ohms  $\pm 20\%$  designed to permit maximum output voltage.

(2) Output Current in milliamperes:

Duty Ratio	Positive Pulse %		Negative Pulse	
	DR Sw 0.2	DR Sw 0.5	DR Sw 0.2	DR Sw 0.5
0.05	620 $\pm 10\%$	350 $\pm 15\%$	575 $\pm 10\%$	330 $\pm 15\%$
0.2	560 $\pm 10\%$	300 $\pm 15\%$	475 $\pm 10\%$	275 $\pm 15\%$
0.5		250 $\pm 15\%$		225 $\pm 15\%$

(3) Rise and Decay Times: See table below.

(4) Pulse Shape: Less than 5% overshoot.

(5) Noise: Hum less than 1% of amplitude.

(6) Maximum duration to 10% droop: The droop is approximately linear with increasing pulse duration.

Input	Positive Output	Negative Output
Negative 30 v	2000 $\mu$ sec.	4000 $\mu$ sec.
Negative 55 b	10,000	4000
Positive 10 v	10,000	6000

(7) Maximum Repetition Rate: Limited only by duty ratio.

**Input Impedance:** Positive input, 50 kilohms shunted by 30  $\mu$ f; negative input, 5 kilohms and 30  $\mu$ f.

**Tube Complement:** One 6J6, one 12AU7, two 5763.

**Accessories Supplied:** One TYPE 874-C58 Cable Connector; spare fuses.

**Power Supply:** 105-125 volts, 50-60 cycles, 75 watts.

**Dimensions:** (Width) 10 $\frac{1}{2}$  x (height) 5 $\frac{3}{8}$  x (depth) 6 $\frac{1}{4}$  inches over-all. **Weight:** 8 $\frac{1}{2}$  lbs., net.

#### Output Characteristic

Input Pulse			Output Characteristic				Output Switch Setting
Polarity	Amplitude	Rise and Decay Time	Duty Ratio Sw 0.2		Duty Ratio Sw 0.5		
			Rise Time	Decay Time	Rise Time	Decay Time	
Negative	30 v	2 m $\mu$ sec. 50 m $\mu$ sec.	50 m $\mu$ sec.	30 m $\mu$ sec.	40 m $\mu$ sec.	20 m $\mu$ sec.	Negative, 50 $\Omega$
	30 v		50	50	60	50	Negative, 50 $\Omega$
Negative	50 v	1217-A Pulser	100	100	30	90	Negative, 570 $\Omega$
			80	80	60	70	Positive, 50 $\Omega$
			60	90	40	80	Negative, 50 $\Omega$
			100	120	90	110	Negative, 570 $\Omega$
Positive	2.5 v	1217-A Pulser	90	120	70	100	Positive, 50 $\Omega$
			180	160	120	130	Positive, 150 $\Omega$
			60	240	40	160	Negative, 50 $\Omega$
			110	240	80	160	Negative, 570 $\Omega$
(Minimum necessary drive)	25 v	1217-A Pulser	90	180	90	120	Positive, 50 $\Omega$
			180	240	130	160	Positive, 150 $\Omega$
			50	80	40	60	Negative, 50 $\Omega$
			90	110	100	100	Negative, 570 $\Omega$
(Pulse stretching 0.3 $\mu$ sec.)	25 v	1217-A Pulser	90	110	60	80	Positive, 50 $\Omega$
			180	150	110	100	Positive, 150 $\Omega$

Type	Code Word	Price
<b>1219-A</b>   Unit Pulse Amplifier.....	ACRID	<b>185.00</b>

PATENT NOTICE. See Note 4, page viii.



## TYPE 1390-A RANDOM-NOISE GENERATOR

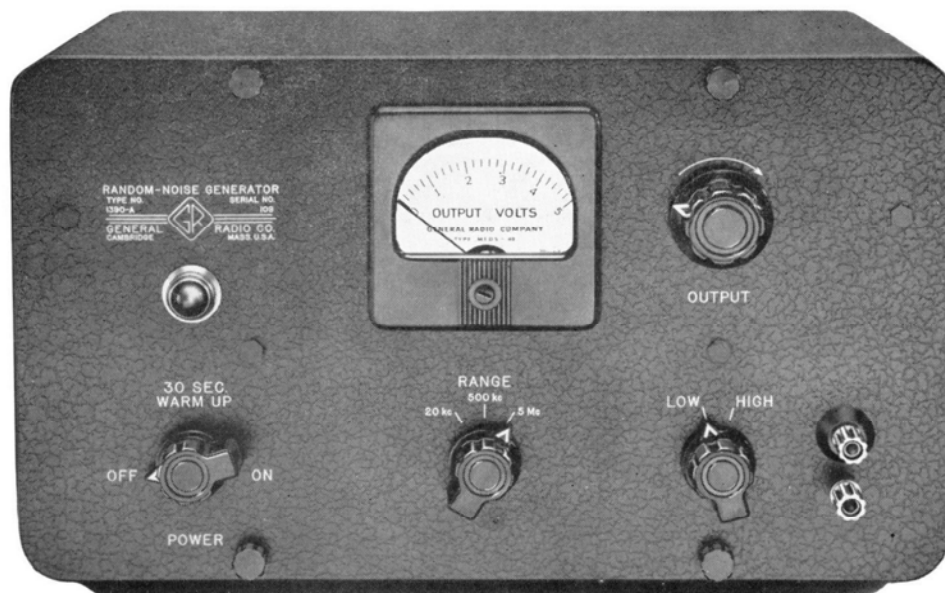

**USES:** This generator produces wide-band noise of uniform spectrum level for loud-speaker and microphone tests, filter tests, crosstalk measurements, noise-figure measurements, room acoustic measurements, psycho-acoustic tests, and modulating signal generators and test oscillators. A pair of these generators can be used as sources for illustrating various degrees of correlation, the fluctuations of random sampling, and other statistical illustrations.

**DESCRIPTION:** A gas-discharge tube is used as a noise source in this generator. A magnetic field is applied to the tube to eliminate the oscillations usually associated with a gas discharge. The noise output is amplified in a two-stage amplifier. Between the two stages of the amplifier, filters controlled by the range switch on the front panel of the instrument

shape the noise spectrum three different ways. The 20-kc setting puts in a low-pass filter that has a gradual roll-off above 30 kc, with the audio range to 20 kc uniform in spectrum level. The 500-kc setting puts in a low-pass filter that rolls off above 500 kc. The 5-Mc setting puts in a peaking network that compensates for the drop in noise output from the gas tube at high frequencies, so that a reasonably good spectrum is obtained to 5 Mc.

**FEATURES:** ➤ Wide range of frequencies covered  
 ➤ High over-all output level  
 ➤ Output meter provided  
 ➤ Uniform spectrum level over the audio range  
 ➤ Wide range of output levels available using the 1390-P1 Voltage Divider as an output control (see next page)

### SPECIFICATIONS

**Frequency Range:** (a) Range switch at 20 kc: uniform spectrum level from 30 c to 20 kc within  $\pm 1$  db.

(b) Range switch at 500 kc: Uniform spectrum level from 30 c to 500 kc within  $\pm 3$  db

(c) Range switch at 5 Mc: uniform spectrum level from 30 c to 500 kc within  $\pm 3$  db and from 500 kc to 5 Mc within  $\pm 8$  db.

**Output Voltage:** Maximum open-circuit output voltage on any one of three bands is 1 volt rms. Average spec-

trum level for one-cycle band with 1 volt output is: 20-kc band, 6 millivolts; 500-kc band, 1 millivolt, 5-Mc band, 0.5 millivolt.

**Output Impedance:** Source impedance for maximum output is 900 ohms. The output is taken from a 2000-ohm potentiometer. One output terminal is grounded.

**Waveform:** A very good normal, or Gaussian, distribution of amplitudes for limited ranges of the frequency spectrum is provided by the gas-tube noise source. The



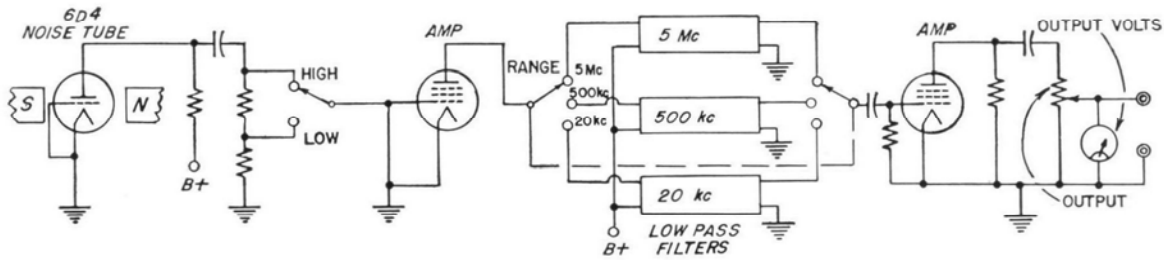

Elementary schematic circuit diagram of the TYPE 1390-A Random-Noise Generator.

amplitude limitations of a vacuum-tube amplifier modify this distribution slightly for the 20-kc range. Clipping occurs on the 500-kc and 5-Mc ranges.

**Voltmeter:** A rectifier-type, average meter is used for measuring the output voltage. It is calibrated to read the r-m-s value of the noise at the output terminals.

**Controls:** Frequency range switch, power switch, output potentiometer, and a 10:1 level attenuator.

**Terminals:** Jack-top binding posts with standard 3/4-inch spacing. The lower terminal is grounded to the panel.

**Accessories Supplied:** TYPE CAP-35 Power Cord and spare fuses.

**Accessories Recommended:** TYPE 1390-P1 Voltage Divider (see below).

**Mounting:** Metal cabinet.

**Power Supply:** 105 to 125 (or 210 to 250) volts, 50 to 60 cycles. Total power consumption is 50 watts.

**Tube Complement:** One 6D4, one 3-4 amperite, two 6AQ5's.

**Dimensions:** (Width) 12 x (height) 7 1/2 x (depth) 9 1/4 inches, over-all.

**Net Weight:** 15 pounds.

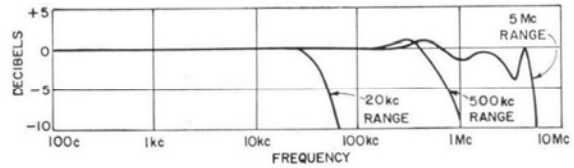

Typical Spectrum Level Characteristics for TYPE 1390-A Random-Noise Generator.

Type	Code Word	Price
1390-A   Random-Noise Generator.....	BUGLE	\$240.00

### TYPE 1390-P1 VOLTAGE DIVIDER

The TYPE 1390-P1 Voltage Divider extends the readable range of the output voltmeter-potentiometer combination of the TYPE 1390-A Random Noise Generator down to 20 microvolts. The voltage divider consists of a ladder-type resistive network, mounted in a metal container, which is connected to the generator output by means of a shielded plug and cable. Multiplying factors of 0.1, 0.01, 0.001 and 0.0001 can be selected.

Measurements on high-gain, wideband systems are possible because the frequency characteristic of the divider is flat within 10% for all settings at frequencies up to 5 megacycles.



#### SPECIFICATIONS

**Accuracy:** ± 3% at low-frequencies  
**Impedance:** input 2000 ohms, output 200 ohms.

**Dimensions:** (Height) 4 1/2 x (diameter) 4 1/2 inches.  
**Net Weight:** 1 1/2 pounds

Type	Code Word	Price
1390-P1   Voltage Divider.....	OTTER	\$55.00

# METERS

In the following section of the catalog are described general-purpose meters of several types and one specialized instrument, the TYPE 1501-A Light Meter. The general-purpose meters include vacuum-tube voltmeters for the measurement of alternating voltages over very wide ranges of frequency, and direct voltage of either polarity where negligible current can be taken from the source; oxide-rectifier meters for measuring input voltage and output power, principally in the audio range; and megohmmeters for the measurement of high resistances ranging to two million megohms.

The Light Meter integrates light intensity with respect to time, providing an exposure index for color photography with electronic speed lights.

A d-c amplifier and electrometer, described in the AMPLIFIER section, can be used as an electrometer voltmeter to measure millivolts, micro-microamperes, and megamohms.

Meters of all these types represent pioneer work of the General Radio Company. The first instrument combining a diode peak rectifier with a degeneratively stabilized d-c amplifier to indicate the rectified voltage was introduced in 1937. Advantages of this arrangement are wide frequency range, high inherent stability, a convenient circuit for obtaining a multi-range meter, and a calibration substantially independent of tube characteristics. Voltmeters of this type are now used in every conceivable type of application. This type of circuit is the basis of both the highly-precise, wide-frequency-range TYPE 1800-B Vacuum-Tube Voltmeter, and the economical TYPE 1803-B Vacuum-Tube Voltmeter for measurements over a somewhat narrower frequency range. The excellent characteristics of these meters and other GR

meters are compared on these two pages.

The first megohmmeter was introduced in 1936 and applied the degenerative vacuum-tube d-c meter to the conventional ohmmeter circuit. In this application the degenerative circuit not only gives stability and linearity, but permits a large voltage swing to take place in the grid circuit of the tube and greatly increases the effective input resistance resulting from grid current. The TYPE 1862-B Megohmmeter, using this circuit, measures insulation resistance with test potentials of either 500 volts or 50 volts applied to the sample.

General Radio Company also pioneered in the application of oxide-rectifier meters to communication problems. The first constant-resistance output-power meter of this kind was introduced in 1929 and was followed by the TYPE 583-A Output Power Meter which combines the oxide-rectifier meter with a resistive load and a tapped transformer, providing a sensitive audio-frequency power meter for load resistances varying over a range of 8000 to 1. A larger model, the TYPE 783-A, measures power up to 100 watts.

## VOLTMETER CHARACTERISTICS

An important group of meters comprises the a-c voltmeters intended for use up through the radio-frequency range. These are the TYPES 1800-B and 1803-B line-operated Vacuum-Tube Voltmeters. In addition there is the combination of the TYPE 874-VR Voltmeter Rectifier and the TYPE 874-VI Voltmeter Indicator described in the Coaxial Elements section of the catalog. It is useful to compare these instruments in regard to upper frequency limit, input impedance, sensitivity and voltage range, and the response to different types of waveforms.

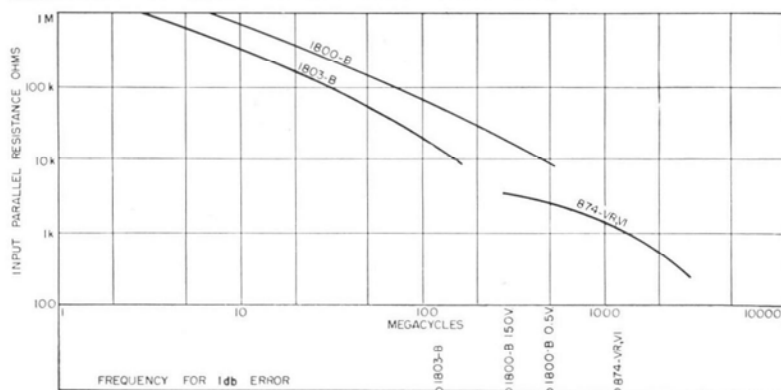

FIGURE 1. Curves of input parallel resistance of different General Radio voltmeters. The frequency at which the combined effects of transit time and resonance in the input circuit introduce a one-db error is given at the bottom of the figure.



Figure 1 gives the frequency at which the combined effects of transit time and resonance in the diode input circuit introduces an error of one db and shows curves for the corresponding reduction in the input resistance. At low voltages, transit-time effects tend to cancel the effect of approaching resonance, while at higher voltages only the resonance effect is significant. On its lowest (0.5 volt) range, the TYPE 1800-B reaches a frequency of 600 megacycles before the error becomes one db. All the meters are useful for comparison measurements well beyond the frequency limits given in the plot, or for voltage measurements if a calibration is made.

In the General Radio Standardizing Laboratory, each voltmeter is calibrated by means of a highly precise potentiometer against a standard cell certified by the National Bureau of Standards. Precise a-c calibration voltages are obtained by comparison with the d-c standard cell. Meters are individually aged and are checked for accuracy and drift over a sufficiently long period of time to assure that they will remain well within specified accuracy.

Figure 2 gives comparative data on voltage range and sensitivity. It will be seen that the TYPE 1800-B and the TYPE 1803-B measure from 0.1 to 150 volts directly. 10 : 1 ratio multipliers, TYPE 1800-P3 for low frequencies and TYPE 1800-P2 for high frequencies are available for the TYPE 1800-B Voltmeter, and a built-in multiplier is furnished on the TYPE 1803-B. These multipliers extend the range

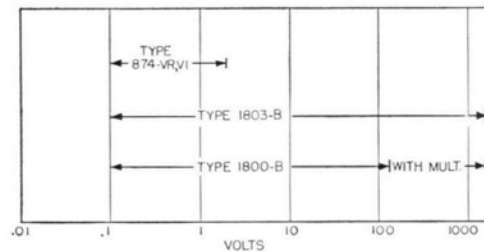

FIGURE 2. Voltage ranges of the different voltmeters.

of the instrument to 1500 volts. For d-c measurements, the TYPE 1803-B reads up to 500 volts directly. The TYPE 874-VR, VI combination described on page 49 is intended for voltage measurements in the v-h-f and u-h-f range. It covers 0.1 to 2 volts in a single range.

All the voltmeters which have been compared are essentially peak reading instruments, except that the vacuum-tube voltmeters on the more sensitive ranges approach a square-law characteristic. Although a peak-reading instrument is less useful than some other types for measuring the value of the fundamental component of a complex waveform in the presence of harmonics, the high stability of the peak instrument and its independence of the tube characteristics make it preferable for a large proportion of communication measurements. Except on very sharply peaked waveforms, the lowest range of the TYPE 1800-A Vacuum-Tube Voltmeter can be used with an external multiplier to read the r-m-s value of complex waveforms.

### CLASSIFICATION OF METERS

Type	Name	Quantity Measured	Range	Nominal Accuracy	Power Supply	See Page
1800-B	Vacuum-Tube Voltmeter	Volts, A-C or D-C	0.1-150*	±2%	A-C Line	128
1803-B	Vacuum-Tube Voltmeter	A-C Volts D-C Volts	0.1-1500† 0.2 to 500	±3% ±3%	A-C Line	130
874-VR 874-VI	Crystal Voltmeter	A-C Volts	0.1-2	±3%	A-C Line for Calibration	49
1862-B	Megohmmeter	Megohms	0.5-2,000,000	±3%	A-C Line	132
583-A	Output Power Meter	Power Impedance	0.1 mw-5 w 2.5-20,000 Ω	±0.5 db ±7%	None	133
783-A	Output Power Meter	Power Impedance	0.2 mw-100 w 2.5-20,000 Ω	±0.25 db ±2%	None	134
546-C	Microvolter	Voltage	0.5 μv-1 v	±3%	Audio Oscillator	135
1501-A	Light Meter	Light	50-12,800 lumen-seconds per square foot		Batteries	136
1230-A	Electrometer	Volts Current Resistance	0.5-10v 5 x 10 <sup>-15</sup> - 10 <sup>-3</sup> a 3 x 10 <sup>5</sup> - 5 x 10 <sup>11</sup> Ω	2%-4% 3%-10% 3%-8%	A-C Line	2

\* Multipliers are available to extend range to 1500 volts.  
† With built-in multiplier.



## TYPE 1800-B

### VACUUM-TUBE VOLTMETER



The General Radio TYPE 1800 Vacuum-Tube Voltmeter has gained widespread acceptance in the electronics industry as the most accurate peak-responding meter available.

It combines the accuracy of a laboratory instrument with the necessary durability for everyday laboratory and production line use. It measures alternating voltage at frequencies up to several hundred megacycles, as well as d-c voltages of either polarity.

Competent circuit design, the best available components, and a mechanical design that emphasizes convenience in use combine to produce the features listed below.

**DESCRIPTION:** The high-frequency probe contains an acorn-type diode rectifier connected by very short leads to the input capacitor, which is a small, button-type unit mounted on a low-loss insulating disc. Except for the small area of this insulation at the front, the probe is completely shielded. A metal cap screws onto the end of the probe and is used to attach various fittings and terminations to

the probe input. The cable, which also supplies heater power to the diode in the probe, carries the rectified voltage to a d-c amplifier and indicating meter in the cabinet of the instrument.

The d-c amplifier consists of a balanced twin triode operating in a highly degenerative circuit. The rectified alternating voltage is applied directly to the control grid of one triode, and a diode, which serves only to balance the effect of the initial-velocity current in the rectifying diode, is connected to the control grid of the second triode. The indicating meter is connected in series with precision resistors between the cathodes of the amplifying twin triodes. The change from one voltage range to another is made by changing the value of this series resistance.

**FEATURES:** ➤ High accuracy,  $\pm 2\%$   
 ➤ Wide frequency range; full range is covered without disassembly of probe and without addition of external capacitor.  
 ➤ Excellent low-frequency response.  
 ➤ Probe is shielded against strong r-f fields.

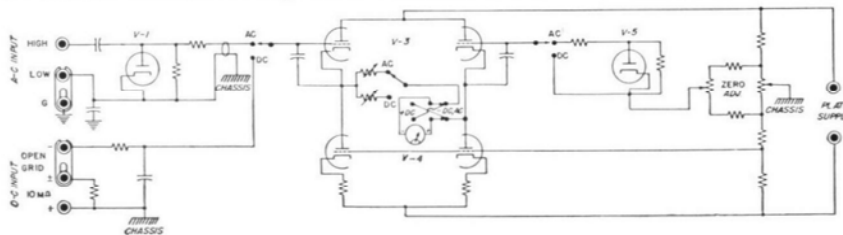

Elementary schematic circuit diagram for the TYPE 1800-B Vacuum-Tube Voltmeter.



- Probe cap can be bolted to ground plane to eliminate high-frequency errors resulting from inductance in ground connection.
- Single zero adjustment serves for all ranges; resetting from range to range is unnecessary.
- Coaxial fitting and 50-ohm coaxial resistor are supplied for use on probe.
- Calibration is stable and is substantially independent of tube characteristics.
- Regulated power supply eliminates fluctuation in meter indication and zero setting over wide range of line voltages.
- High input impedance.
- Illuminated mirror-type scale can be read under any ambient light conditions.
- Handle detents into position at right angles to panel to support panel at angle for easy reading.
- Polarity switch is provided for d-c measurements.

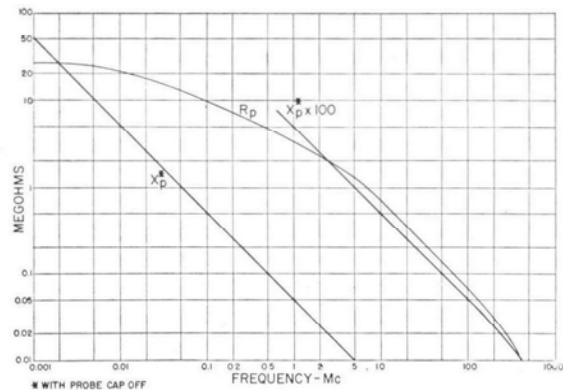

Plot of components of input impedance as a function of frequency.

- Wire-wound resistors are used in all positions that influence calibration stability.
- Only three controls to handle all functions.
- Fuses accessible from panel.

**SPECIFICATIONS**

**Voltage Range:** 0.1 to 150 volts, ac, in six ranges (0.5, 1.5, 5, 15, 50, and 150 volts, full scale); 0.01 to 150 volts, dc, in six ranges (0.5, 1.5, 5, 15, 50, and 150 volts, full scale).

**Multipliers:** Multipliers are available for increasing the range to 1500 volts. See page 131.

**Accuracy:** DC,  $\pm 2\%$  of full scale; AC,  $\pm 2\%$  of full scale for sinusoidal voltages, subject to frequency correction (see curve). Because of the change in resistance of the meter movement, the sensitivity of the lowest two ranges changes slightly with temperature and upon warming up of the instrument. The total warm-up decrease in sensitivity is about 1% of the indicated value on the 1.5-volt range and 3 to 4% of the indicated value on the 0.5-volt range. About one-half of this drift occurs in the first hour. The calibration is set to be correct after complete warm-up.

**Waveform Error:** On the higher a-c voltage ranges, the instrument operates as a peak voltmeter, calibrated to read r-m-s values of a sine wave, or 0.707 of the peak value of a complex wave. On distorted waveforms the percentage deviation of the reading from the r-m-s value may be as large as the percentage of harmonics present. On the lowest range the instrument approaches r-m-s operation.

**Frequency Error:** At high frequencies, resonance in the input circuit and transit-time effects in the diode rectifier introduce errors in the meter reading. The resonance effect causes the meter to read high and is independent

of the applied voltage. The transit-time error is a function of the applied voltage and causes the meter to read low. The accompanying curves show the frequency range for 1-db resultant error. It will be noted that at low voltages the transit-time and resonance effects tend to cancel, while at higher voltages the error is almost entirely due to resonance. The resonant frequency with cap on but plug removed is about 1050 Mc. Correction curves are supplied.

At the indicated frequency of 15 cycles, the meter indication begins to fluctuate as it tends to follow the voltage change within each cycle.

**Input Impedance:** At low frequencies the equivalent parallel resistance of the a-c input circuit is 25 megohms. At higher frequencies this resistance is reduced by losses in the shunt capacitance. The equivalent parallel capacitance at radio frequencies is 3.1  $\mu\text{f}$  with the probe cap and plug removed. At audio frequencies this capacitance increases slightly. The probe cap and plug add approximately 1.2  $\mu\text{f}$ . The plot above gives the variation of  $R_p$  with frequency.

On the d-c ranges two values of input resistance are provided, 10 megohms and open grid.

**Power Supply:** 105 to 125 or (210 to 250) volts, ac, 50 to 60 cycles. The instrument incorporates a voltage regulator to compensate for supply variations over this voltage range. The power input is less than 25 watts.

**Tube Complement:**

- 2—9005
- 1—6SU7-GTY
- 1—6C4
- 1—3-4
- 1—6SL7-GT
- 1—6AT6
- 1—6X5-GT
- 2—991

**Accessories Supplied:** TYPE CAP-35 Power Cord, spare fuses, TYPE 274 and TYPE 874 terminations, and 50-ohm coaxial terminating resistor for probe.

**Mounting:** Black-crackle-finish aluminum panel mounted in a shielded walnut cabinet. The cable and probe are stored in the cabinet. The carrying handle can be set as a convenient support for the instrument when placed on a bench with the panel tilted back.

**Dimensions:** (Width)  $7\frac{3}{8}$  x (depth)  $7\frac{1}{2}$  x (height)  $11\frac{1}{8}$  inches, over-all. **Net Weight:** 13 $\frac{3}{4}$  pounds.

Plot of frequency range for one-db error on the various voltage ranges; error is caused by transit time and resonance effects combined; data taken with complete probe, cap on, but banana plug removed.

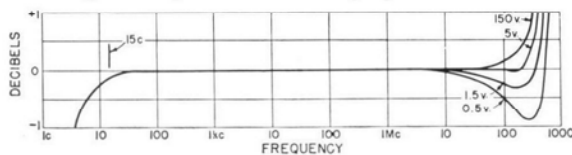

Type	Code Word	Price
1800-B   Vacuum-Tube Voltmeter.....	DUCAT	\$415.00

PATENT NOTICE. See Notes 2 and 4, page viii.



## TYPE 1803-B VACUUM-TUBE VOLTMETER

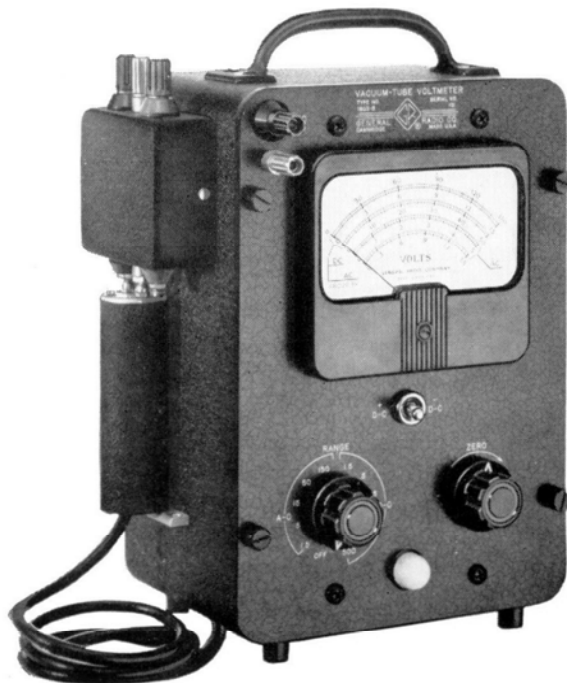

**USES:** This instrument is an accurate, high-quality, low-priced voltmeter designed to meet a majority of the requirements of voltage measurement in the laboratory, test shop, and the production line. Its 1500-volt a-c range covers power, audio, and low ultrasonic frequencies, while its 500-volt d-c range is adequate to measure the output of the majority of laboratory d-c power supplies. Its 150-volt a-c range extends to 150 megacycles with an error of only one db.

**DESCRIPTION:** For a-c measurements, the voltmeter is a peak-responding instrument cali-

brated to read rms value of a sine wave. It consists of a twin-diode rectifier mounted in a probe, followed by a d-c amplifier and indicating meter. For a-c measurements above 150 volts, up to 1500 volts, the probe is inserted in a multiplier unit on the side of the instrument, and the voltage is applied to the binding posts on top of the multiplier. The multiplier is a resistive voltage divider that has been compensated to have a response flat within  $\pm 2\%$  up to 40 kc and is so adjusted that the meter reads one-tenth the rms value of applied sine wave.

One diode in the probe is used to rectify the a-c voltage under measurement, and the other balances the effect of the initial-velocity current of the first. The d-c amplifier uses a twin-triode in a degenerative, balanced circuit. A-C power supply is built in, and the entire assembly is housed in a cabinet of heavy-gauge aluminum.

For d-c measurements the voltage is applied through a 111-megohm divider and a ripple filter to the d-c amplifier. The balanced amplifier circuit insures a good zero and calibration stability. A polarity switch is provided so that voltage of either polarity may be applied to the high input terminal.

- FEATURES:**
- Polarity switch for d-c.
  - Built-in multiplier.
  - Large, easily read meter.
  - Storage space for probe and cord available.
  - Completely shielded probe.
  - Zero adjustment for both a-c and d-c common to all ranges.
  - Balanced circuit minimizes variation of indication with line-voltage changes.
  - Simple construction results in versatile, quality instrument at low price.

### SPECIFICATIONS

**Voltage Ranges:** A-C: 0.1 to 150 volts, a-c, in five ranges (1.5, 5, 15, 50, and 150 volts, full scale). A multiplier is attached to increase the range to 1500 volts at audio and ultrasonic frequencies. D-C: 0.02 to 500 volts, in six ranges (1.5, 5, 15, 50, 150, and 500 volts, full scale).

**Accuracy:** AC,  $\pm 3\%$  of full scale, subject to frequency correction above 50 megacycles. Correction curve supplied in instruction book. Use of the multiplier imposes an additional error of  $\pm 1\%$ .

DC,  $\pm 3\%$  of full scale for the 1.5, 5, 15, 50-volt ranges;  $\pm 4\%$  of full scale for the 150 and 500-volt ranges.

**Waveform Error:** The instrument is calibrated to read the r-m-s value of a sine wave on all a-c ranges. On the higher ranges, the instrument is peak responding, and the reading corresponds to either the r-m-s value of a sine wave or 0.707 of the peak value of a complex wave. On distorted waveforms, the percentage deviation of the reading from the r-m-s value may be as large as the

percentage of harmonics present. On the lower ranges, the response departs from peak and approaches r-m-s response. When the multiplier is used, the voltmeter is not peak responding. The multiplier is adjusted so that the voltmeter reads one-tenth of the r-m-s value of a sine-wave voltage applied to the multiplier.

**Frequency Error:** The plot on this page shows the frequency for one-db error at two different voltage levels. At low voltages, the transit time and resonance effects tend to cancel, while at higher voltages, the error is almost entirely due to resonance. The resonant frequency is about 430 Mc.

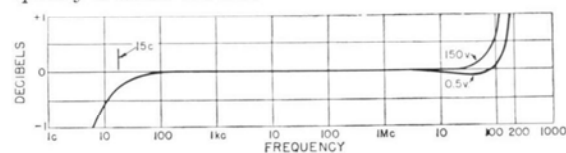



At low frequencies, the response drops off because of the increasing reactance of the series capacitance of the input circuit. At the indicated frequency of 15 cycles, the meter indication begins to fluctuate as it tends to follow the voltage change within each cycle.

The response of the multiplier is flat within  $\pm 2\%$  up to 40 kc.

**Input Impedance:** The equivalent a-c input circuit is a resistance in parallel with a capacitance. At low frequencies, the equivalent parallel resistance is 7.7 megohms. At high frequencies, this resistance is reduced by losses in the shunt capacitance. The equivalent parallel capacitance at radio frequencies is  $10 \mu\text{f}$ .

At audio frequencies, the capacitance increases to  $12 \mu\text{f}$ . The multiplier input impedance is a resistance of approximately 9 megohms in parallel with  $11 \mu\text{f}$ .

The d-c input resistance is 111 megohms. By removal of an internal connection, open-grid input can be obtained for the 1.5, 5, 15, and 50-volt ranges.

**Power Supply:** 105 to 125 (or 210 to 250) volts, 50 to 60 cycles. The power input is about 11 watts.

**Accessories Supplied:** Spare fuses.

**Tube Complement:** 1-6AL5 1-6SU7-GTY 1-6X4.

**Dimensions of Cabinet:** (Width)  $8\frac{1}{4}$  x (depth)  $6\frac{1}{2}$  x (height)  $11\frac{3}{4}$  inches over-all.

**Net Weight:**  $9\frac{1}{2}$  pounds.

Type	Code Word	Price
1803-B   Vacuum-Tube Voltmeter.....	ABOOM	\$195.00

## MULTIPLIERS FOR THE TYPE 1800 VACUUM-TUBE VOLTMETERS

### TYPE 1800-P2 HIGH-FREQUENCY MULTIPLIER

A capacitive voltage divider that provides a ten-to-one reduction of the applied voltage, this multiplier screws on to the end of the voltmeter probe to extend the a-c range from 150 to 1500 volts.

#### SPECIFICATIONS

**Multiplication Ratio:** 10:1  $\pm 5\%$ , as received. An adjustment is provided to permit the user to match the multiplier to the TYPE 1800-A or -B to better than  $\pm 1\%$  accuracy.

**Frequency Characteristics:** See plot. The multiplier is not recommended for use below 100 kc. At high frequencies, the multiplier does not affect over-all voltmeter response.

**Input Impedance:** Resistance 100 times that of the volt-

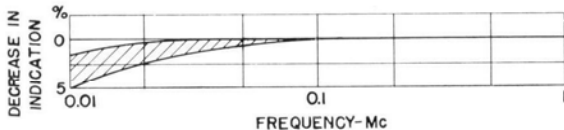

(Left)  
TYPE 1800-P2



(Right)  
TYPE 1800-P3

meter alone. Parallel capacitance is  $1.5 \mu\text{f}$  with the probe cap and plug removed,  $2.0 \mu\text{f}$  with them attached.

**Dimensions:**  $2\frac{5}{8}$  (length) x  $1\frac{5}{8}$  (diameter) inches over-all. Adds two inches to the probe length.

**Net Weight:** 4 ounces.

Type	Code Word	Price
1800-P2   Multiplier.....	ABODE	\$23.00

### TYPE 1800-P3 LOW-FREQUENCY MULTIPLIER

When plugged into the binding posts on the TYPE 1800-A or -B panel, it extends both the d-c and low-frequency a-c ranges to 1500 volts. The multiplier is a capacitance-resistance and fixed resistance divider for a-c and d-c respectively. It is not intended for use at frequencies above 100 kc. The TYPE 1800-P2 Multiplier should be used for frequencies above this value.

#### SPECIFICATIONS

**D-C Multiplication Ratio:** 10:1  $\pm 1.5\%$ .

**Sine-Wave A-C Multiplication Ratio:** 10:1  $\pm 5\%$ .

**Frequency Characteristics:** Adjustments are provided to permit the user to match the multiplier exactly to his TYPE 1800-A or -B at any single frequency from 20 cycles to 5 Mc. When multiplier is adjusted for zero error at 1 kc and at 15 kc, the frequency error will be less than  $\pm 3\%$  from 20 cycles to 20 kc, and less than  $\pm 5\%$  up to 100 kc.

**Waveform:** Errors in multiplication ratio may be as large as the percentage distortion of the signal.

**Input Impedance:** 10 megohms shunted by  $10 \mu\text{f}$ .

**Dimensions:** 5 x 2 x 2 inches, over-all.

**Net Weight:** 8 ounces.

Type	Code Word	Price
1800-P3   Multiplier.....	ABHOR	\$35.00



## TYPE 1862-B MEGOHMMETER



**USES:** Rugged, versatile, and safe, this megohmmeter rapidly measures wide ranges of resistance at either of two test voltages. The 50-volt level is useful in resistance measurements on printed circuits, transistor circuit components, and miniaturized circuit com-

ponents. The 500-volt level is a standard value for measuring the insulation of rotating electrical machinery, transformers, cables, capacitors, appliances, and other power-line-operated equipment.

The stabilized power supply and the low time constant introduced by the testing circuit permit rapid and accurate measurement of the leakage resistance of capacitors.

Guard and ground terminals permit measurement of the grounded and ungrounded sections of three-terminal resistors.

**DESCRIPTION:** The megohmmeter consists of a stabilized power supply, a complement of resistance standards, and an indicating meter. The indicator is a balanced, d-c vacuum-tube voltmeter that has two volts full-scale sensitivity and a very high input resistance.

**FEATURES:** ➤ Rugged, direct-reading and simple to operate.

➤ Two test voltages, 50 and 500 volts. Useful for approximate measurement of voltage coefficient.

➤ Voltage can be removed from unknown terminals by setting switch to CHECK or DISCHARGE positions, thus permitting connections to be made without danger of shock.

➤ Guard and ground terminals provided.

➤ Test leads furnished.

### SPECIFICATIONS

**Range:** 0.5 megohm to 2,000,000 megohms at 500 volts and to 200,000 megohms at 50 volts. There are six decade steps as selected by a multiplier switch.

**Scale:** Each resistance scale up to 500,000 megohms utilizes 90% of the meter scale. Center-scale values are 1, 10, 100, 1000, 10,000 and 100,000 megohms.

**Accuracy:** From  $\pm 3\%$  at the low-resistance end of each decade, to  $\pm 12\%$  at the high-resistance end up to 50,000 megohms. There can be an additional  $\pm 2\%$  error at the top decade. For 50 volt operation, there is an additional  $\pm 2\%$  error on all but the 0.5 to 5 megohms decade where the additional error can be  $\pm 5\%$ .

**Voltage On Unknown:** 50 or 500 volts, as selected by switch on front panel, indicator lamp is lighted when 500 volts are applied. At resistance values below 0.5 megohm, the applied voltage drops to limit the current to safe values. Voltage across unknown is 500 volts within  $\pm 10$  volts, or it is 50 volts within  $\pm 4$  volts. This voltage source is stabilized for operation from 105-125 volt lines (or 210-250 volt line).

**Terminals:** Unknown, ground and guard terminals. At two positions of a panel switch, all voltage is removed from all terminals to permit connection of the unknown in safety. In one of the positions, the UNKNOWN terminals are shunted to discharge the capacitive component of the unknown. All but the ground terminals are insulated.

**Calibration:** Switch position provided for standardizing calibration.

**Tube Complement:** One each, 12AU7, OA2, 6X4, 2X2-A, 6AB4, 6AU6, 5651.

**Mounting:** Black-crackle-finished aluminum panel and cabinet with carrying handles and black phenolic protective sides.

**Power Supply:** 115 (or 230) volts, 40-60 cycles, 25 watts. **Accessories Supplied:** spare fuses; two color-coded test leads.

**Dimensions:** 10  $\frac{1}{8}$  (height) x 9  $\frac{1}{8}$  (width) x 11  $\frac{3}{4}$  (depth) inches, over-all.

**Net Weight:** 15  $\frac{1}{2}$  pounds

Type	Code Word	Price
1862-B   Megohmmeter.....	JUROR	\$235.00

**MEGOHM BRIDGE:** The TYPE 544-B Megohm Bridge, a bridge-type instrument for resistance measurements in the megohm range, is described on Page 16.

**ELECTROMETER:** The TYPE 1230-A D-C Amplifier and Electrometer, described on page 2 measures resistances as high as  $10^{14}$  ohms, as well as very low voltages and currents.





**TYPE 583-A**  
**OUTPUT-POWER**  
**METER**



**USES:** The output-power meter reads directly the amount of audio-frequency power that a source is capable of delivering into any desired load. Thus the effect of load impedance on power delivered can be easily measured, and the characteristic impedance of telephone lines, phonograph pickups, oscillators, and similar equipment can be found by observing the impedance which gives the maximum reading on the instrument.

In the testing of radio receivers, the TYPE 583-A Output-Power Meter is very useful as an output indicator for standard selectivity, sensitivity, band-width, and fidelity tests; an auxiliary decibel scale is furnished on the meter for this purpose.

**DESCRIPTION:** This instrument may be considered to be an adjustable load impedance across which is connected a voltmeter that is calibrated directly in watts lost in the load. Actually the input is connected through a multitap transformer and a resistance network to an output meter.

- FEATURES:**
- The power range covered is 50,000 : 1 and the impedance range 8000 : 1.
  - All readings can be made directly and quickly.
  - Considerable overloads, for short periods of time, can be handled by the rectifier-type voltmeter used as the indicating element.

**SPECIFICATIONS**

**Power Range:** 0.1 to 5000 milliwatts in four ranges (5, 50, 500, 5000 milliwatts, full scale). The copper-oxide meter is calibrated from 1 to 50 milliwatts with an auxiliary scale reading from 0 to 17 decibels above a reference level of 1 milliwatt. With the multiplier the total range is -10 to +37 decibels above 1 milliwatt.

**Impedance Range:** 2.5 to 20,000 ohms. Forty discrete impedances, distributed approximately logarithmically, are obtained by means of a ten-step OHMS dial and a four-step MULTIPLIER.

**Accuracy:** The accuracy of both power and impedance measurements varies with frequency. The maximum error in full-scale power reading does not exceed 0.5 decibel between 150 and 2500 cycles, nor does it exceed

1.5 decibels at 20 and 10,000 cycles. The average error is 0.3 decibel at 30 and 5000 cycles, and 0.6 decibel at 20 and 10,000 cycles.

The maximum error in impedance does not exceed 7% between 150 and 3000 cycles, nor does it exceed 50% at 20 and 10,000 cycles. The average error is 8% at 30 and 5000 cycles and 20% at 20 and 10,000 cycles.

**Waveform Error:** The indicating instrument used is a copper-oxide rectifier-type meter, calibrated in r-m-s values for a sinusoidal applied voltage. When non-sinusoidal voltages are applied, an error in indication can occur, since the meter is not a true r-m-s indicating device. The error will depend on the magnitude and phase of the harmonics present, but with waveforms normally encountered in communications work, will not be serious.

**Mounting:** The instrument is mounted on an aluminum panel in a walnut cabinet.

**Dimensions:** (Length) 10 x (width) 7 x (height) 6 inches, over-all.

**Net Weight:** 8¼ pounds.

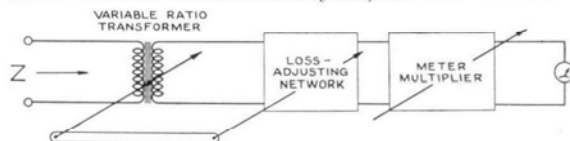

Type	Code Word	Price
583-A	ABUSE	\$155.00



## TYPE 783-A OUTPUT-POWER METER

**USES:** The TYPE 783-A Output-Power Meter is a direct-reading instrument for measuring the power output of audio-frequency circuits.

Some of its specific uses include the testing of amplifiers, transformers, and other networks. It is particularly useful for simulating loud-speaker or other load impedances in testing the output characteristics of high-power audio systems, since it will measure power outputs as high as 100 watts. It is sufficiently sensitive, on the other hand, to be useful for measurements on very low-level circuits.

**DESCRIPTION:** Functionally, the TYPE 783-A Output-Power Meter is equivalent to an adjustable load impedance across which is connected a voltmeter that is calibrated directly in watts dissipated in the load.

**FEATURES:** ➤ A power range extending to 100 watts is provided by this meter.  
 ➤ Frequency and impedance characteristics are improved over those of the smaller TYPE 583-A Output-Power Meter.  
 ➤ The auxiliary decibel scale is a convenience for many types of measurements.

### SPECIFICATIONS

**Power Range:** 0.2 milliwatt to 100 watts in five ranges (10 and 100 milliwatts, 1, 10 and 100 watts, full scale). An auxiliary decibel scale on the meter reads from -10 to +10 decibels above a reference level of 1 milliwatt. With the multiplier the total range is -10 to +50 decibels above 1 milliwatt.

**Impedance Range:** 2.5 to 20,000 ohms. Forty discrete impedances, distributed approximately logarithmically, are obtained by means of a ten-step OHMS dial and a four-step MULTIPLIER.

**Impedance Accuracy:** The input impedance is within  $\pm 2\%$  of the indicated value, except at the higher audio frequencies, where the error for the higher impedance settings may exceed this value. At 15,000 cycles the input impedance error is about 5% for impedances from 10,000 to 20,000 ohms.

**Power Accuracy:** The indicated power is accurate to  $\pm 0.25$  db at full-scale reading. At the lowest impedance multiplier setting (2.5 to 20 ohms) there may be an additional error of 0.2 db due to switch contact resistance when the power multiplier is set at 10 (10 to 100 watt range).

The over-all frequency characteristic of the power indication is flat within  $\pm 0.5$  db from 20 cycles to 10,000 cycles; within  $\pm 0.75$  db to 15,000 cycles.

**Waveform Error:** The indicating instrument used is a copper-oxide rectifier meter, calibrated in r-m-s values for a sinusoidal applied voltage. When non-sinusoidal voltages are applied, an error in indication can occur, since the meter is not a true r-m-s indicating device. The error will depend on the magnitude and phase of the harmonics present, but, with waveforms normally

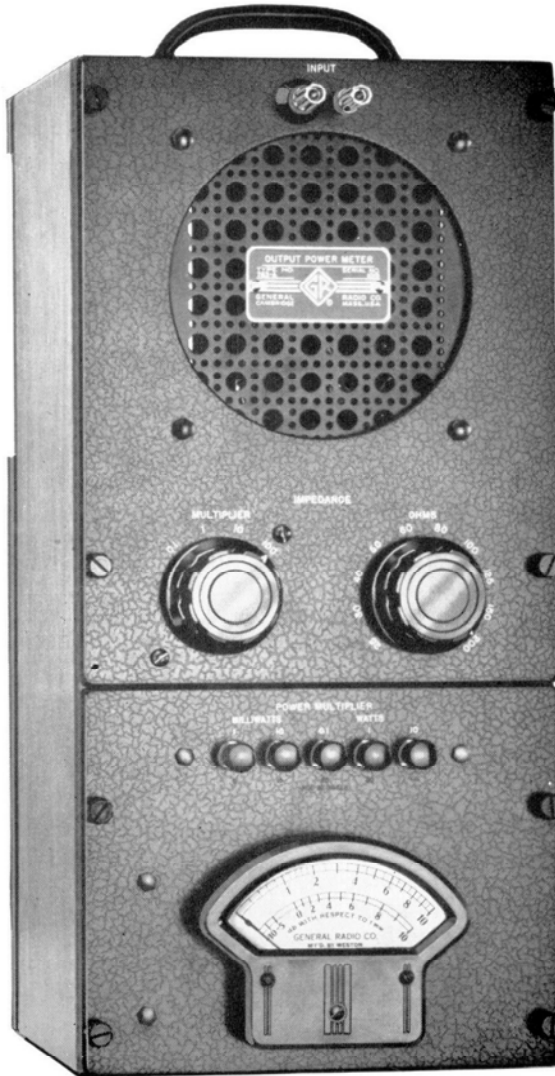

encountered in measurement circuits at communications frequencies, will not be serious.

**Temperature and Humidity Effects:** Humidity conditions have a negligible effect on the accuracy of the instrument.

The instrument is calibrated at 77° Fahrenheit and, if the ambient temperature departs widely from this value, additional errors of indication may be expected. At high temperatures (95° Fahrenheit) this additional error may approach the nominal calibration error, particularly at the higher frequencies.

The instrument is so designed that the heat dissipated by the instrument itself has a negligible effect on the accuracy.

**Mounting:** The instrument is mounted on an aluminum panel in a walnut cabinet.

**Dimensions:** 8 x 18 x 7 inches, over-all.

**Net Weight:** 17 pounds.

Type	Code Word	Price
783-A   Output-Power Meter . . . . .	ABBEY	\$360.00



## TYPE 546-C AUDIO-FREQUENCY MICROVOLTER

**USES:** The TYPE 546-C Audio-Frequency Microvolter used in conjunction with an oscillator is a useful source of small, known, audio-frequency voltages. In measuring the response of amplifiers, transformers, and other audio equipment, such a source of known input voltage is extremely valuable. The microvolter can also be used to measure other small voltages by substitution methods.

**DESCRIPTION:** This instrument consists, essentially, of a constant-impedance attenuator and a voltmeter by means of which the input to the attenuator is standardized. A switch controls the output voltage in decade steps, while an individually calibrated dial provides continuous control over each decade.

**FEATURES:** ➤ An excellent frequency characteristic, extending from very low frequencies up to 100,000 cycles, is available in this instrument.  
 ➤ Excellent accuracy is obtainable for absolute voltage levels as well as for voltage ratios,

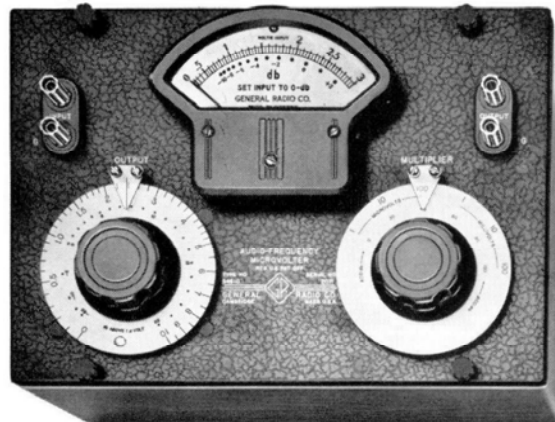

which are all that are needed in gain or loss measurements.

➤ Decibel scales, in addition to the voltage calibration of the meter and multipliers, are provided. These scales make it possible to obtain directly relative response characteristics in decibels.

### SPECIFICATIONS

**Output Voltage Range:** From 0.5 microvolt to 1.0 volt open circuit, when the input voltage is set to the standardized reference value.

**Accuracy:** For open-circuit output voltages the calibration is accurate within  $\pm(3\% + 0.5 \text{ microvolt})$  for output settings above 1 microvolt and for all frequencies between 20 and 20,000 cycles. For higher frequencies up to 100 kc the calibration is accurate within  $\pm 5\%$  for output settings above 100 microvolts. These specifications apply only where waveform and temperature errors are negligible (see below).

In calculating ratios of output voltages, at a given frequency, the accuracy of any given reading can be considered to be within  $\pm(2\% + 0.5 \text{ microvolt})$ , at frequencies up to 100,000 cycles. At frequencies above 20 kc this accuracy applies only at levels above 100 microvolts.

The microvolter can be used on dc by using an external d-c meter or by calibrating the internal meter for dc.

**Output Impedance:** The output impedance is approximately 600 ohms and is constant with setting within  $\pm 5\%$ . This impedance is sufficiently low so that no correction on the output voltage is necessary for load impedances of the order of 100,000 ohms and greater.

**Input Impedance:** Approximately 600 ohms, substantially independent of output setting on all but the highest multiplier position.

**Waveform Error:** The accuracy of the microvolter as a calibrated attenuator or voltage divider is independent of waveform. The absolute accuracy of the output voltage calibration depends on the characteristics of the input copper-oxide rectifier voltmeter, which has a small waveform error that depends in turn on both the phase and the magnitude of harmonics present in the input. This error in the voltmeter can, in general, be neglected when the microvolter is used with ordinary laboratory oscillators. The rectifier-type voltmeter itself introduces some distortion unless the source impedance is very low. With a 600-ohm source the distortion introduced is about 0.2%.

**Temperature Error:** The accuracy of the calibration is independent of temperature when the microvolter is used as an attenuator or voltage divider. The absolute accuracy is affected slightly by temperature because of change in the voltmeter characteristics. The necessary correction for temperatures from 65° to 95° Fahrenheit is furnished with the instrument. The effects of humidity are negligible.

**Power Source:** The driving oscillator must be capable of furnishing about 2.2 volts across 600 ohms, or about 8 milliwatts.

**Terminals:** Jack-top binding posts are mounted on standard  $\frac{3}{4}$ -inch spacing.

**Mounting:** The instrument is mounted on an aluminum panel in an aluminum cabinet.

**Dimensions:** (Length) 10 x (width)  $7\frac{1}{8}$  x (height)  $6\frac{1}{2}$  inches, over-all.

**Net Weight:**  $6\frac{1}{2}$  pounds.

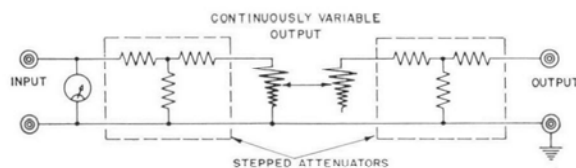

Type	Code Word	Price
546-C	CROWN	\$135.00
Audio-Frequency Microvolter* . . . . .		

\*Reg. U. S. Pat. Off.



## TYPE 1501-A LIGHT METER



**USES:** The General Radio Light Meter is a photographic exposure meter for use primarily with electronic flash lamps of the xenon type, commonly called "speedlights" or "strobe lights." It is particularly useful in the professional studio for exposure determinations with Kodachrome and other color films. This meter makes possible in high-speed flash photography the same accurate exposure standardization that the continuous-light exposure meter gives for ordinary photography.

The meter measures the light incident on the subject and indicates correct camera aperture for average subjects. In addition, an auxiliary probe is available, which attaches to the ground glass of the camera by means of suction cups, so that the light actually reaching the film can be measured, thus allowing for such indeterminate factors as lens absorption, bellows extension, etc. For this type of measurement, a white card is used as a standard subject. No calibration is supplied for measurements with the probe, but a few test

shots will give sufficient data for the user to determine his own calibration.

This light meter can be used to make routine checks on the condition of electronic flash lamps, to measure the output of a light source, and to determine the effectiveness of reflectors.

**DESCRIPTION:** The elements of the light meter are a light attenuator, a vacuum phototube, an integrating capacitor, and a vacuum-tube voltmeter. Light admitted by the attenuator strikes the photocell, causing current to flow through it. This current charges the capacitor, and the voltage across the capacitor is proportional to the integral of light with respect to time. This voltage is indicated by the vacuum-tube voltmeter, whose reading is a measure of the total light emitted by the flash tube.

The light attenuator consists of two Polaroid discs, one of which can be rotated 90° with respect to the other. The attenuator has two scales, one a proportional scale, the other a scale of *f* numbers.

The meter scale reads in lumen-seconds per square foot (foot-candle-seconds), and has a full-scale range of 200. The scale is direct reading when the light attenuator is set at 1 (*f*/3.5).

- FEATURES:**
- Portable and simple to operate.
  - Aperture can be read directly from attenuator scale.
  - Wide range of light intensities can be measured.
  - Both light incident on the subject and reflected light reaching the camera ground glass can be measured.

### SPECIFICATIONS

**Light Range:** A light range of 64:1 can be measured at mid-scale deflection, corresponding to 100 to 6400 lumen-seconds per square foot (foot-candle-seconds). The extreme readable range is about 50 to 12,800 lumen-seconds per square foot.

**Attenuator Range:** *f*/3.5 to *f*/22 corresponding to a range of 1 to 64 on the proportional scale.

**Tube Complement:** One 1P39 and one 1L4.

**Batteries:** One Burgess 2F, three Burgess XX30P1.

**Calibration:** Meter is standardized at the factory in terms of a calibrated xenon flashtube operated from a known capacitor at a specified voltage. A diffusion disc and aperture are individually fitted to each meter to standardize the reading.

**Spectral Characteristics:** The phototube has maximum

sensitivity in the blue-green portion of the visible spectrum.

**Response Speed:** For reliable results the flash should be 1/20,000 second (50 microseconds), or more, in duration.

**Accessories Supplied:** Tubes, batteries, diffusion disc, plug for flash-synchronizing circuit.

**Other Accessories Available:** A probe for light measurements at the camera ground glass is available at extra cost. See price list below.

**Mounting:** Walnut cabinet with hinged cover. Base of cabinet carries a tripod socket.

**Dimensions:** (Width) 7 x (height) 6½ x (length) 11 inches, over-all.

**Net Weight:** 8½ pounds.

Type		Code Word	Price
1501-A	Light Meter.....	COCOA	\$205.00
1501-P1	Probe.....	DANDY	26.50

PATENT NOTICE. See Note 6, page viii.

# RADIO STATION MONITORS

The General Radio Company pioneered in the development of measuring instruments for broadcasting stations, having supplied specialized frequency measuring equipment as early as 1924, and modulation measuring apparatus since 1931. Later, when the Federal Communications Commission required continuous monitoring, General Radio instruments were developed to satisfy these conditions.

The soundness of these early designs was attested by their wide acceptance and long, trouble-free operation. Each succeeding model profited by the field experience of its predecessor, and early obsolescence was never permitted to occur. Many of the extra features built into General Radio monitoring equipment assure long life in a rapidly changing industry. Approved monitoring equipment currently listed by the FCC still show General Radio equipment designed and placed in use more than 15 years ago, whose manufacture has been discontinued for more than a decade.

The General Radio Company alone has a continuous record of design and manufacture of this class of equipment, and this fact is widely recognized in the field of broadcasting. By a huge majority, radio and TV stations throughout the United States are GR equipped.

**Remote Monitoring:** Unattended transmitter operation usually requires that the monitoring equipment be adaptable to remote control operation. General Radio monitoring instruments have historically included such features as provision for external meter connections and as high an r-f input sensitivity as is consistent with reliable performance. The existence of these features in both old and new equipment assures adaptability to remote service.

**Frequency Monitors:** The function of the frequency monitor is to indicate the deviation of the transmitter frequency from its assigned channel. Fundamentally, it consists of a frequency standard and a means of indicating the difference between the transmitter frequency and that of the standard. For convenience in measuring the difference frequency, the frequency of the standard is usually offset from that of the assigned channel. The deviation indicator is calibrated directly in cycles (or kilocycles) off the assigned channel frequency.

**Modulation Monitor:** Percentage modulation for A-M

transmitters is measured by a system in which the modulated signal from the transmitter is rectified in a linear diode rectifier to produce an a-c voltage proportional to the instantaneous value of the carrier envelope and a d-c voltage proportional to the average carrier amplitude. The ratio of these voltages is continuously indicated by a voltmeter calibrated in modulation percentage. A flashing lamp indicates modulation peaks in excess of any pre-set level.

**Standard Broadcast Band:** For the standard broadcast frequencies, 540 to 1550 kilocycles, the TYPE 1181-A Frequency Deviation Monitor (page 138) and the TYPE 1931-A Modulation Monitor (page 142) are used. These instruments are fully described on the pages indicated.

**F-M Broadcast:** For these broadcast services, the TYPE 1170-B Frequency and Modulation Monitor is recommended. This instrument employs a pulse-counter discriminator that is inherently linear and provides an output that can be used for measuring the fidelity characteristics of the transmitter. This monitor is described on page 139.

For multiplexed operation, this monitor will indicate only the modulation of the transmitter by the simplex, or main program channel.

**Television:** The new TYPE 1184-A Television Transmitter Monitor has been designed for use with both monochrome and color transmitters. It provides continuous indications of aural modulation and the frequency of both aural and visual transmitters, or a direct monitoring of the intercarrier frequency. Outputs are available for operation of a monitoring speaker, and for the measurement of the aural (f-m) transmitter fidelity characteristics, distortion, noise level, residual a-m noise on the aural transmitter, and residual f-m noise on the visual transmitter.

**Mobile F-M Transmitters:** For this service, FCC regulations do not require station monitors, but the specifications on center frequency and frequency deviation make necessary their frequent measurement and adjustment. Equipment recommended for this purpose consists of the TYPE 1110-A Interpolating Frequency Standard and the TYPE 720-A Heterodyne Frequency Meter, which is described in the Frequency Measurements section of this catalog, on pages 85 and 86.

## OTHER BROADCASTING STATION MEASUREMENTS

**TV Transmitter Harmonics:** These measurements, now required by FCC Regulations, can be made with standard General Radio coaxial measuring equipment. See TYPE 874-FR Rejection Filters, page 58.

**Tube Burnouts Greatly Reduced by Automatic Line-Voltage Regulator:** Experience of broadcasters indicates that use of the TYPE 1570 Regulator on the transmitter filament supply quickly saves its cost by greatly reducing tube burnouts. See page 218 for description of this regulator.

**Distortion:** The FCC Standards of Good Engineering Practice specify maximum permissible percentage of distortion for various broadcast services. The TYPE 1932-A Distortion and Noise Meter (page 226) and the TYPE 1301-A Low Distortion Oscillator (page 103) are designed to measure transmitter distortion, as well as carrier noise, rapidly and accurately. The Distortion and Noise Meter operates from the output of the TYPE 1931-A Modulation Monitor, the TYPE 1184-A TV Transmitter Monitor, or the TYPE 1170-B F-M Monitor.

Type	Monitor	Page
1181-A	Frequency Deviation Monitor . . . . .	138
1181-AT	Color Sub-carrier Monitor . . . . .	139
1170-B	F-M Monitor . . . . .	139
1184-A	Television Transmitter Monitor . . . . .	140
1931-A	Modulation Monitor . . . . .	142

**Antennas, Lines, etc.:** The General Radio Company manufactures an extensive line of bridges and other impedance-measuring equipment suitable for determining the impedance of antennas, lines, and phasing and matching networks. For various frequency bands, the following instruments are recommended:

Type	Page
50 kc-5 Mc	916-AL R-F Bridge . . . . . 38
400 kc-60 Mc	1606-A R-F Bridge . . . . . 36
10-165 Mc	1601-A V-H-F Bridge . . . . . 39
50-1500 Mc	1602-BA Admittance Meter . . . . . 40
300-3000 Mc	874-LBA Slotted Line . . . . . 46



## TYPE 1181-A FREQUENCY DEVIATION MONITOR



FOR A-M  
TRANSMITTERS

FCC APPROVAL  
NO. 1467

**USES:** The Type 1181-A Frequency Deviation Monitor indicates directly the magnitude and direction of the frequency deviation of a broadcast transmitter from its assigned channel frequency. A monitor of this type is required for each station by the Federal Communications Commission.

The Frequency Deviation Monitor can be used to monitor A-M transmitters from a location remote from the transmitter site, as required in FCC rules permitting unattended operation of transmitters. The low input signal required, (approximately 10 millivolts), permits operation up to several miles from the transmitter with only a single-wire antenna necessary to pick up adequate signal voltage. The antenna may be tuned to provide additional selectivity, if desired. The narrow frequency band of the i-f system in the monitor usually provides adequate noise rejection.

**DESCRIPTION:** Voltages from a temperature-controlled piezo-electric oscillator (offset 1000 cycles from the assigned channel frequency) and the transmitter to be monitored are amplified and fed to a mixer from which their difference frequency is obtained. This audio frequency is amplified; its peaks are clipped to produce an essentially square waveform, which is applied to an audio-frequency meter. The

indicator is calibrated to read zero when the audio beat is exactly 1000 cycles. Deviations from 1000 cycles are indicated directly as the frequency deviation of the transmitter in cycles.

The monitor is a-c operated and is mounted on a single relay-rack panel.

**FEATURES:** ➤ Proved by use. Almost every broadcast transmitter in America is equipped with this monitor.

- Approval No. 1467 has been issued for this monitor.
- Simple to install — easy to maintain.
- High reliability for continuous service.
- Suitable for remote monitoring.
- Deviation indication is unaffected by amplitude modulation.
- Deviation indication is independent of r-f input level, over a wide range.
- Very low r-f input power.
- Positive indication of failure of transmitter carrier is provided by signal-level pilot lamps. A push-button test indicates whether or not the monitor crystal voltage is adequate. Other pilot lamps indicate heater-thermostat and power circuit operation.
- External deviation-indicating meter can be connected.

### SPECIFICATIONS

**Deviation Range:**  $\pm 30$  cycles, readable to one cycle.  
**Carrier Frequency Range:** 500 to 2000 kc.  
**Accuracy:** When received, within  $\pm 10$  parts per million. An adjustment is provided to bring the reading into

agreement with monitoring station measurements.  
**Stability:** Better than one part in a million under normal operating conditions. Adjustments are provided to correct the indicated frequency in terms of standard-



frequency transmissions whenever necessary.

**Tube Complement:**

- |             |               |
|-------------|---------------|
| 3 — 6SJ7    | 1 — 5V4-G     |
| 2 — 6AC7    | 1 — 6B4-G     |
| 2 — 6H6     | 1 — 0C3/VR105 |
| 2 — 6SQ7-GT | 1 — 2050      |
|             | 1 — 6V6       |

**Coupling to Transmitter:** A few inches of wire serving as an antenna is usually sufficient. A minimum of 10 millivolts is required into a high-impedance grid circuit.

**Accessories Supplied:** Quartz plate, ZCAP-5 Power Cord, spare fuses, and plug for connecting an external meter.

**Power Supply:** 105 to 125 (or 210 to 250 volts), 50 to 60 cycles.

**Power Input:** 25 watts for heater circuits, 100 watts for monitor circuits.

**Mounting:** 19-inch relay-rack panel.

**Panel Finish:** Standard General Radio black crackle. Certain standard finishes which can be processed in quantity can also be supplied.

**Dimensions:** Panel (length) 19 x (height) 15 3/4 inches. Depth behind panel, 13 inches.

**Net Weight:** 51 pounds.

Type	Code Word	Price
<b>1181-A</b>   Frequency Deviation Monitor.....	MALAY	<b>\$775.00</b>

PATENT NOTICE. See Notes 2, 5, 15, 16, page viii. When ordering please give channel frequency.

### TYPE 1181-AT COLOR SUBCARRIER MONITOR

A new model of the TYPE 1181 Frequency Deviation Monitor, designed specifically for monitoring the color subcarrier frequency of 3.579545 megacycles in color television transmitters operating under FCC Regulations. Although color-subcarrier monitoring is not yet

required by FCC regulation, it is implied in the required accuracy specification of 10 cycles. The accuracy and stability of this monitor,  $\pm$  one cycle for 30 days or  $\pm$  5 cycles for one year is more than adequate to insure compliance with the accuracy specification.

#### SPECIFICATIONS

Same as for TYPE 1181-A except as specified below:  
**Frequency:** 3.579545 megacycles.  
**Accuracy:**  $\pm$  one cycle per second for 30 days;  $\pm$  5

cycles for one year.

**Coupling to Transmitter:** Shielded cable and plug provided.

Type	Code Word	Price
<b>1181-AT</b>   Color Subcarrier Monitor.....	MAJOR	<b>\$775.00</b>

PATENT NOTICE. See Notes 2, 5, 15, 16, page viii.

### TYPE 1170-B F-M MONITOR

For monitoring the center frequency and modulation swing of transmitters used in F-M broadcasting, this monitor, described in previous catalogs is still available. In addition to these functions, it supplies a high-fidelity output for distortion and noise measurements and a 600-ohm output for aural monitoring.

When used on multiplexed transmission, it responds only to the normal F-M broadcast transmission.

This monitor has an accuracy of 200 cycles, or better, for a 30-day period and meets all FCC requirements for F-M broadcast service.

Type	Code Word	Price
<b>1170-B</b>   F-M Monitor...	AHEAD	<b>\$1835.00</b>

PATENT NOTICE. See Notes 1, 2, 5, and 16, page viii.

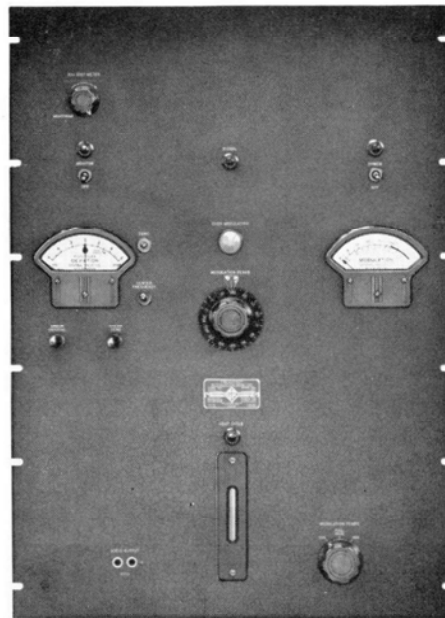



## TYPE 1184-A TELEVISION TRANSMITTER MONITOR

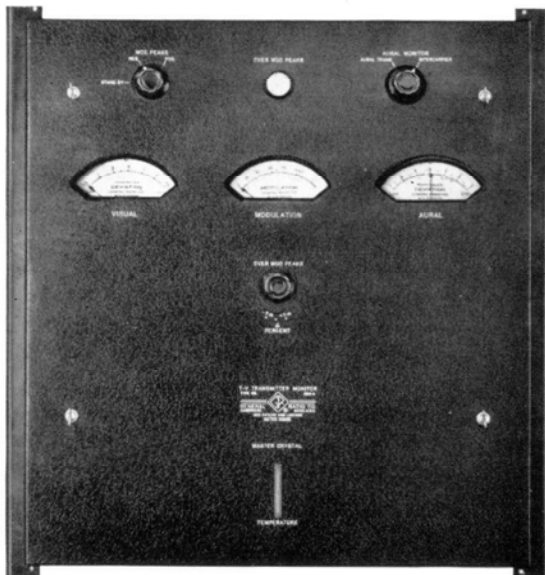

**USES:** The Television Transmitter Monitor provides, in one complete unit, all the functions necessary to meet the requirements of the Federal Communications Commission for monitoring television transmitters, plus other functions that make it possible for the station operating staff to check either continuously or periodically several key factors that indicate the operating condition of the transmitter. This instrument will:

Indicate continuously the frequency deviations from FCC-assigned values of both the aural and the visual transmitters.

Indicate continuously the difference, or intercarrier, frequency.

Indicate continuously the frequency-modulation (swing) of the aural transmitter.

Indicate by flashing a light, when the swing exceeds a preset value.

Provide continuous audible monitoring of intercarrier FM that will instantly warn against loss of either carrier or of overmodulation of the visual carrier.

In addition, the following measurements can be made:

Audio fidelity (distortion, noise, and frequency response) measurements on the aural transmitter, as required by FCC proof-of-performance regulations.

Residual a-m noise on the aural transmitter.

Residual f-m noise on the visual transmitter with full video-modulation applied. (This can be monitored continuously on an external Distortion and Noise Meter, such as the TYPE 1932-A)

A complete intercarrier demodulation system is provided in which the sound recovery is identical with that of an intercarrier-type receiver.

All metering circuits can be connected to external indicators. An audio output is provided for connection to 600-ohm monitoring lines.

This monitor will operate on any U-H-F or V-H-F television channel, with both color and black-and-white transmitters.

**DESCRIPTION:** The monitor chassis is mounted on slides and pivots that always support the weight. It can be installed, operated, and serviced entirely from the front. It is completely accessible while in operation, without removal from the relay rack. All controls, including circuit-function test switches, are available directly behind an easily removable panel plate which can be supplied in color to match other station equipment as desired.

Chassis marking is so complete that most maintenance operations can be done without using an instruction book. Key voltages can be checked by a panel meter and a switch, and chassis pin jacks provide for rapid checking at other points.

The monitor operation is shown in the block diagram. A highly stable, precision crystal oscillator is used as a master reference frequency, whose appropriate harmonic is used to produce beats of 150 kc and 4.35 Mc, respectively, with the aural- and visual-transmitter carrier frequencies.

The 4.35 Mc beat frequency operates (1) a frequency meter calibrated in terms of the visual-carrier frequency deviation and (2) a limiter-discriminator circuit whose output is a measure of the f-m noise on the visual transmitter carrier.

The 150-kc beat frequency operates (1) the modulation meter calibrated in percentage frequency-modulation of the aural transmitter, (2) the audio monitoring and fidelity measuring systems, and (3) a frequency meter calibrated in deviation from the assigned transmitter frequency.

The three functions noted above can be switched to operate from a separate intercarrier-beat detector, whose output is heterodyned with a secondary-reference oscillator. The performance obtained simulates the sound recovery in an intercarrier-type receiver, and the frequency meter directly indicates deviation of the intercarrier beat frequency from its FCC assigned value of 4.5 Mc  $\pm$  1 Kc.





SPECIFICATIONS

**Frequency Range:** 50-890 Mc (tv channels 2 to 83).

**RF Input:**

1. Impedance: Low-impedance loop coupling.
2. Level: Intended for use with standard RETMA transmitter monitoring outputs (10 volts, 50Ω).
3. Max Sensitivity: One volt, for all functions except the measurement of residual AM noise on the aural transmitter, which requires a minimum of 4 volts r-f input.
4. Adjustments: Input levels for both aural and visual transmitter are adjustable from the front of the instrument.
5. Indication: Both aural and visual transmitter input levels can be checked by direct indication on a front panel meter.

**Frequency: Crystal Stability** — master reference, ±1.4 ppm/30 days or ±0.35 ppm/10 days; secondary reference, ±5 ppm/30 days (=21.5 cycles); interpolating reference oscillator, ±5 ppm/30 days (=22.5 cycles).

**Accuracy:**

	Aural	Visual	Inter-Carrier
Meter Scale	3-0-3 kc	1.5-0-1.5 kc	3-0-3 kc
Metering Accuracy	±200c	±30c	±200c
Overall Accuracy	VHF 500c/30 days UHF 50c/10 days		250c for 30 days

**Image Frequency Check:** A checking device is incorporated to insure that the transmitter frequency is on the correct side of zero beat.

**Aural Modulation (FM): Meter Scale,** 0 to 100% + 3 db, full scale; **Meter Ballistics,** as required by FCC specifications; **Meter Calibration,** 100% = 25 kc deviation; selector switch for 100% = 50 kc to permit wide-deviation type tests; **Polarity Response,** panel switch for positive or negative peaks, for both meter and flashing lamp; **Peak Indicator,** flashing lamp indicates peaks in excess of dial setting; **Dial,** calibrated from 0 to 100% and to +3 db above 100%; **Meter Frequency Response,** ±0.25 db from 50 to 15,000 cycles, ±0.5 db from 30 to 20,000 cycles; **Peak Indicator Frequency Response,** 0.5 db from 100 to 15,000 cycles.

**Fidelity Measurements:**

**Aural F-M Transmitter: Audio Outputs** (at low frequencies with 100% modulation), 10.8 volts into 100 kΩ or 0 db into 600 Ω. **Residual Distortion** (50 to 15,000 cycles), 0.15% for 25 kc modulation deviation, and 0.25% for 50 kc deviation; **Residual FM Noise,** -70 db below 25 kc modulation deviation; **Audio Response,** follows 75-μsec de-emphasis curve within ±0.5 db from 50 to 15,000 cycles, ±3 db from 15 to 30 kc; **A-M Noise Reference Level** (at low frequencies), 4 volts into 100 kΩ; **Residual Noise, AM,** -70 db below carrier level.

**Visual A-M Transmitter: Noise (FM) Measuring Output** (at low frequencies and 25 kc deviation), 1.5 volts into 100 kΩ load, 75-μsec de-emphasis circuit included; **Residual (FM) Noise,** -65 db below 25 kc deviation with normal video modulation on transmitter (-70 db without video modulation).

**Inter-carrier Measurements:** Same as for aural transmitter, except **Residual (FM) Noise** is -63 db below 25 kc deviation of aural transmitter with video modulation applied to visual transmitters.

**External Connections:**

1. Frequency Meters: Visual Transmitter, GR TYPE MEDS-41-3, 0-200 μa dc, 510 Ω, one side grounded. Aural Transmitter, GR TYPE MEDS-72, 0-100 μa dc, 510 Ω, one side grounded.
2. (FM) Modulation Meter: GR TYPE MEDS-28, 0-600 μa dc, 680 Ω, neither side grounded.
3. Modulation-Peak Indicator: 3 watt-115 v lamp, one side grounded.
4. Audio Monitoring Output: Unbalanced — 600 Ω, 100% modulation = 0 dbm.
5. Audio Measurement Output: Intended for use with the TYPE 1932-A Distortion and Noise Meter (100 kΩ unbalanced input); 10.8 volts output at low frequencies; behind-the-panel test jack for connecting on a temporary basis; rear jack provided for permanent wiring to rack-mounted Distortion and Noise Meter.
6. Power Cables: standby line, for master crystal oven; power line, for monitor circuits.

**Power Supply:**

1. Standby Operation: 15 watts, with master crystal oven operating. 115/230 volts; 50-60 cycles.
2. Normal Operation: Max demand 265 watts, with all thermostats on. Min demand 240 watts, with all thermostats off. 115/230 volts; 50-60 cycles. (155 watts during 30 second initial warm up).

**Mounting:** 19-inch rack-panel mounting. Front panel removable for access to controls. All controls available from front. Instrument mounted on slides for access to all parts. Designed for vertical-air-flow cabinet racks.

**Panel Finish:** GR black crackle; also available in certain other colors to match station equipment.

**Dimensions:** (Width) 19 x (height) 21 x (depth) 16 inches, over-all.

**Net Weight:** 75 lbs.

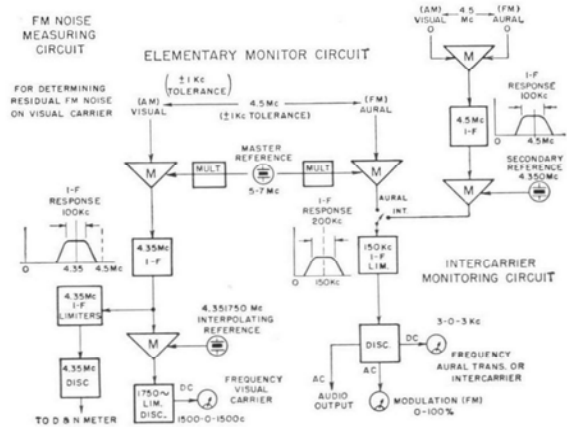

Type	Code Word	Price
1184-A Television Transmitter Monitor.....	GIANT	\$2650.00

PATENT NOTICE. See Notes 1, 2, 4, 5, and 16, page viii.

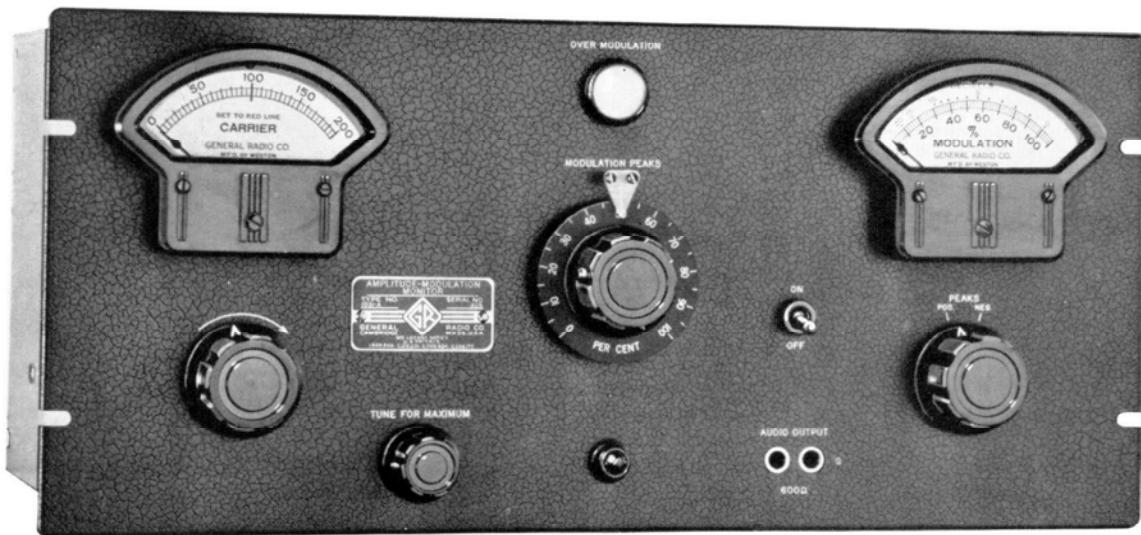

## TYPE 1931-A AMPLITUDE-MODULATION MONITOR

FCC APPROVAL No. 1555

**USES:** The modulation monitor is used to measure and to indicate continuously the percentage modulation of broadcast and other radio-telephone transmitters. The TYPE 1931-A Modulation Monitor performs the following specific functions:

1. Measurement of percentage of modulation on either positive or negative peaks.
2. Overmodulation indication.
3. Program-level monitoring.
4. Measurement of carrier shift when modulation is applied.
5. Measurement of transmitter audio-frequency response.

**DESCRIPTION:** TYPE 1931-A Modulation Monitor consists of three essential elements: (1) a linear diode rectifier which gives an instantaneous output voltage proportional to the carrier envelope, (2) a semi-peak voltmeter which gives a continuous indication of the peak modulation, and (3) a trigger circuit which flashes a light whenever the negative modulation peaks momentarily exceed any previously set value.

The linear rectifier is designed for operation at a low power level, which greatly simplifies the coupling to the transmitter. A d-c meter in the output of the linear rectifier indicates the carrier level at which the instrument is operating and also shows any carrier shift during modulation.

In addition, two auxiliary audio output circuits operating from a separate diode rectifier are provided. One of these, at 600 ohms, is intended for audible monitoring; the other, a high-impedance circuit, gives a faithful reproduction of the carrier envelope with less than 0.1% distortion and can be used for distortion and noise-level measurements.

**FEATURES:** ➤ Speed and simplicity of operation, essential for monitoring instruments, are available in this instrument. It operates over a wide carrier-frequency range, and a tuned input circuit is provided to facilitate coupling to the transmitter.

- The r-f power input required in the broadcast range is less than 0.5 watt.
- The flashing lamp is extremely useful as a monitoring device. It is set to flash with moderate frequency when the transmitter is operating normally. If the flashing rate changes markedly, the operator is made aware that the average level of modulation has changed.
- The flashing circuits are so designed that the indication is unaffected by moderate changes in carrier amplitude.
- Terminals are provided so that remote percentage modulation indicators can be connected to the instrument externally.
- FCC Approval No. 1555 has been issued for this monitor.



SPECIFICATIONS

**Range:** Modulation percentage, 0 to 110%, indicated by meter on positive peaks, 0 to 100% on negative peaks. The flashing lamp is adjustable to operate from 0 to 100% on negative peaks.

**Carrier-Frequency Range:** The monitor will operate at any carrier frequency from 0.5 to 60 megacycles. A single set of coils (either 0.5 to 8 megacycles or 3 to 60 megacycles) is supplied with each instrument, unless both sets are specifically ordered.

**Carrier-Frequency Input Impedance:** About 75 ohms in the broadcast band, increasing slightly at higher carrier frequencies and varying somewhat with input tuning.

**Accuracy:** The over-all accuracy of measurement at 400 cycles is  $\pm 2\%$  of full scale at 0% and 100%, and  $\pm 4\%$  of full scale at any other modulation percentage.

**Detector Linearity:** The distortion in the diode detector is very low for frequencies up to 7500 cycles. Above this frequency, a small amount of negative-peak clipping occurs, reaching 5% at the extreme high end of the audio range at 15,000 cycles and 100% modulation.

**R-F Power:** In the broadcast range the maximum r-f power requirement is about 0.5 watt.

**Tube Complement:** The following tubes are used:  
 2 — 6SN7-GT 1 — 2050  
 2 — 6SJ7 2 — 0D3  
 1 — 6AL5 1 — 6X5GT

**Warning Lamp Circuit:** The OVERMODULATION lamp will flash whenever the negative modulation peaks exceed the setting of the MODULATION PEAKS dial by 2% or more modulation, for audio frequencies between 30 and 7500 cycles. For higher audio frequencies, the percentage overmodulation required to flash the lamp increases slightly.

The accuracy of the dial calibration is  $\pm 2\%$  of full scale.

**Meter Circuit:** The response of the PERCENTAGE MODULATION meter circuit is flat, within  $\pm 0.25$  db,

between 50 and 15,000 cycles, and within  $\pm 0.1$  db between 100 and 10,000 cycles.

Either positive or negative modulation peaks may be read. Calibration in db below 100% modulation is provided.

The meter dynamic characteristic meets FCC specifications for modulation monitors.

**Audio Monitoring Output:** The audio output amplifier is flat, within  $\pm 1.0$  db, from 30 to 45,000 cycles. The internal impedance is 600 ohms. Distortion is less than 0.2%. Open-circuit output voltage is about 300 millivolts.

**Fidelity-Measuring Output:** Flat within  $\pm 1.0$  db between 30-30,000 cycles with TYPE 1932-A Distortion and Noise Meter connected. Distortion less than 0.1%.

Output level varies inversely with setting of MODULATION PEAKS dial, thus providing reasonably uniform input to distortion meter at all modulation levels. Average output level, approximately 1.5 volts.

Residual noise and hum level will not exceed -80 db.

**Auxiliary Output:** A multipoint connector at the rear of the instrument provides a means of connecting:

1. A remote Percentage Modulation Meter.
2. To a 600-ohm output for audio monitoring.
3. The TYPE 1932-A Distortion and Noise Meter.

**Power Supply:** 105 to 125 (or 210 to 250) volts, 50 to 60 cycles. Power input is approximately 50 watts.

**Accessories Supplied:** Multipoint connector TYPE ZCAP-5 Power Cord, spare fuses, and one set of input tuning coils (specify frequency range desired).

**Mounting:** The instrument is relay-rack mounted. End frames are available for table mounting. (See price list below.)

**Panel Finishes:** Standard General Radio black crackle. Certain standard grays which can be processed in quantity can also be supplied.

**Dimensions:** Panel (length) 19 x (height) 8 $\frac{3}{4}$  inches. Depth behind panel, 10 inches.

**Net Weight:** 32 $\frac{3}{4}$  pounds.

Type	Code Word	Price
1931-A Modulation Monitor, 0.5 to 8 Mc.....	TARRY	\$475.00
1931-A Modulation Monitor, 3 to 60 Mc.....	TOPIC	475.00
1931-P5 Extra Tuning Coils, 0.5 to 8 Mc.....	TABBY	23.00
1931-P6 Extra Tuning Coils, 3 to 60 Mc.....	TOTEM	23.00
FRI-510 End Frames.....	ENDFRAMEAT	13.00 pair

PATENT NOTICE. See Notes 1, 15, page viii.

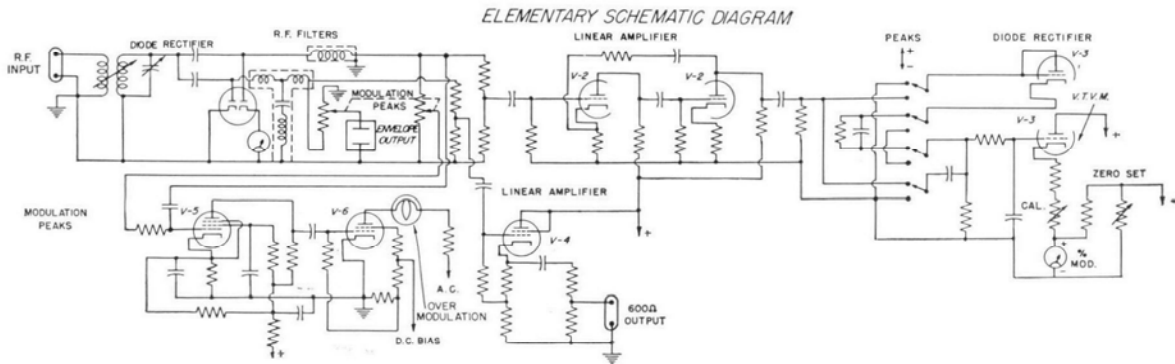

# POWER SUPPLIES

While most General Radio instruments have their own self-contained a-c power supplies, some have been designed with detachable power supplies for versatility and economy. These power supplies are also useful for general laboratory purposes, because they combine small physical size with high quality and high performance.

Most of the General Radio Unit Instruments use separate power supplies. These instruments can all be operated with the general-purpose TYPE 1203-A Unit Power Supply. For the ultimate performance in critical applications, the TYPE 1201-A Unit Regulated Power Supply provides constant voltage, greatly reduced ripple, and higher current ratings. For 6-volt or 12-volt storage-battery operation of Unit Instruments, the TYPE 1202-A Unit Vibrator Power Supply is available.

Another unit, the TYPE 1204-A Unit Variable Power Supply, is most useful in the laboratory to provide a d-c voltage adjustable from 0 to 300 volts at 100 ma.

Any of these Unit Power Supplies can be used with any Unit Instrument. Assemblies plug together for convenience, and can be solidly bolted together if desired. Rack mounting panels, TYPE 480-P, can be used to fasten a Unit Instrument and its power supply into a standard 19" rack.

The TYPE 1263-A Amplitude-Regulating Power Supply regulates the plate-supply voltage of an r-f oscillator to maintain a preset oscillator-output voltage. The resultant constant output voltage makes possible faithful reproduction in automatic display and plotting of amplitude response data.

For a-c operation of certain General Radio battery operated instruments, the TYPE 1261-A Power Supply is available. This supply is interchangeable with a TYPE BA48 (or 6TA60) Battery. Another model, the TYPE 1262-A Power Supply is used for a-c operation of the TYPE 1551-A Sound-Level Meter.

Type	Operated From	Output	Remarks	See Page
1203-A	115v, 60 c	6.3v, ac; 300v, dc		144
1201-A	115v, 60 c	6.3v, ac; 300v, dc	Regulated 300v	145
1202-A	6v or 12v storage battery or 115v, 60 c	6.3v, ac; 300v, dc; 115v, ac	a-c output is at 115 c	146
1204-B	115v, 60 c	6.3v, ac; 0 to 300v, dc	Includes Variac	145
1261-A	115v, 60 c	1.5 or 3v, dc; 133v, dc, open circuit	Replaces BA48 Battery	147
1262-A	115v, 60 c	1.2 and 1.5v, dc; 69v, dc, open circuit	Attaches to GR Sound Level Meter	147
1263-A	115v, 60 c	6v, dc; 0 to 250v, dc	For Amplitude control on Unit Oscillators	148

## TYPE 1203-A UNIT POWER SUPPLY

Although it may be used for other equipment, this power supply is designed primarily to supply a-c heater and d-c plate power for General Radio Unit Instruments. Connections are made to other Unit Instruments through a multipoint connector. A mating plug is furnished to facilitate connection to any other circuits.

### SPECIFICATIONS

**Output Voltages:** 6.3 volts a-c, 3 amperes maximum; 300 volts d-c, 50 milliamperes maximum. No load voltage, 410 volts.

**Hum Level:** About 250 millivolts at 300 volts and 50 milliamperes d-c output.

**Input:** 115 volts, 50 to 60 cycles, 50 watts full load.

**Rectifier:** 6X4.

**Output Terminals:** Standard multipoint connector mounted on the side of the unit.

**Accessories Supplied:** Spare fuses, a mating multipoint connector for connecting the power supply to other

equipment, a 10-32 screw with nut for permanently attaching the power supply to other Unit Instruments.

**Mounting:** Black-crackle finish aluminum panel and sides. Aluminum cover finished in clear lacquer.

**Dimensions:** 5 (width) x 5 3/4 (height) x 6 1/4 (depth) inches, over-all, not including power cord.

**Net Weight:** 5 1/4 pounds.

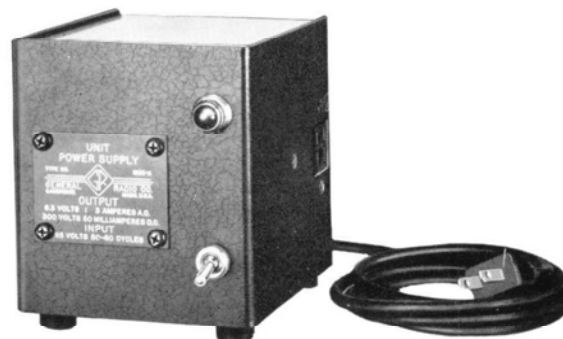

Type	Code Word	Price
1203-A Unit Power Supply (115 volts, 50-60 cycles).	ALIVE	\$40.00
1203-AQ11 Unit Power Supply (230 volts, 50 cycles) . . .	ALIVEREGAL	50.00



## TYPE 1201-A UNIT REGULATED POWER SUPPLY

The TYPE 1201-A Unit Regulated Power Supply is recommended for use with Unit Instruments where line voltage fluctuates badly or where maximum isolation is required from line voltage effects on oscillator output amplitude and frequency, amplifier hum level, or pulse-generator jitter.

The regulated unit is completely interchangeable mechanically and electrically with the TYPE 1203-A Unit Power Supply. It will, however, provide higher output currents with greatly reduced ripple and noise.

### SPECIFICATIONS

**High-Voltage Output:** 300 volts d-c  $\pm 1\%$ ; regulated within  $\pm 0.5\%$ ; 70 ma with a 120 cycle ripple less than 2 millivolts at full load.

**Heater Output:** 6.3 volts a-c; 4 amp. max; unregulated.

**Input:** 105-125 volts, 50 to 60 cycles, 100 watts.

**Tube Complement:** One each, 12AX7, 6AV5GT, 5651.

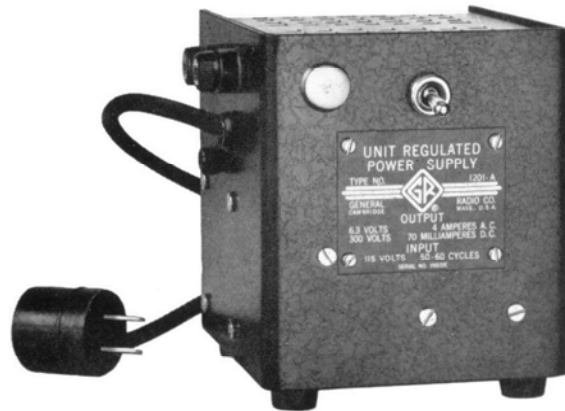

**Accessories Supplied:** Same as for TYPE 1203-A.

**Dimensions:** 5 (width) x  $5\frac{3}{4}$  (height) x  $6\frac{1}{4}$  (depth) inches, over-all.

**Net Weight:** 6 pounds.

Type		Code Word	Price
1201-A	Unit Regulated Power Supply (115 volts, 50-60 cycles).....	ASSET	\$ 80.00
1201-AQ18	Unit Regulated Power Supply (230 volts, 50-60 cycles).....	ASSETREGAL	100.00



An adjustable d-c plate voltage supply and a fixed a-c heater supply, both isolated from ground and from each other, are provided in the TYPE 1204-B Unit Variable Power Supply. They are available at insulated panel binding posts, and also at a multipoint connector mounted on the right-hand end, into which other Unit Instruments plug directly.

The d-c plate supply, is obtained from a pair of selenium rectifiers in a voltage-doubler circuit and is adjustable down to zero by a VARIAC® control. Both the d-c output voltage and the d-c load current are measured by a single switch-controlled panel meter.

## TYPE 1204-B UNIT VARIABLE POWER SUPPLY

### SPECIFICATIONS

**Output Voltage:** 6.3 volts a-c, nominal; 3 amperes maximum. The d-c output voltage is adjustable from zero to 300 volts with a maximum load of 100 milliamperes. Maximum no-load voltage, 400 volts.

**Hum Level:** About 250 millivolts at 300 volts, 100 milliamperes d-c load; about 150 millivolts at 350 volts, 50 milliamperes d-c load.

**Input:** 115 volts at 60 cycles; 75 watts at full output load. A line connector cord is permanently attached to the instrument.

**Accessories Supplied:** Same as for TYPE 1203-A.

**Mounting:** Black-crackle-finish aluminum panel and sides. Aluminum cover finished in clear lacquer.

**Dimensions:**  $9\frac{7}{8}$  (width) x  $5\frac{3}{4}$  (height) x  $6\frac{1}{4}$  (depth) inches, over-all, not including power line connector cord.

**Net Weight:**  $9\frac{3}{4}$  pounds.

Type		Code Word	Price
1204-B	Unit Variable Power Supply.....	AGATE	\$95.00



## TYPE 1202-A UNIT VIBRATOR POWER SUPPLY FOR FIELD USE WITH STORAGE-BATTERY POWER

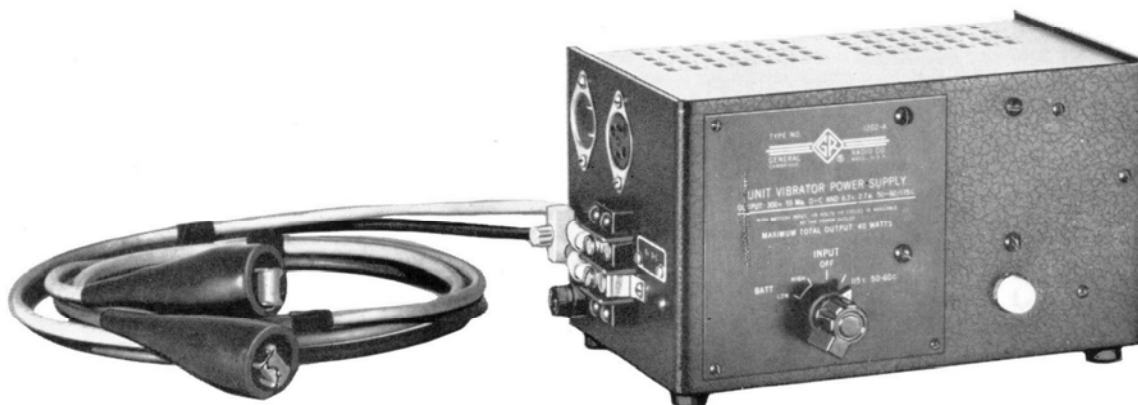

**USES:** The Unit Vibrator Power Supply will supply the power requirements of any Unit Instrument from either a 6-volt or a 12-volt storage battery. For those Unit Instruments designed for use with separate plug-in power unit, it supplies plate and heater power directly; for those with internal power supply (Types 1216 and 1219) it furnishes 115 volts, ac. As an added convenience, the Unit Vibrator Power Supply can also be operated from a 115-volt, 50- to 60-cycle, a-c line, thus avoiding unnecessary duplication of facilities where instruments must be used both in the laboratory and in the field.

**DESCRIPTION:** The TYPE 1202-A Vibrator Supply incorporates filtering for "hash" and r-f to an adequate degree. The frequency at the 115-volt outlet and at the heater supply outlet for battery-input operation is 115 cycles

and the wave-shape is approximately square. With power-line input, the heater-supply frequency is 50-60 cycles, sine wave. There are two switch positions for battery operation to allow for diverse battery and load conditions.

Selenium rectifiers are used in the plate-supply system for greater overall efficiency and less drain on the battery. The 6-foot battery cable has heavy-duty insulation to withstand the severe mechanical treatment that can be expected out of doors and at the battery of a car. It is fitted with extra-large battery clips. The leads are color-coded because the supply must be connected with due regard to the ground connection at the battery.

The complete supply is housed in a standard General Radio Unit Instrument cabinet that is about one fifth of a cubic foot in volume.

### SPECIFICATIONS

**Input:** Six-volt or twelve-volt storage battery or 115-volt, 50- to 60-cycle power line. Instrument is shipped with connections for 6-volt operation unless 12-volt supply is specified on the order.

**Output:** 300 volts at 55 ma d-c; 6.3 volts at 2.7 amperes a-c. With battery input, 115 volts at 115 cycles is also available. The maximum output is 40 watts.

**Vibrator:** A 6-volt vibrator is supplied with the instrument. It is used for both 6-volt and 12-volt operation.

**Output Connectors:** A standard multi-point connector is mounted on one side of the cabinet for plugging in Unit

Instruments. A standard a-c outlet on the other side of the cabinet for connection to instruments that normally plug into a power line.

**Accessories Supplied:** Spare fuses, a mating multipoint connector, a power line cord and a heavy cable for battery connection.

**Mounting:** Black-crackle-finish aluminum panel and sides. Aluminum cover finished in clear lacquer.

**Dimensions:** (Width) 10 1/8 x (height) 5 3/4 x (depth) 6 3/8 inches overall.

**Net Weight:** 11 1/2 pounds.

<i>Type</i>	<i>Code Word</i>	<i>Price</i>
1202-A	Unit Vibrator Power Supply..... AURAL	\$125.00

### RELAY-RACK ADAPTOR PANELS FOR UNIT POWER SUPPLIES

<i>Type</i>	<i>Fits</i>	<i>Code Word</i>	<i>Price</i>
480-P4U1	1203-A or 1201-A.....	UNIPANARCH	\$9.00
480-P4U2	1202-A or 1204-A.....	UNIPANBOLT	9.00



## TYPE 1261-A POWER SUPPLY

**USES:** The TYPE 1261-A Power Supply is an a-c power pack for use in place of batteries in battery-operated instruments. The power pack is interchangeable electrically and mechanically with a BA48 (Burgess Type 6TA60) battery. It can be used in the following General Radio instruments:

TYPE 720-A Heterodyne Frequency Meter  
 TYPE 1231-B Amplifier and Null Detector  
 TYPE 1550-A Octave-Band Noise Analyzer

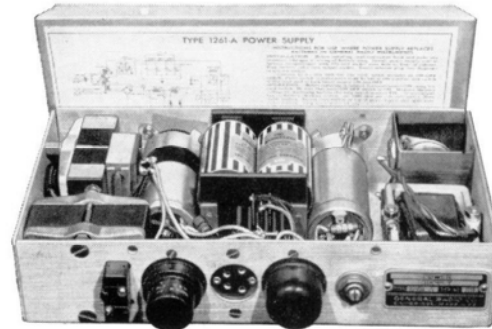

### SPECIFICATIONS

**OUTPUT:**

**Filament Supply:** 1.5 volts or 3.0 volts; maximum current 350 ma. Normal current needed through filter choke to operate relay is 300 ma.

**Plate Supply:** With 115-volt, 60-cycle input and 300 ma filament-current output, the plate supply voltage is:

133 volts open circuit	89 volts at 5 ma
107 volts at 3 ma	72 volts at 7 ma
8 ma maximum output current	

**Hum and Noise Level:** Sufficiently low to assure satisfactory operation of instruments listed under conditions specified.

**Input Voltage:** 105-125 (or 210-250) volts, 40 to 60 cycles.

**Input Power:** Approximately 10 watts.

**Tube Complement:** One 6H6.

**Batteries:** Two Burgess UNI-Cell No. 2 or Eveready No. 950.

**Terminals:** A four-terminal socket fits the battery-cable plug on the TYPE 720-A, TYPE 1550-A and TYPE 1231-B.

**Accessories Supplied:** One CAP-35A Power Cord.

**Dimensions:** (Length) 10 x (width) 2 1/4 x (depth) 5 inches.

**Net Weight:** 7 3/4 pounds.

Type		Code Word	Price
1261-A	Power Supply.....	NUTTY	\$128.00

## TYPE 1262-A POWER SUPPLY



### SPECIFICATIONS

**Filament Supply:** No. 1 1.2 volts at 45 ma  
 1.5 volts open circuit  
 No. 2 1.2 volts at 40 ma  
 1.5 volts open circuit

**Plate Supply:** 60 volts at 2 ma; 68 volts open circuit. (Nominal voltages obtained with 115-volt, 60-cycle input.)

**Hum and Noise Level:** Sufficiently low to assure satisfactory operation of the TYPE 1551-A Sound-Level Meter. With 115-volt, 60-cycle input, nominal values are:

Filament Supply:	No. 1	50 μvolts
	No. 2	50 μvolts
Plate Supply:		100 μvolts

**Input Voltage:** 105-125 volts, 50-60 cycles.

**Input Power:** Approximately 2 watts.

**Output Terminals:** A small four-terminal molded plug on a short, flexible cable fits socket on the TYPE 1551-A Sound-Level Meter panel.

**Input Connection:** Line cord is attached to power supply.

**Mounting:** Fastens to end frame of Sound-Level Meter with screws through power supply to inserts in the frame.

**Dimensions:** (Height) 6 1/4 x (width) 7 1/2 x (depth) 2 1/2 inches over-all.

**Net Weight:** 2 pounds 10 ounces.

Type		Code Word	Price
1262-A	Power Supply (115 volts, 50-60 cycles).....	MANLY	\$70.00
1262-AQ18	Power Supply (230 volts, 50-60 cycles).....	MANLYREGAL	85.00



## TYPE 1263-A AMPLITUDE-REGULATING POWER SUPPLY

### AUTOMATIC AMPLITUDE CONTROL FOR UNIT OSCILLATORS



In measurements by sweep methods, it is essential that the amplitude of the applied signal remain constant as a function of frequency. The Amplitude-Regulating Power Supply is designed to maintain constant output from General Radio Unit Oscillators and can be used with other oscillators if their power requirements are within the allowable range, and if a d-c connection can be made to the oscillator cathode circuit for supplying plate-current control.

The power supply compares the d-c potential developed by the oscillator output rectifier with an adjustable d-c reference potential, and applies a rapid correction to the oscillator plate supply to minimize the difference. It also supplies d-c power for the plate and the cathode heater of the oscillator.

Owing to its very-high-speed response, the amplitude-regulating Power Supply is particularly useful when used with a Unit Oscillator and the TYPE 1750-A Sweep Drive (page 200) for oscilloscope display of amplitude-frequency characteristics.

#### SPECIFICATIONS

**General:** For use with an oscillator whose output can be controlled by varying plate voltage applied. D-C connection to oscillator cathode must be available. Can be used with TYPES 1211-B, 1215-B, 1209-B, and 1218-A (pages 113 and 117).

**Plate Supply:** 0-250 volts at 25 ma with a 105 volt line. With a line voltage of 115-volts (or 230), up to 300 volts at 30 ma is available.

**Heater Supply:** 6 volts d-c at 0.5 amperes at 115-volt line. (5.4 volts at 0.7a)

**R-F Output Regulation:** Can be set from 0.2 to 2 volts. Oscillators that can deliver a minimum of 2 volts into 50 ohms within stated plate-supply limitation will be regulated within  $\pm 2$  percent of the preset level. Output change with rated line-voltage variation, less than 20 millivolts.

**Response Time:** Plate current is changed at a rate of 30 milliamperes per millisecond.

**Output Meter:** Internal d-c vacuum-tube voltmeter, calibrated in terms of the r-f voltage at the external output rectifier. Internal calibration means is provided for standardization of this meter with rectifier.

**Power Input:** 55 watts maximum at 115/230 volts.

**Power Supply:** 105 to 125 (or 210 to 250) volts, (50-60 cycles).

**Blanking:** Phone-tip jacks provided. Connection to a contactor in the TYPE 1750-A Sweep Drive cuts off oscillator plate supply to eliminate vertical deflection during the return sweep, and to provide base line.

**Tube Complement:** Three 12AX7, one each, 6V6-GT, 0A2, 6X4.

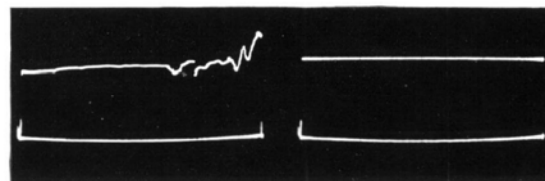

Oscillograms of output amplitude vs. frequency for the TYPE 1209-B Unit Oscillator (250 to 920 Mc) unregulated (left), and operated from the Amplitude-Regulating Power Supply (right). Oscillator was driven by the TYPE 1750-A Sweep Drive.

**Accessories Supplied:** CAP-35 Power Cord, cable for Unit Oscillator connection, multipoint connector plug, spare fuses.

**Other Accessories Required:** TYPE 874-VR Voltmeter Rectifier, TYPE 274-NF Patch Cord and TYPE 874-Q6 Adaptor for connecting output rectifier.

**Other Accessories Available:** TYPE 874-VQ Voltmeter Detector (page 49) and TYPE 874-WM 50-ohm Termination (page 55) for use as a matched detector when frequency response measurements are made on 50-ohm circuits; TYPE 874-VI Voltmeter Indicator (or a d-c microammeter) to indicate output of circuit under test for manual operation; TYPE 1750-A Sweep Drive (page 200) for automatic operation.

**Dimensions:** 13¼ (height) x 8¼ (width) x 7½ (depth) inches.

**Net Weight:** 18½ pounds.

Type		Code Word	Price
1263-A	Amplitude-Regulating Power Supply.....	SALON	\$280.00
874-VR	Voltmeter Rectifier.....	COAXRECTOR	30.00
274-NF	Patch Cord.....	STANPARGAG	1.50
874-Q6	Adaptor.....	COAXCLOSER	2.25



# STANDARD CAPACITORS

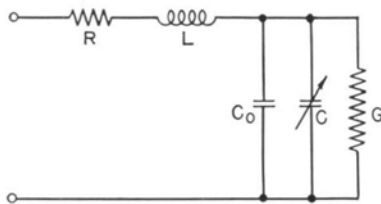

FIGURE 1. The equivalent circuit of a variable air capacitor.

## 1. AIR-DIELECTRIC CAPACITORS

The characteristics of a properly designed air capacitor approach very closely those of an ideal circuit element. Whether the capacitor is fixed or variable, a low temperature coefficient of capacitance, low losses, and a high degree of stability can be achieved.

For many measurements, and over a wide range of frequency, such a capacitor can be considered as having a terminal impedance defined solely by its electrostatic capacitance. However, for the most accurate measurements at audio frequencies or for measurements at radio frequencies, the small deviations from ideal performance must be examined and evaluated.

Figure 1 is a lumped constant equivalent circuit showing the residual parameters which cause the deviations from ideal performance.  $R$  represents the metallic resistance in the leads, stack supports and plates.  $L$  represents the series inductance of the structure and  $C$  the low frequency air dielectric capacitance. The capacitance  $C_0$  represents the capacitance of the dielectric supporting structure. The conductance  $G$  represents (a) the dielectric losses in the supports, (b) the losses in the air dielectric and on the surface of the plates (significant only at very high humidities), and (c) the d-c leakage conductance.

At low frequencies the capacitance at the terminals is  $C + C_0$  and only the component  $G$  need be considered in evaluating the dissipation factor. The effect of the leakage conductance is negligible at frequencies above a few cycles, and is ordinarily of importance only when the capacitor is used at dc, i.e., for charge storage. The losses in the air dielectric are negligible under conditions of moderate humidity and temperature.

At audio frequencies then, the dominant component of conductance is that contributed by dielectric losses in the insulating structure. Good quality, low-loss materials such as quartz, ceramics, and polystyrene used for

supports in air capacitors are characterized by a dissipation factor that is nearly constant with frequency. This corresponds to a conductance component that varies approximately linearly with frequency.

The dissipation factor of the equivalent circuit, at low frequencies, can be written as

$$D = \frac{G}{\omega(C + C_0)} = \frac{D_0 C_0}{C + C_0}$$

$D$  is thus inversely proportional to the terminal total capacitance, for a variable capacitor. The quantity  $D_0 C_0 = \frac{G}{\omega}$  is very nearly

independent both of frequency and setting and as such is a convenient figure of merit for the capacitor. Since  $D_0$  is dimensionless,  $D_0 C_0$  can be expressed in  $\mu\mu\text{f}$ .

As frequency is progressively increased, the impedances of  $R$  and  $L$  become significant compared to the reactance of  $C$  and must be taken into account.

The resistance  $R$  ordinarily is not significant except at frequencies where skin effect is essentially complete, under which condition its value varies as the square root of frequency and may be expressed as  $R_0 \sqrt{f}$ , where  $R_0$  is the resistance at one megacycle and  $f$  is the frequency in megacycles. The total dissipation factor of the capacitor when the resistance  $R$  is taken into account is

$$D = \frac{G}{\omega C} + R_0 \sqrt{f} \omega C \quad (2)$$

$L$  represents the inductance of the current path between terminals. It is largely concentrated in the leads and supporting members, and, as a consequence, is nearly independent of setting in a variable capacitor. The variation in effective terminal capacitance caused by  $L$

FIGURE 2. Variation of effective capacitance and  $D$  with frequency for TYPE 722 Precision Capacitors.

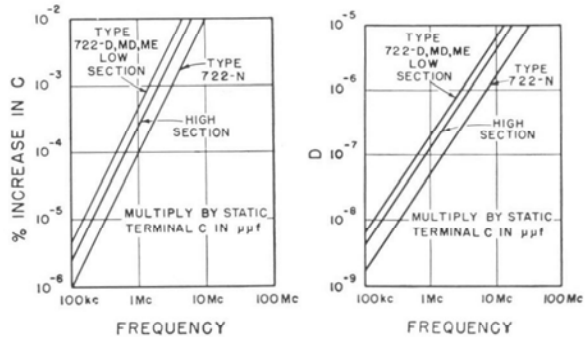



is given by the expression

$$C_e = \frac{C}{1 - \omega^2 LC} \approx C + \omega^2 LC^2 \quad (3)$$

Variations of  $C_e$  and  $D$  for TYPE 722 Precision Capacitors are given in Figure 2 as a function of frequency, for various settings.

2. FIXED SOLID-DIELECTRIC CAPACITORS

The same residual impedances shown in Figure 1 for air capacitors are present in solid-dielectric capacitors, but, because of a different mechanical structure and because the capacitance is concentrated in the solid dielectric, their relative magnitudes are different.

In addition, the so-called dielectric absorption caused by interfacial polarizations occurring in the dielectric at frequencies in the milli-cycle or micro-cycle range affect the low-frequency performance.

The effects of interfacial polarization in the dielectric are shown by the low-frequency portions of Figure 3, *a* and *b*. On these log-log plots the slope of the lines is characteristic of the dielectric material. At very low frequencies, the d-c leakage conductance adds a component to the dissipation factor, but does not affect capacitance. It is normally negligible, even at 10 cycles per second.

At high frequencies, the series resistance causes dissipation factor to increase as the 3/2 power of frequency, while the series inductance causes the fractional change in capacitance to increase as the square of frequency (See Equations 2 and 3).

FIGURE 3. The variation, with frequency, of capacitance, *a* (top), and dissipation factor, *b* (bottom), of a fixed solid-dielectric capacitor.

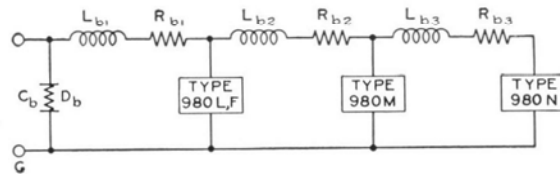
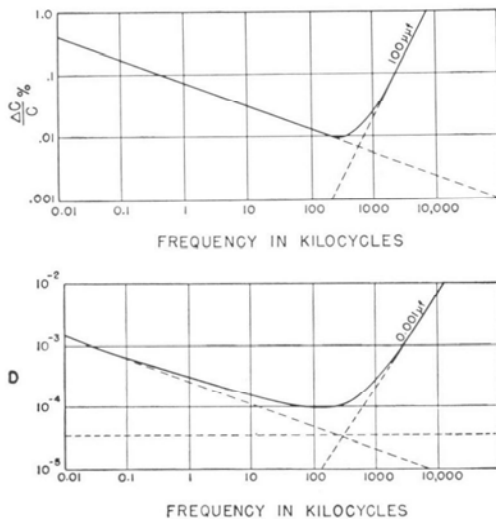

FIGURE 4. Equivalent circuit of a TYPE 219 Decade Condenser.

Fractional change in capacitance and absolute value of dissipation factor each have a minimum value, which occurs at a frequency that varies inversely with capacitance and that can be as low as 1 kc and as high as 10 Mc for capacitance values in the range from 1  $\mu\text{f}$  to 100  $\mu\text{f}$ . For small capacitances, where the effect of series resistance appears only at very high frequencies, a residual polarization, having a dissipation factor constant with frequency, sets a minimum value for dissipation factor.

In the following pages are described fixed solid-dielectric capacitors of various materials. The precision standard capacitors TYPE 509 use silvered mica as the dielectric material, as do TYPES 505 and 980, although these latter are not adjusted to the same order of accuracy as the TYPE 509. High-dielectric strength, low dielectric loss, and high dimensional stability make high-quality mica the best available solid dielectric for alternating-current standard capacitors. Silvered mica sheets with soft metallic foil interposed between sheets insure low resistance and stable contact between electrodes and the dielectric.

For use at d-c or extremely low frequencies, mica dielectric is at some disadvantage because of the relatively large increase of its d-c capacitance over the audio-frequency value. This increase is caused by interfacial polarizations having extremely long relaxation times.

Polystyrene exhibits the remarkable property of having dielectric constant and dissipation factor very nearly invariant with frequency, the total increase in d-c dielectric constant over the high-frequency value being only a small fraction of a percent (in contrast, mica exhibits a rise of the order of 30%). TYPE 980-A, -B, and -C Decade Capacitors are hermetically sealed capacitors, wound non-inductively with carefully processed polystyrene film.

When capacitors are assembled into decades, as in the TYPE 980 Decade-Capacitor Units, the residual impedances are increased by the switch and wiring. The assembling of several decades into a TYPE 219 or 1419 Decade Capacitor adds more series residuals and more terminal capacitance.



## TYPE 722 PRECISION CAPACITOR

**USES:** The TYPE 722 Precision Capacitor is a stable and precise variable air capacitor intended for use as a standard of capacitance.

It is widely used in a-c bridges, both as a built-in standard and as an external standard for substitution measurements. It is also used as a tuning capacitor in oscillators and frequency meters, and as a standard in electronic gauges, calibrators and other instruments. Where highest accuracy and stability are important, it is the standard of the industry.

**DESCRIPTION:** The capacitor assembly is mounted in a cast frame, which gives the unit rigidity. The frame, spacers, stator rods, and rotor shaft are made of the best available alloys of aluminum, which combine the mechanical strength of brass with the weight of aluminum. The plates are also of aluminum, so that all parts have the same temperature coefficient of linear expansion.

A worm drive is used to obtain the desired high precision of setting. In order to avoid the slight eccentricity that may occur when a worm gear is mounted on a shaft, the shaft and the worm are one accurately machined piece. The dial end of this worm shaft runs in a self-aligning ball bearing, while the other end is supported by an adjustable spring mounting. Sealed, self-lubricating ball bearings, lightly stressed, are used at the ends of the rotor shaft. Electrical connection to the rotor is made by means of a silver alloy brush bearing on a silver overlay drum to assure a positive electrical contact.



The preliminary assembly of the frame, shaft, and gears is motor driven to grind in the gears before final assembly to improve smoothness and concentricity.

- FEATURES:**
- High stability.
  - High precision of setting — one part in 25,000 of full scale; scale length is 19.2 feet.
  - High accuracy.
  - Low backlash.
  - Low temperature coefficient of capacitance.
  - Low dielectric losses.
  - Direct reading in capacitance.

### SPECIFICATIONS

**Capacitance Range:** Three stock models are listed below. A fourth model for use at high frequencies is described on page 153.

TYPE 722-D, direct reading in total capacitance; and TYPE 722-MD and TYPE 722-ME, direct reading in capacitance removed from the capacitor and intended for use in capacitance measurement by the direct substitution method. Ranges and accuracies are tabulated below.

Type	Capacitance Range, $\mu\text{mf}$	Direct-Reading Accuracy	Approx. Cap. at Zero Scale Setting
722-D	100 to 1150	$\pm 1 \mu\text{mf}$ or $\pm 0.1\%$	—
	25 to 115	$\pm 0.2 \mu\text{mf}$ or $\pm 0.1\%$	—
722-MD	0 to 1050	$\pm 1 \mu\text{mf}$ or $\pm 0.1\%$	1140 $\mu\text{mf}$
	0 to 105	$\pm 0.2 \mu\text{mf}$ or $\pm 0.1\%$	135
722-ME	0 to 105	$\pm 0.2 \mu\text{mf}$ or $\pm 0.1\%$	145
	0 to 10.5	$\pm 0.05 \mu\text{mf}$ or $\pm 0.1\%$	35

Capacitance is indicated by the readings of the dial and drum, visible through a window in the panel. Special models, including three-terminal designs, can be supplied to meet customers' specifications.

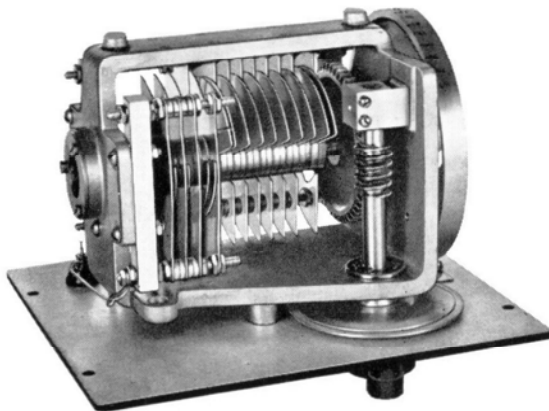

Interior view of the TYPE 722-ME Precision Capacitor.



**Rotor Plate Shape:** Semicircular for all models, to give a linear capacitance characteristic.  
**Correction Chart:** A correction chart is supplied giving

corrections at multiples of 1, 10 or 100  $\mu\mu\text{f}$ , depending on the total capacitance of the capacitor. Accuracies obtainable through the use of these charts are as follows:

Type	Range, $\mu\mu\text{f}$	Accuracy after correction is applied	
		Total Capacitance	Capacitance Differences
722-D	{ 100 to 1150 25 to 115	$\pm 0.1\%$ or $\pm 0.4 \mu\mu\text{f}^*$	$\pm 0.1\%$ or $\pm 0.8 \mu\mu\text{f}^*$
		$\pm 0.1\%$ or $\pm 0.08 \mu\mu\text{f}^*$	$\pm 0.1\%$ or $\pm 0.16 \mu\mu\text{f}^*$
722-MD	{ 0 to 1050 0 to 105	$\pm 0.1\%$ or $\pm 0.4 \mu\mu\text{f}^*$	$\pm 0.1\%$ or $\pm 0.8 \mu\mu\text{f}^*$
		$\pm 0.1\%$ or $\pm 0.08 \mu\mu\text{f}^*$	$\pm 0.1\%$ or $\pm 0.16 \mu\mu\text{f}^*$
722-ME	{ 0 to 105 0 to 10.5	$\pm 0.1\%$ or $\pm 0.08 \mu\mu\text{f}^*$	$\pm 0.1\%$ or $\pm 0.16 \mu\mu\text{f}^*$
		$\pm 0.1\%$ or $\pm 0.02 \mu\mu\text{f}^*$	$\pm 0.1\%$ or $\pm 0.04 \mu\mu\text{f}^*$

† When differences are taken from any zero worm-dial setting.

\* Whichever is greater.

**Overall Usable Accuracy:** The accuracies stated above can be attained in practice only if an acceptable standard technique is used by the operator to connect the capacitor into a measuring circuit. Otherwise, the usable accuracy at the capacitor terminals may be limited to approximately  $\pm 1 \mu\mu\text{f}$ . (See description on page 154 under TYPE 1401 or *General Radio Experimenter*, Vol.

XXI, No. 12, May 1947, for a complete discussion of connection errors.)

**Worm Correction Calibration:** Corrections for the slight residual eccentricity of the worm drive can be supplied for all models at an extra charge indicated in the price list. Mounted charts are supplied, which give the corrections to at least one more figure than the guaranteed accuracies, which are stated below.

Type	Range, $\mu\mu\text{f}$	Accuracy after worm correction is applied	
		Total Capacitance	Capacitance Differences
722-D	{ 100 to 1150 25 to 115	$\pm 0.1\%$ or $\pm 0.1 \mu\mu\text{f}^*$	$\pm 0.1\%$ or $\pm 0.2 \mu\mu\text{f}^*$
		$\pm 0.1\%$ or $\pm 0.02 \mu\mu\text{f}^*$	$\pm 0.1\%$ or $\pm 0.04 \mu\mu\text{f}^*$
722-MD	{ 0 to 1050 0 to 105	$\pm 0.1\%$ or $\pm 0.1 \mu\mu\text{f}^*$	$\pm 0.1\%$ or $\pm 0.2 \mu\mu\text{f}^*$
		$\pm 0.1\%$ or $\pm 0.02 \mu\mu\text{f}^*$	$\pm 0.1\%$ or $\pm 0.04 \mu\mu\text{f}^*$
722-ME	{ 0 to 105 0 to 10.5	$\pm 0.1\%$ or $\pm 0.02 \mu\mu\text{f}^*$	$\pm 0.1\%$ or $\pm 0.04 \mu\mu\text{f}^*$
		$\pm 0.1\%$ or $\pm 0.005 \mu\mu\text{f}^*$	$\pm 0.1\%$ or $\pm 0.01 \mu\mu\text{f}^*$

† When differences are taken from any zero worm-dial setting.

\* Whichever is greater.

**Maximum Voltage:** All models, 1000 volts, peak.  
**Dielectric Supports:** Bars of low-loss steatite support the stator assemblies, and conical polystyrene bushings insulate the terminals from the panel. Quartz bars, coated with silicone to prevent formation of a water film, can be supplied on special order. (See price list.)  
**Dielectric Losses:** The figure of merit,  $D_oC_o$  (dissipation factor times capacitance), when measured at 1 kc, is approximately  $0.03 \times 10^{-12}$  for steatite insulation and  $0.003 \times 10^{-12}$  for quartz.  
**Insulation Resistance:** Under standard conditions (23° C, 50% RH), greater than  $10^{12}$  ohms.  
**Residual Parameters:** Effective series inductance is approximately  $0.06 \mu\text{h}$  for all high-capacitance sections and  $0.10$  for low-capacitance sections. Effective series resistance at 1 Mc is approximately  $0.02\Omega$  for high-capacitance sections and  $0.03\Omega$  for low-capacitance sections. The series resistance varies as the square root of the frequency. Its effect is negligible below 100 kc.

**Frequency Characteristic:** See Figure 2, page 149, for plot of variation of capacitance with frequency.  
**Temperature Coefficient of Capacitance:** Approximately  $+0.002\%$  per degree Centigrade, for small temperature changes.  
**Backlash:** Less than one-half division, corresponding to 0.01% of full scale value. If the desired setting is always approached in the direction of increasing scale reading, no error from this cause will result.  
**Terminals:** Jack-top binding posts are provided. Standard  $\frac{3}{4}$ -inch spacing is used. The rotor terminal is connected to the panel and shield.  
**Mounting:** The capacitor is mounted on an aluminum panel finished in black crackle lacquer and enclosed in a shielded walnut cabinet. A wooden storage case with carrying handle is supplied.  
**Dimensions:** Panel,  $8 \times 9\frac{1}{8}$  inches; depth,  $8\frac{1}{8}$  inches.  
**Weight:**  $10\frac{1}{2}$  pounds;  $19\frac{3}{4}$  pounds with carrying case.

Type		Code Word	Price
722-D	Precision Capacitor.....	CRUEL	\$225.00
722-MD	Precision Capacitor.....	CYNIC	205.00
722-ME	Precision Capacitor.....	COUPE	210.00
Worm-Correction Calibration for any model*.....		WORMY	75.00

\* When ordering, use compound code word, CRUELWORMY, etc.

QUARTZ INSULATION

Any TYPE 722 Precision Capacitor can be obtained with quartz insulation.

Type		Code Word	Price
722-DQ	Type 722-D with Quartz Insulators.....	CRUELQUATZ	\$320.00
722-MDQ	Type 722-MD with Quartz Insulators.....	CYNICQUATZ	300.00
722-MEQ	Type 722-ME with Quartz Insulators.....	COUPEQUATZ	305.00



## TYPE 722-N

### PRECISION CAPACITOR

(FOR USE AT  
RADIO FREQUENCIES)

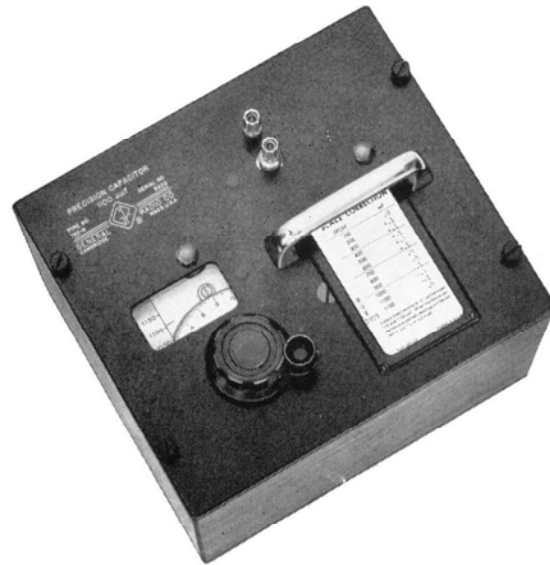

**USES:** This capacitor has been designed particularly for use as a standard at radio frequencies in series- or parallel-resonance methods of impedance measurement. It is also useful as a variable capacitor in radio-frequency bridges.

**DESCRIPTION:** The frame, bearing, and drive mechanism of this capacitor are identical with those used on the other TYPE 722 Precision Capacitors. The rotor and stator leads, however, are not brought out in the conventional manner. Connection is made at the center of both plate stacks to minimize residual inductance and resistance.

The rotor connection is made by spring-temper, silver-alloy brushes bearing on a silver-overlay disc.

**FEATURES:** The important features of this capacitor are its low metallic resistance and low inductance. Both of these quantities are about one-third the magnitude of those in the TYPE 722-D. The accuracy of calibration is as good and the dielectric losses nearly as low as in the other TYPE 722 Capacitors.

### SPECIFICATIONS

**Capacitance Range:** 100 to 1150  $\mu\mu\text{f}$ , direct reading.

**Standard Calibration Accuracy:** The capacitance, measured at 1 kc, is indicated directly in micromicrofarads by the dial and drum readings to  $\pm 1 \mu\mu\text{f}$  or  $\pm 0.1\%$ .

A correction chart is supplied giving corrections to 0.1  $\mu\mu\text{f}$  at multiples of 100  $\mu\mu\text{f}$ . By using these data the direct-reading accuracy is  $\pm 0.1\%$  or  $\pm 0.4 \mu\mu\text{f}$ , whichever is the greater, and the accuracy for capacitance differences is  $\pm 0.1\%$  or  $\pm 0.8 \mu\mu\text{f}$ , whichever is the greater.

**Worm Correction Calibration:** A worm correction can be supplied on special order. (See price list.) A mounted chart is supplied giving the corrections to at least one more figure than the guaranteed accuracy stated below.

When the worm correction is used, the capacitance can be determined within  $\pm 0.1\%$  or  $\pm 0.1 \mu\mu\text{f}$ , whichever is the greater, and capacitance differences can be measured to an accuracy of  $\pm 0.1\%$  or  $\pm 0.2 \mu\mu\text{f}$ , whichever is the greater.

**Dielectric Supports:** Two bars of steatite support the stator assembly, and a third bar insulates the high term-

inal from the panel. Quartz insulation can be supplied on a special order. See price list below.

**Dielectric Losses:** The figure of merit,  $D_v C_o$  (dissipation factor times capacitance), when measured at 1 kc, is approximately  $0.04 \times 10^{-12}$  for steatite insulation.

**Other Residual Parameters:** The series metallic resistance is about 0.008 ohm at 1 megacycle and increases directly as the square root of the frequency. The dielectric and metallic losses are approximately equal at a setting of 1000  $\mu\mu\text{f}$  and a frequency of 1 Mc.

The series inductance is approximately 0.024  $\mu\text{h}$ . The increase in capacitance caused by this inductance reaches 10% at a setting of 1000  $\mu\mu\text{f}$  and a frequency of 10 Mc.

At smaller capacitance settings the effects of residual parameters are less. The equal division of losses occurs at 20 Mc for a setting of 100  $\mu\mu\text{f}$  and the 10% capacitance rise occurs at 30 Mc for the same setting.

**Frequency Characteristic:** See Figure 2, page 149, for plot of variation of capacitance with frequency.

**Dimensions:** Panel, 8 x 9  $\frac{1}{8}$  inches; depth, 8  $\frac{1}{8}$  inches.

**Net Weight:** 11  $\frac{1}{4}$  pounds; 20  $\frac{1}{2}$  pounds with carrying case.

Other specifications are identical with those of TYPE 722-D, page 152.

Type		Code Word	Price
722-N	100 to 1150 $\mu\mu\text{f}$ , direct reading	BOXER	\$195.00
722-NQ	Type 722-N with Quartz Insulation	BOXERQUATZ	275.00
Worm-Correction Calibration		WORMY	50.00

When ordering, use compound code word, BOXERWORMY.



## TYPE 1401 STANDARD AIR CAPACITOR



**USES:** This unit is a two-terminal fixed air standard for laboratory use. It supplements the TYPE 509 series of fixed mica standard capacitors and provides a low loss standard in the low-capacitance range.

**DESCRIPTION:** The plate assemblies are supported by a low loss (96% quartz) mounting plate, attached to an aluminum casting. This casting, together with the cylindrical aluminum case, provides a dust-free enclosure and a complete shield. The low, or ground, side of the capacitor is connected to this shield. Three supporting rods are used for each of the plate assemblies, assuring a high degree of rigidity and stability. As in the TYPE 722 Precision Capacitor, all plates, rods and spacers are aluminum to reduce thermal stresses.

**FEATURES:** ➤ High accuracy and stability.  
 ➤ Low temperature coefficient.  
 ➤ Convenient size.

### SPECIFICATIONS

**Capacitance:** Four sizes: 100, 200, 500, and 1000  $\mu\text{f}$ .  
**Terminals:** TYPE 938 jack-top binding posts on standard  $\frac{3}{4}$ -inch spacing. Internal ground on one post. A pair of double-ended plugs is supplied to facilitate connection to jack-top binding posts. If these plugs are added to the capacitor, the certified value of the capacitance is increased by 0.35  $\mu\text{f}$  when the unit is plugged into General Radio TYPE 938 Binding Posts with one post grounded as on the TYPE 716-C Capacitance Bridge.  
**Accuracy:** Each capacitor is adjusted to  $\pm (0.1\% + 0.1 \mu\text{f})$  at 1 kc, under ASTM standard laboratory conditions (23° C, 50% RH) and a certificate of calibration is included. This accuracy applies for direct substitution measurements when connection to the capacitor is made by fine wires: Lead to the low binding post through its hole and parallel to the panel. High lead bent so it approaches the high binding post top perpendicular to the panel. Initial balance is made with this wire spaced  $\frac{1}{4}$ -inch, and final balance with it touching the top of the post. For other methods of connection, an uncertainty approaching 1  $\mu\text{f}$  may be introduced.  
**Maximum Voltage:** For TYPES 1401-A, B, C and D the maximum peak voltage is 1500, 1200, 900 and 700 respectively.  
**Dielectric Supports:** Plate assemblies are supported by a low-loss (96% quartz) material. Polystyrene bushings insulate the binding posts.  
**Residual Impedances:** The series inductance of all units is approximately 0.05  $\mu\text{h}$ . The variation in effective terminal capacitance caused by this inductance is shown in the accompanying plot.

The metallic resistance of all units is approximately .027  $\Omega$  at one megacycle. The series resistance varies as

the square root of frequency above about 100 kc.  
**Dissipation Factor:** For TYPES 1401-A, -B, -C, -D, not greater than 0.00004, 0.00003, 0.00002, and 0.00001, respectively, at 1 kc and standard laboratory conditions (23° C, 50% RH).  
**Dimensions:** Diameter,  $3\frac{1}{4}$  inches; height, over-all,  $4\frac{1}{4}$  inches. **Net Weight:** One pound.

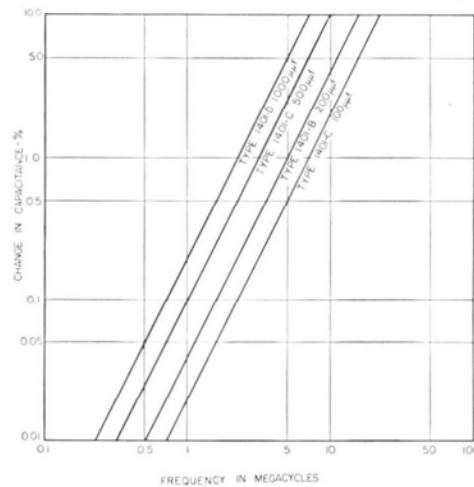

Variation with frequency of effective terminal capacitance due to residual inductance for each unit.

Type	Capacitance	Code Word	Price
1401-A	100 $\mu\text{f}$ .....	HABIT	\$37.00
1401-B	200 $\mu\text{f}$ .....	HONOR	43.00
1401-C	500 $\mu\text{f}$ .....	HOLLY	48.00
1401-D	1000 $\mu\text{f}$ .....	HANDY	53.00

Note: TYPE 1420 Variable Air Capacitors can be found on page 230 in the Parts and Accessories section of this catalog.



## TYPE 505 CAPACITOR

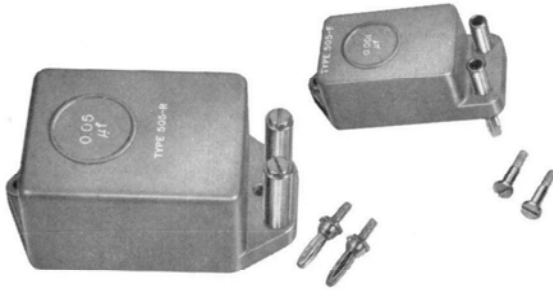

The TYPE 505 Capacitors are used as secondary laboratory standards and as high-quality circuit elements.

The capacitor unit consists of a silvered-mica and foil pile, which is spring-held by a heavy metal clamp for mechanical rigidity. This clamp is not connected to either capaci-

tor terminal but is left floating. Both outside foils are connected together. After aging, the capacitor unit is placed in the low-loss phenolic case, with silica gel to provide continuous desiccation, with ground cork to absorb shock, and then sealed with wax.

**FEATURES:** ▶ Small, convenient, and accurate.  
 ▶ Has both screw- and plug-type terminals.  
 ▶ Low temperature coefficient of capacitance.  
 ▶ Units are heated to eliminate moisture before sealing, and internal humidity is held to low value by desiccant.  
 ▶ Low-loss case to reduce dielectric loss and leakage conductance.  
 ▶ Electrodes are silvered on the mica films, and connections made to the silvered surfaces by soft metal foils.

### SPECIFICATIONS

**Accuracy:**  $\pm 0.5\%$  or  $\pm 3 \mu\text{f}$ , whichever is the larger.

**Temperature Coefficient:** Approximately  $+0.0035\%$  per degree Centigrade between  $10^\circ$  and  $50^\circ$  Centigrade. Calibration is made at  $23^\circ \text{C}$ ., at a frequency of 1 kc.

**Dissipation Factor:** 0.0003 for 1000  $\mu\text{f}$  and higher; 500  $\mu\text{f}$ , 0.00035; 200  $\mu\text{f}$ , 0.0004; 100  $\mu\text{f}$ , 0.0005.

**Frequency Characteristics:** See plots below. Series inductance is approximately 0.055  $\mu\text{h}$  for units in small case and 0.085  $\mu\text{h}$  for large case. Series resistance at 1 Mc is approximately 0.03 ohm for small case and 0.05 ohm for large case, varying as square root of frequency above 100 kc.

**Leakage Resistance:** Greater than 100,000 megohms, when measured at 500 volts, except for the TYPES 505-U and 505-X, for which it is greater than 50,000 and 20,000 megohms, respectively.

**Maximum Voltage:** See table. At higher frequencies the allowable voltage decreases and is inversely proportional to the square root of the frequency. These limits

correspond to a temperature rise of  $40^\circ$  Centigrade for a power dissipation of 1 watt for the small case and 2.5 watts for the large case.

**Terminals:** Screw terminals spaced  $\frac{3}{4}$  inch apart. Two TYPE 274-P Plugs are supplied with each capacitor. High terminal (inside foil) is marked H.

**Mounting:** Mica-filled, low-loss phenolic cases.

**Dimensions:** See sketch. Over-all height,  $1\frac{5}{8}$  inches for large case, 1 inch for small case, exclusive of plugs.

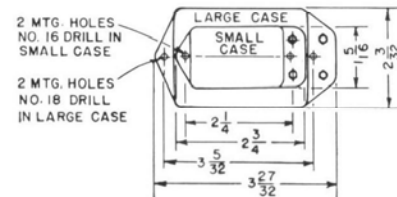

Type	Capacitance	Maximum Peak Volts	Frequency Limit for Max. Volts	Weight in Ounces	Code Word	Price
505-A	100 $\mu\text{f}$	700	2000kc	4	CONDENALLY	\$ 7.00
505-B	200 $\mu\text{f}$	700	1000	4	CONDENBELL	6.00
505-E	500 $\mu\text{f}$	500	1000	4	CONDENCOAT	5.25
505-F	0.001 $\mu\text{f}$	500	800	4	CONDENDRAM	5.25
505-G	0.002 $\mu\text{f}$	500	400	5	CONDENEYRE	5.25
505-K	0.005 $\mu\text{f}$	500	160	5	CONDENFACT	6.50
505-L	0.01 $\mu\text{f}$	500	80	5	CONDENGIRL	8.50
505-M	0.02 $\mu\text{f}$	500	40	6	CONDENHEAD	9.00
*505-R	0.05 $\mu\text{f}$	500	40	11	CONDENCALM	13.50
*505-T	0.1 $\mu\text{f}$	500	20	12	CONDENCROW	16.50
*505-U	0.2 $\mu\text{f}$	500	10	13	CONDENWIPE	24.00
*505-X	0.5 $\mu\text{f}$	500	4	15	CONDENWILT	52.50

\* Mounted in large case.

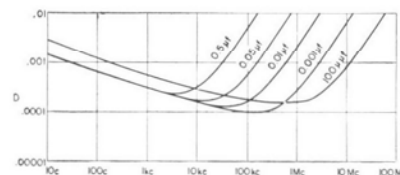
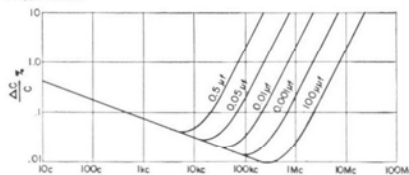

(Left) Change in capacitance as a function of frequency for TYPE 505 Capacitors. These changes are referred to the values which the capacitors would have if there were neither interfacial polarization nor series inductance. Since the capacitors are adjusted to their nominal values at 1 kc, the 1-kc value on the plot should be used as a basis of reference in estimating frequency errors. (Right) Dissipation factor as a function of frequency.



## TYPE 509 STANDARD CAPACITOR

**USES:** These capacitors are fixed standards for laboratory use. When they are used in conjunction with a TYPE 722-D or a TYPE 722-M Precision Capacitor in a parallel substitution method of measurement, precise measurements of capacitance up to several microfarads can be made. For capacitor manufacturers who maintain a capacitance standardization laboratory, a set of TYPE 509 Standard Capacitors, used with a TYPE 716-C Capacitance Bridge, is recommended.

**DESCRIPTION:** The TYPE 509 Standard Capacitor uses a silvered mica and foil stack similar to that used in the TYPE 505; units are selected for low dissipation factor and are put through an additional aging process. The final accuracy and stability are thus exceptionally good. The units are mounted in cast aluminum cases, with silica gel to provide continuous desiccation, and are sealed with high-temperature potting wax. The cases are furnished with jack-top binding posts. Case is grounded to one terminal.



**FEATURES:** ➤ Stability for the first year within  $\pm 0.05\%$  is obtained by careful, controlled construction and aging.  
 ➤ A calibration certified within  $\pm 0.1\%$ , is furnished with each unit.  
 ➤ Plug-in terminals are arranged for convenience in using the capacitors. Several units can be stacked one upon the other without the use of leads and without cumulative error.

### SPECIFICATIONS

**Accuracy of Adjustment:** Within  $\pm 0.25\%$  of the nominal capacitance value engraved on the case.

**Accuracy of Calibration:** After each capacitor has been aged, adjusted, and mounted, its capacitance is carefully measured and the value of capacitance at 1 kc and  $23^\circ\text{C}$ , accurate within  $\pm 0.1\%$ , is entered on a certificate of calibration which is packed with each unit.

**Stability:** Over reasonable periods of time (at least one year) each capacitor will maintain its calibrated value within  $\pm 0.05\%$ .

**Temperature Coefficient:** Approximately  $+0.0035\%$  per degree Centigrade between  $10^\circ$  and  $50^\circ$  Centigrade.

**Dissipation Factor:** Less than 0.0003 when measured at 1 kc and  $23^\circ$  Centigrade. See *D* curves on previous page.

**Frequency Characteristics:** See plots for TYPE 505 on previous page. Values of series inductance and series resistance at 1 Mc are given in the table below. This resistance varies as the square root of the frequency for frequencies above 100 kc.

**Leakage Resistance:** Greater than 100,000 megohms

when measured at 500 volts, except for the TYPES 509-U, 509-X, and 509-Y, for which it is greater than 50,000, 20,000, and 10,000 megohms, respectively.

**Maximum Voltage:** 500 volts peak at frequencies below the limiting frequencies tabulated below. At higher frequencies the allowable voltage decreases and is inversely proportional to the square root of the frequency. These limits correspond to a temperature rise of  $40^\circ$  Centigrade for a power dissipation of 3 watts for the small case and 5 watts for the large.

**Mounting:** Cast aluminum cases with rubber feet.

**Terminals:** Two jack-top binding posts spaced  $\frac{3}{4}$  of an inch apart are mounted on the case. One terminal is grounded, and the other one is insulated by means of a polystyrene bushing. Two TYPE 274-P Plugs are supplied with each capacitor.

**Dimensions:** Small case, (length)  $4\frac{7}{8}$  inches x (width)  $2\frac{1}{2}$  inches x (height)  $1\frac{7}{8}$  inches, over-all. Large case, (length) 6 inches x (width)  $3\frac{3}{4}$  inches x (height)  $2\frac{3}{8}$  inches, over-all.

Type	Capacitance in $\mu\text{f}$	Maximum Peak Volts	Frequency Limit in kc for Max. Volts	Series Inductance in $\mu\text{h}$	Resistance in ohms at 1 Mc	Weight in pounds	Code Word	Price
509-F	0.001	500	2500	0.065	0.040	$1\frac{1}{4}$	GOODCONBOY	\$ 30.00
509-G	0.002	500	1250	0.065	0.040	$1\frac{1}{4}$	GOODCONBUG	30.00
509-K	0.005	500	500	0.035	0.020	$1\frac{3}{8}$	GOODCONCAT	30.00
509-L	0.01	500	250	0.035	0.020	$1\frac{3}{8}$	GOODCONDOG	30.00
509-M	0.02	500	125	0.035	0.020	$1\frac{3}{8}$	GOODCON EYE	32.50
*509-R	0.05	500	80	0.040	0.025	$2\frac{3}{8}$	GOODCONPIG	39.00
*509-T	0.1	500	40	0.040	0.025	$2\frac{5}{8}$	GOODCONROD	42.00
*509-U	0.2	500	20	0.040	0.025	$2\frac{3}{4}$	GOODCONSIN	50.00
*509-X	0.5	500	8	0.040	0.025	$3\frac{1}{4}$	GOODCONSUM	76.00
*509-Y	1.0	500	4	0.050	0.030	$3\frac{5}{8}$	GOODCONTOP	118.00

\* Mounted in large case.





## TYPE 1419-A POLYSTYRENE DECADE CAPACITOR

**USES:** The TYPE 1419-A Polystyrene Decade Capacitor is particularly useful in research and development work on computer and integrator circuits and on low-level a-c amplifiers, because of its very low dielectric absorption. Its constancy of capacitance and dissipation factor as a function of frequency also make it extremely useful in measuring circuits and as a component in filters and tuned circuits. The high insulation resistance and low dielectric absorption make a nearly ideal capacitor for d-c work.

**DESCRIPTION:** This new decade capacitor is based on development work and manufacturing experience by General Radio since 1940. The individual capacitor units are non-inductively wound and heat-stabilized, resulting in units of long-time stability approaching that of the best silvered-mica capacitors. The tape used for the dielectric is specially prepared of purified high-molecular-weight polystyrene, having very high resistance and freedom from polarization. Hermetic sealing with Teflon feed-through insulators assures high performance even under adverse humidity conditions. Newly developed switches have very low capacitance and loss, achieved through the use of a minimum quantity of low-loss supporting insulation.

Each decade uses four capacitors, whose capacitance magnitudes are in the ratio 1-2-2-5, and which are connected in parallel combinations by the switch to produce decade steps.



- FEATURES:**
- High insulation resistance.
  - Low dielectric absorption.
  - Low dielectric loss.
  - Capacitance and dissipation factor vary only slightly with frequency.
  - Completely shielded and hermetically sealed.
  - All insulation of highest available quality.
  - Three-terminal construction.
  - Excellent long-time stability.

### SPECIFICATIONS

**Capacitance Range:** .001 $\mu$ f to 1.11 $\mu$ f in steps of .001 $\mu$ f. The three decades have steps of .001, .01, and .1 $\mu$ f respectively.

**Zero Capacitance:** Approximately 35 $\mu$ f.

**Accuracy:** Individual capacitors are adjusted to an accuracy of  $\pm 1\%$ . The capacitance at the terminals, less the zero capacitance, is within  $\pm 1\%$  of indicated value for any setting.

**Dissipation Factor:** Dissipation factor caused by dielectric loss is less than 0.0002 at all frequencies above 100 cycles. At high frequencies, series metallic resistance increases the dissipation factor as shown by the curves on page 159.

**Insulation Resistance:** Greater than 1 megamegohm ( $10^{12}$  ohms), when measured at 100 volts, 23° C, and 50% RH.

**Maximum Voltage:** 500 volts d-c or peak.

**Frequency Characteristics:** The d-c capacitance is equal to the 1-kc value within 0.1%. At high frequencies, series inductance causes capacitance to increase as shown by the curves on page 159.

**Dielectric Absorption:** See Voltage Recovery.

**Voltage Recovery:** The voltage recovery at the terminals is less than 0.1% of the original charging voltage, after a charging period of one hour and a 10-second discharge through a resistance equal to one ohm per volt of charging.

**Mounting:** Aluminum panel and cabinet.

**Dimensions:** (Length) 13 x (width) 4 $\frac{5}{16}$  x (depth) 5 inches, over-all.

**Net Weight:** 8 $\frac{3}{8}$  pounds.

Type	Code Word	Price
1419-A   Decade Capacitor.....	BIGOT	\$195.00



## TYPE 980 DECADE CAPACITOR UNIT

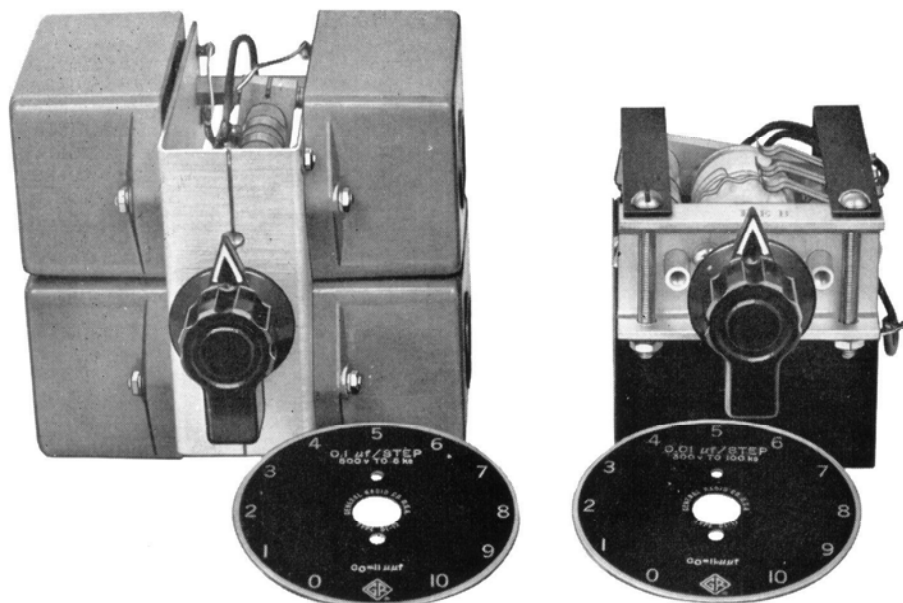

**USES:** The TYPE 980 Decade Capacitor Units are compact, convenient assemblies of high-grade capacitors mounted on an eleven-point switch to give a total capacitance variation of 10:1 in ten equal increments. They can be built into tuned circuits, wave filters, oscillators, analyzers, amplifiers, equalizers, and other permanent or experimental equipment.

Decades are available in three different dielectric materials: paper, for uses where dissipation factor is not critical; silvered mica for better dissipation factor and use in higher ambient temperatures; and polystyrene, for applications requiring very low dielectric absorption and constancy of both capacitance and dissipation factor as a function of frequency.

**DESCRIPTION:** Each decade consists of four capacitors of magnitudes in the ratio of 1, 2, 2, 5. The switch selects parallel combinations to give all integral values between 1 and 10.

The switch is rigidly constructed and includes a detect mechanism for positive location of position. The switch dielectric, includ-

ing the shaft, is heat-resistant, cross-linked polystyrene. Contacts are made by cams bearing on phosphor-bronze springs, the whole contact structure being heavily silver plated.

Units are furnished complete with knob, photo etched dial plate, and switch stops. The switch, with dial plate and knobs, is available separately (see price list below).

**FEATURES:** ➤ All component capacitors are carefully selected and aged for maximum stability with time.

➤ Paper-dielectric units are thoroughly impregnated with molten ceresin, one of the most efficient sealers against moisture. Winding is non-inductive with the foil projecting at each end of the roll, which minimizes dissipation factor and residual inductance.

➤ Mica-dielectric decades use silvered mica molded elements for low-capacitance decades and TYPE 505 units for the TYPE 980-F.

➤ Polystyrene decades have high insulation resistance, low dielectric absorption and low losses.

### SPECIFICATIONS

**Accuracy:** Capacitance increments on all units are within  $\pm 1\%$  from zero position when measured at 1 kc except the TYPE 980-L, which is accurate within  $\pm 2\%$ . The units are checked with the switch mechanism high, electrically, and the common lead and case grounded. The zero capacitance of all units is  $10\mu\mu\text{f}$  and must be

added to the switch settings to give the total capacitance.

**Dielectric:** See table.

**Dissipation Factor:** See table.

**Frequency Characteristics:** See plot page 159. The rise in both capacitance and dissipation factor is caused at low



Panel space and mounting dimensions of TYPE 980 Decade-Capacitor Units; for depth behind panel, see Dimensions.

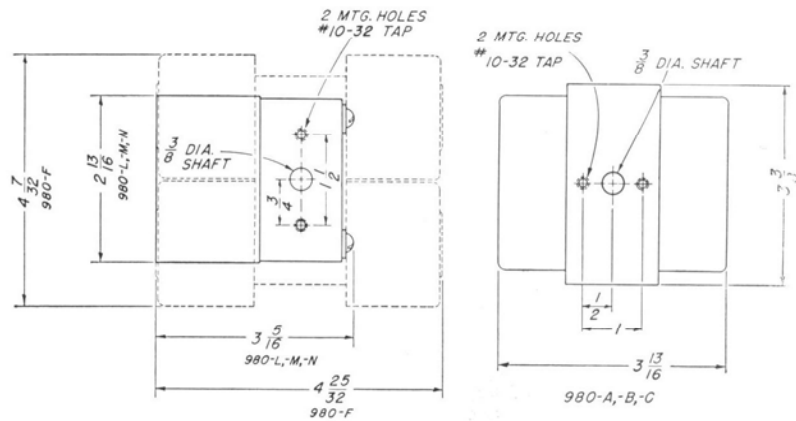

frequencies by interfacial polarization and at high frequencies by series inductance and resistance.  
**Maximum Voltage:** 500 volts peak for all units (except 980-L which is rated at 300 volts) at frequencies below the limiting frequencies tabulated below. At higher frequencies the allowable voltage decreases and is inversely proportional to the square root of the frequency. These limits correspond to a temperature of 40° Centigrade for a power dissipation of 2.5 watts for the TYPE 980-F and 3.5 watts for all other units.

**Terminals:** Flexible insulated leads are provided.

**Mounting:** Machine screws for attaching the decade to a panel are supplied.

**Dimensions:** Panel space, see accompanying sketch; depth behind panel, TYPES 980-A, -B, -C,  $3 \frac{1}{8}$  inches; TYPES 980-F, -L, -M, -N,  $4 \frac{1}{16}$  inches.

**Net Weight:** TYPES 980-A, -B, -C, 2 pounds, 2 ounces; TYPE 980-F, 3 pounds, 12 ounces; TYPE 980-L, 1 pound, 10 ounces; TYPES 980-M and -N, 1 pound, 8 ounces.

Type	Capacitance	Dielectric	Dissipation Factor at 1 kc and 23° C	Frequency Limit in Kc for Max. Voltage	Code Word	Price
980-A	1.0 $\mu$ f in 0.1 $\mu$ f steps	Polystyrene	Less than 0.0003	1	AVAST	\$66.00
980-B	0.1 $\mu$ f in 0.01 $\mu$ f steps	Polystyrene	Less than 0.0003	100	AVERT	51.00
980-C	0.01 $\mu$ f in 0.001 $\mu$ f steps	Polystyrene	Less than 0.0003	1000	AVOID	57.00
980-F	1.0 $\mu$ f in 0.1 $\mu$ f steps	Mica	Less than 0.0005	5	ACUTE	128.00
980-L	1.0 $\mu$ f in 0.1 $\mu$ f steps	Paper	Less than 0.010	1	ADAGE	28.00
980-M	0.1 $\mu$ f in 0.01 $\mu$ f steps	Mica	Less than 0.001	100	ADDER	42.00
980-N	0.01 $\mu$ f in 0.001 $\mu$ f steps	Mica	Less than 0.001	1000	ADDLE	26.00
980-PI	Switch only				SWITCHBIRD	11.00

Other decade units: Decade Resistors, page 170. Decade Inductors, page 165.

(Left) Typical plot of change in capacitance at maximum setting of each decade as a function of frequency. The capacitance curves are referred to the value the capacitor would have if there were no interfacial polarization and no series inductance. Since the capacitors are adjusted to their rated accuracy at 1 kc, the 1-kc value on the plots should be used as a basis of reference in estimating the frequency error. (Right) Typical plot of dissipation factor as a function of frequency.

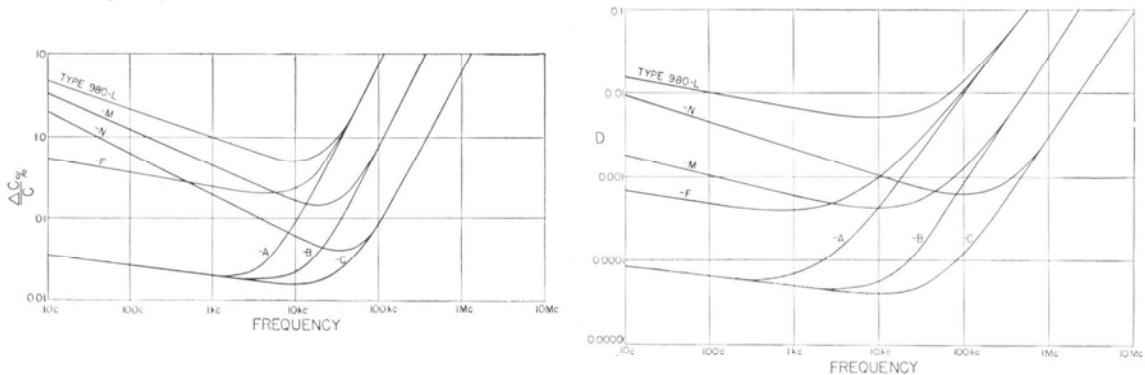



## TYPE 219 DECADE CONDENSER



**USES:** The TYPE 219 Decade Condensers find uses in every laboratory as tuned circuit elements, bridge impedances, filter elements, or as components of any circuit where a wide-range variable capacitor is necessary.

**DESCRIPTION:** The TYPE 219 Decade Condensers are assemblies of three TYPE 980 Decade-Capacitor Units mounted in a shielded cabinet. Each decade has eleven positions, 0 to 10 inclusive, so that the decades overlap. A positive detent mechanism allows the switch to be set accurately.

- FEATURES:**
- A wide range of direct-reading capacitance values.
  - Accuracy sufficient for most laboratory work.
  - The zero capacitance has been kept at a minimum, and its value is marked on each box for ready reference.
  - Dissipation factor has been held low by employing silvered-mica capacitors on all decades except the 0.1-microfarad decade of the TYPE 219-M.
  - Mica dielectric is used throughout the TYPE 219-K, which can therefore be used where the comparatively high losses of paper capacitors cannot be tolerated.
  - Low-loss switches.

### SPECIFICATIONS

**Accuracy:** All units are accurate for capacitance increments from zero position within  $\pm 1\%$ , except the 0.1-microfarad decade of the TYPE 219-M which is within  $\pm 2\%$ . The zero capacitance of the TYPE 219-K is  $46 \mu\mu\text{f}$  and of the TYPE 219-M is  $41 \mu\mu\text{f}$ .

**Dissipation Factor:** The dissipation factor for the individual decades is given in the specifications for the TYPE 980 Decade-Capacitor Units.

**Maximum Voltage:** 500 volts except for the highest decade in TYPE 219-M, where it is 300 volts.

**Frequency Characteristics:** The variation of capacitance and dissipation factor with frequency is similar to that shown on page 159 for TYPE 980 Decade-Capacitor Units, modified by the additional residual impedances shown in the accompanying sketch.

**Terminals:** Standard jack-top binding posts with a  $\frac{3}{4}$ -inch spacing are used. The shield is connected to the "G" terminal.

**Mounting:** The decades are assembled on an aluminum panel and mounted in a shielded walnut cabinet.

**Dimensions:** TYPES 219-K and 219-M, (length)  $13\frac{3}{4}$  x (width)  $5\frac{1}{2}$  x (height)  $5\frac{7}{8}$  inches.

**Net Weight:** TYPE 219-K,  $10\frac{3}{4}$  pounds; TYPE 219-M,  $5\frac{5}{8}$  pounds.

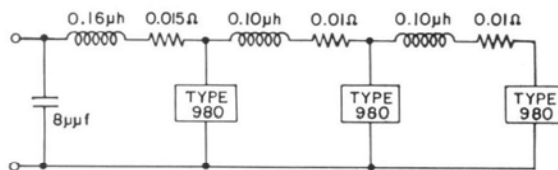

Residual impedances in the TYPE 219 Decade Condenser.

Type	Capacitance	No. of Dials	Type 980 Decades Used	Code Word	Price
219-K	1.110 $\mu\text{f}$ in 0.001 $\mu\text{f}$ steps.....	3	F, M, N	CROSS	\$220.00
219-M	1.110 $\mu\text{f}$ in 0.001 $\mu\text{f}$ steps.....	3	L, M, N	BRIER	120.00

See page 157 for decade capacitor with polystyrene dielectric.

# STANDARD INDUCTORS

The desirable attributes of any inductor to be used as a laboratory standard include:

- (1) High stability of inductance value.
- (2) Small variation of inductance with frequency.
- (3) Small variation of inductance with current.
- (4) High ratio of inductive reactance to resistance at the desired operating frequency.
- (5) Low temperature coefficient.
- (6) Reasonable physical size.
- (7) High degree of astaticism.

On the following pages are described a number of both fixed and variable inductors representing different economic compromises among the above factors.

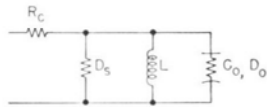

FIGURE A. Equivalent circuit of an air-cored inductor  $L$ .

## AIR-CORED INDUCTORS

High stability, low temperature coefficient, and negligible variation of inductance with current are best met by toroidal air-cored inductors, as exemplified by the TYPE 1482 Standard Inductors, whose symmetrical and rigid coil construction has proved to be stable over several years to better than 0.02 percent. The variation of series inductance,  $L$ , with frequency is a dual phenomenon that gives a minimum  $L$  somewhere between 200 c and 2 kc. At frequencies so low that  $Q$  is less than unity the effect of eddy currents predominates, and causes a decrease in  $L$  with increasing  $f$ . At higher frequencies, where  $Q$  exceeds unity, the effect of the distributed capacitance,  $C_o$ , of the coil predominates which causes  $L$  to increase with  $f$ . For frequencies well below the resonant  $f_o$  value the fractional increase in  $L$  due to  $C_o$  is approximately

$$\frac{\Delta L}{L} = \left( \frac{f}{f_o} \right)^2 = \omega^2 L C_o.$$

No variation of inductance with current occurs, and an air-cored inductor can be considered as an ideally linear circuit element.

The losses in an air-cored inductor are (a) an "ohmic" or  $I^2R_c$  loss from the series resistance of the winding, (b) a loss in the copper caused by eddy currents, and (c) dielectric losses in the insulation. An equivalent circuit taking these losses into account is shown in Figure A.

The effects of the various loss components are most easily represented by the plot of dissipation factor against frequency, Figure B. In logarithmic coordinates, the three dissipation-factor components of an air-core inductor can all be represented by straight lines as shown. The component,  $D_c$ , caused by the d-c resistance of the winding, varies inversely with frequency, while  $D_s$  due to eddy-current loss in the copper (and associated with skin-effect), is directly proportional to the frequency. The dissipation factor,  $D_o$ , of the distributed capacitance of the winding produces  $D_d$ , which is proportional to the square of the frequency within the significant range where  $D_o$  is independent of frequency. Note that  $D_d$  reaches the value  $D_o$  at  $f_o$ . The total dissipation factor,  $D$ , is the sum of these three components and has a minimum value which occurs well below the natural frequency,  $f_o$ , of the inductor.

It will be observed that at low frequencies the dissipation factor,  $D$ , is determined entirely by series re-

sistance, while at high frequencies the eddy current and dielectric losses predominate.

The minimum value of dissipation factor obtainable depends upon the geometry of the coil and upon the diameter of the wire. Insulated stranded wire (Litzendraht) is frequently employed to reduce  $D_s$  by using small individual wire diameters.

## IRON-CORED INDUCTORS

A larger inductance can be obtained in a given volume, or with a given amount of copper, if a core material of high permeability is used. The term "iron" is used loosely and generically to identify such ferromagnetic materials, although these materials are highly developed special alloys, in sheet, strip, or bonded granular form.

The economy in coil construction resulting from the use of "iron" cores is obtained with some sacrifice of performance in an inductor used as a calibrated standard. Stability is ordinarily reduced, since the inductance depends not only on geometry but also on the permeability of the core material. This permeability will vary somewhat with current, because of its inherent change with magnetizing force, and may also be subject to a slight aging. By proper design and choice of core material, as exemplified by the TYPES 940, 1490, and 1481, inductors satisfactory as secondary standards and as adjustable decade elements can be realized.

In an iron-cored inductor, lower values of  $D_c$  and  $D_s$  can be obtained, due to the increase of effective permeability, while  $D_o$  remains unchanged and  $f_o$  is reduced somewhat. Three other linear core components of dissipation factor must be added to the winding components shown in Figure B. Eddy currents in the core produce a component,  $D_e$ , which, like  $D_s$ , is directly proportional to the frequency and which is minimized in a dust core made by molding fine iron powder in an insulating binder. However, by the use of fine wire,  $D_s$  can be made negligible compared to  $D_e$ . The hysteresis component of dissipation factor,  $D_h$ , is independent of frequency but, since it is proportional to the magnetizing force, it becomes vanishingly small as the operating level approaches zero (initial permeability). The relatively small component,  $D_r$ , caused by residual losses in the iron is constant with frequency and, like  $D_h$ , would be represented by a horizontal line in Figure B.

FIGURE B. Dissipation factor variation with frequency showing the relative contributions of the several components.

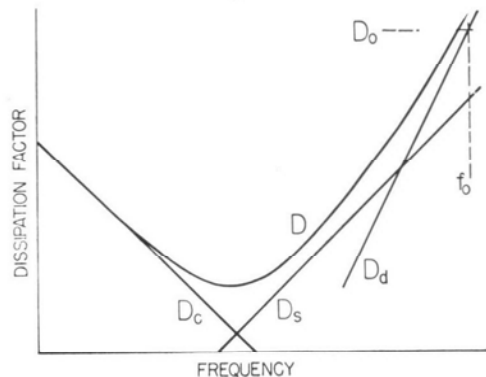



## TYPE 1482 STANDARD INDUCTOR

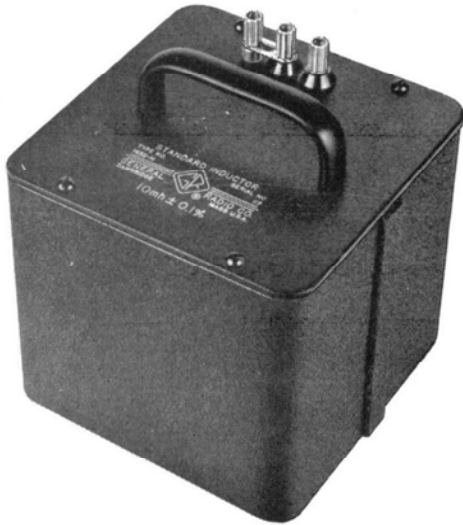

**USES:** The Type 1482 Standard Inductor is an accurate and highly stable standard of self-inductance for use as a primary standard in the laboratory and as a precise working standard in impedance measurements at audio frequencies.

**DESCRIPTION:** Each inductor is a symmetrically wound toroid on a ceramic core. It has a negligible external magnetic field and essen-

tially no pick-up from external fields. The inductor is hermetically sealed in a mixture of ground cork and silica gel, after which the whole assembly is cast with a potting compound into a cubical aluminum case.

Three terminals are provided, two for the inductor leads and the third connected to the case to afford either a two- or three-terminal standard. Prior to calibration these inductors are thermally aged to equalize winding strains. Calibrations are made with the low terminal of the winding grounded to case by a metal link between the two binding posts. Calibrations are made at 100 c in terms of a similar inductor, certified by the National Bureau of Standards. An individual calibration certificate gives corrections applicable at 200 c, 500 c and 1 kc.

- FEATURES:**
- High stability of inductance.
  - Free from mounting strains and humidity errors.
  - Inductance independent of voltage.
  - Precisely adjusted and accurately calibrated at specified room temperature.
  - Highly astatic, and electrostatically shielded.
  - Low and known temperature coefficient.

### SPECIFICATIONS

**Inductance Range:** See price table.

**Temperature Coefficient of Inductance:** Approximately 30 parts in  $10^6$  per degree C. Minute temperature corrections may be computed from d-c resistance.

**Accuracy:** Nominal limits of adjustment, see table. Limits of measured certificate value, equivalent to National Bureau of Standards certification, see table.

**D-C Resistance:** See table for representative values.

**Low-Frequency Dissipation Factor:** At low frequencies, the dissipation factor (essentially from d-c resistance) is given approximately by  $D = K/f$ . See table for  $K$ .

**Resonant Frequency:** See table.

**Maximum Input Power:** For 20° C. rise, 3 watts.

For precise work, 1.5° C. rise, 200 milliwatts. See table for corresponding current limitations.

**Mounting:** Aluminum cabinet with carrying handle and rubber feet, black crackle finish.

**Terminals:** Two insulated jack-top terminals, plus jack-top ground terminal and strap.

**Dimensions:**  $6\frac{1}{2}'' \times 6\frac{1}{2}'' \times 8''$  height over-all.

**Weight:** 11½ pounds.

Type	Nominal Inductance	Nominal Limits %	Limits of Certificate Value %	*Resonant Frequency kc	*D-C Resistance ohms	*K Values	Milliamperes rms for 200mw 3w	Code Word	Price
1482-B	100 $\mu$ h	±0.25	±0.10	3500	0.29	460	830 3200	INDUCTOTAG	\$75.00
1482-C	200 $\mu$ h	±0.25	±0.05	2150	0.39	310	720 2800	INDUCTOTED	75.00
1482-D	500 $\mu$ h	±0.1	±0.05	1180	0.60	190	580 2240	INDUCTOTIM	80.00
1482-E	1 mh	±0.1	±0.05	700	1.06	169	430 1680	INDUCTOTOP	80.00
1482-F	2 mh	±0.1	±0.05	620	2.20	175	300 1160	INDUCTOTUB	80.00
1482-G	5 mh	±0.1	±0.05	370	4.9	156	200 780	INDUCTOVAT	80.00
1482-H	10 mh	±0.1	±0.03	240	8.3	132	155 600	INDUCTOVEX	80.00
1482-J	20 mh	±0.1	±0.03	170	18.5	147	104 400	INDUCTOWAD	80.00
1482-K	50 mh	±0.1	±0.03	92	46	146	66 255	INDUCTOWET	80.00
1482-L	100 mh	±0.1	±0.03	61	92	146	47 180	INDUCTOWIG	85.00
1482-M	200 mh	±0.1	±0.03	38	110	88	43 165	INDUCTOWOW	85.00
1482-N	500 mh	±0.1	±0.03	27	340	108	24 94	INDUCTOYAK	95.00
1482-P	1 h	±0.1	±0.03	15.3	600	95	18 70	INDUCTOYES	100.00
1482-Q	2 h	±0.1	±0.03	10.2	1350	107	12 47	INDUCTOYUG	115.00
1482-R	5 h	±0.1	±0.05	6.2	3500	111	7.5 29	INDUCTOYBIN	145.00
1482-T	10 h	±0.1	±0.05	4.3	8100	129	5.0 19	INDUCTOYBAL	185.00

\* Representative values. Actual values given on certificate.



**USES:** The TYPE 1481 Inductors have higher low-frequency values of storage factor  $Q$  than the TYPE 1482 Standard Inductors. They are useful at audio frequencies as standards of self-inductance, although their accuracy of adjustment is not so high as that of the TYPE 1482 Inductors, and, for some uses, allowance must be made for their voltage coefficient of inductance.

**DESCRIPTION:** These inductors are uniformly wound toroidal units on molybdenum-permalloy dust cores, identical in construction with the toroids used in TYPE 940 Decade Inductor Units. The aluminum case affords an electrostatic shield.



## TYPE 1481 STANDARD INDUCTOR

- FEATURES:**
- High storage factor,  $Q$  — between 230 and 300, maximum.
  - $Q$  is greater than 1 down to 6 cycles.
  - Inherently astatic.
  - Electrostatically shielded.

### SPECIFICATIONS

**Accuracy:** See table below. Accuracy of adjustment is limited to the change produced by a single turn of the winding. Nominal value of inductance, with tolerance limits, and current for 0.25% change in inductance, are engraved on the case. Calibration is at initial permeability.

**Storage Factor,  $Q$ :** Maximum initial  $Q$  is between 230 and 300. The plot of Figure 1 shows the variation of dissipation factor ( $D = \frac{1}{Q}$ ) as a function of frequency for initial permeability, i.e., with no hysteresis loss. Hysteresis loss for an r-m-s current  $I$  in terms of  $I_1$  (see table) will add approximately  $.001 \frac{I}{I_1}$  directly to  $D$ .

**Current Coefficient of Inductance:** Per cent change in inductance as a function of  $\frac{I}{I_1}$  is given in Figure 1, page 166), where  $I$  is the r-m-s operating current and  $I_1$  the

current that would produce a 0.25% linear increase in  $L$ . **Incremental Inductance:** D-C bias will reduce the initial inductance as shown in Figure 1, page 166.

**Frequency Characteristics:** Per cent change in inductance with frequency is plotted in Figure 2, below.

**Temperature Coefficient of Inductance:** Approximately — 0.0025% per degree C, between 16° and 32° C.

**Safe Operating Limits:** (1) Maximum terminal voltage, 500 volts, r-m-s or (2) maximum r-m-s current = 70  $I_1$ , whichever limit is pertinent.

**Distributed Capacitance:** Between 28  $\mu\mu\text{f}$  for the 1-mh unit and 33  $\mu\mu\text{f}$  for the 5-h unit.

**Mounting:** Aluminum case. External finish, black crackle.

**Terminals:** Jack-top binding posts, one grounded to case. A pair of double-ended plugs is furnished, for connection to jack-top binding posts.

**Dimensions:** Case (height)  $3\frac{5}{8}$  x (width)  $3\frac{1}{8}$  x (depth)  $1\frac{5}{8}$  inches; over-all height, including terminals,  $4\frac{5}{8}$  inches. **Net Weight:** 14 ounces.

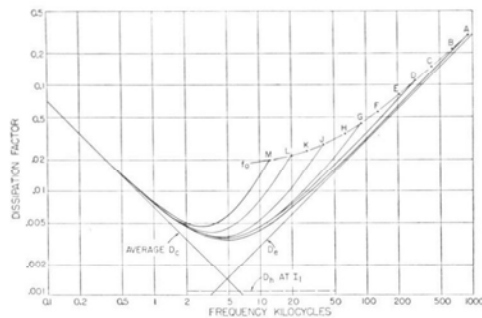

(Left) FIGURE 1. Initial  $D$  versus frequency for typical units ( $D_h = 0$ ).

(Right) FIGURE 2. Percent increase in  $L_0$  with frequency.

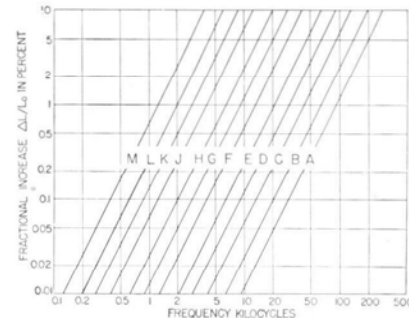

Type Inductor	Nominal Inductance $L$	Accuracy %	R-M-S Current, $I_1$ , for 0.25% increase in $L_0$ ma	Resonant Frequency $f_0$ kc	Approx. D-C Resistance $\Omega$	Code Word	Price
1481-A	1 mh	±1	24	940	0.043	INDUCTOSAP	\$28.00
1481-B	2 mh	±1	17	660	0.15	INDUCTOSET	28.00
1481-C	5 mh	±1	11	420	0.25	INDUCTOSIG	28.00
1481-D	10 mh	±0.5	7.6	300	0.44	INDUCTOSOT	28.00
1481-E	20 mh	±0.5	5.4	210	0.95	INDUCTOSUM	28.00
1481-F	50 mh	±0.5	3.4	130	2.31	INDUCTOPAL	28.00
1481-G	100 mh	±0.25	2.4	91	4.3	INDUCTOPEG	30.00
1481-H	200 mh	±0.25	1.7	64	7.2	INDUCTOPIT	30.00
1481-J	500 mh	±0.25	1.1	40	22	INDUCTOPOD	30.00
1481-K	1 h	±0.25	0.76	28	40	INDUCTOPUB	30.00
1481-L	2 h	±0.25	0.54	20	91	INDUCTORAM	32.00
1481-M	5 h	±0.25	0.34	12.5	230	INDUCTORED	34.00



**USES:** The TYPE 107 Variable Inductors find their greatest uses in the laboratory as adjustable standards of moderate accuracy for measurements of self and mutual inductance, and as circuit elements in bridges, oscillators, and similar equipment.

## TYPE 107 VARIABLE INDUCTOR

**DESCRIPTION:** Two coils, a rotor and a stator, are mounted concentrically. As the position of the rotor is changed the coupling between the two coils changes, and the inductance is varied.

In most models stranded wire is used, in which the separate strands are insulated from one another. The coils are impregnated and baked in a high-melting-point material before being securely mounted to the phenolic panel.

**FEATURES:** ➤ Continuous adjustment of self or mutual inductance. Direct reading in inductance for the series connection of the coils. Inductance for the parallel connection is exactly one-fourth the value shown by the dial. Total inductance range of approximately 25:1.

➤ Rotor and stator may be quickly connected in either series or parallel as a self-inductor, or used separately as a mutual inductor.

➤ Rotor and stator inductances have been equalized so that losses are not appreciably increased by circulating currents when the parallel connection is used.

### SPECIFICATIONS

**Self-Inductance Range:** See table below.

**Mutual Inductance:** See table below. Either positive or negative values of mutual inductance can be obtained. The exact formula for the mutual inductance is engraved on each individual instrument.

**Calibration:** The inductance for the series connection, measured at 1 kc and accurate within  $\pm 1\%$  of full-scale reading, is engraved on the dial. The inductance for the parallel connection is one-fourth of the series inductance within  $\pm 0.1\%$ .

The mutual inductance accuracy is  $\pm 2.5\%$  of the maximum mutual inductance value.

**Frequency Error:** The fractional increase in inductance with frequency will be  $f^2/f_0^2$  where  $f$  is the operating frequency and  $f_0$  the natural frequency. Full-scale values of  $f_0$  are tabulated below. To a first approximation  $f_0$  varies inversely as the square root of the scale setting. The change of dissipation factor  $D = \frac{1}{Q}$  with frequency for full-scale setting, series connection, is shown in the plot below.

**Maximum Power and Current:** Current for 15 watts maximum dissipation, corresponding to a 40° C temperature rise, is given in the table below and is engraved on the nameplate.

**D-C Resistance:** See table below. These series connection values are engraved on the nameplate. For parallel connections the resistance is closely  $\frac{1}{4}$  the tabulated values.

**Terminals:** Standard  $\frac{3}{4}$ -inch spacing, jack-top binding posts are provided which allow separate connections to rotor and stator. Connecting links are supplied so that either a series or parallel connection of the rotor and stator can be made available at a third pair of binding posts.

**Mounting:** All units are mounted on phenolic panels and enclosed in non-shielded walnut cabinets.

**Dimensions:**  $6\frac{1}{2} \times 6\frac{1}{2} \times 8\frac{3}{4}$  inches high, over-all.

**Net Weight:** 5 pounds, all ranges.

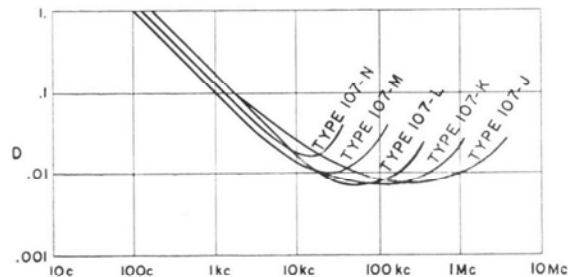

Dissipation factor ( $D = 1/Q$ ) versus frequency for TYPE 107 Variable Inductors for the full-scale series connection.

Type	Self-Inductance		Mutual Inductance	Natural Frequency (kc)*		D-C Resistance $\Omega$	Maximum Current <i>a</i>	Code Word	Price
	Series	Parallel		Series	Parallel				
107-J	9- 50 $\mu$ h	2.25-12.5 $\mu$ h	0-10.8 $\mu$ h	3700	6500	0.05	16.	HAREM	\$80.00
107-K	90-500 $\mu$ h	22.5-125 $\mu$ h	0-110 $\mu$ h	1100	1900	0.38	6.	HARPY	80.00
107-L	0.9- 5 mh	0.225-1.25 mh	0-1.1 mh	360	620	4.6	1.7	HARRY	85.00
107-M	9- 50 mh	2.25-12.5 mh	0-11 mh	120	210	32	0.65	HOTEL	90.00
107-N	90-500 mh	22.5-125 mh	0-110 mh	35	60	410	0.18	HOVER	90.00

\* For full-scale setting.





**USES:** These boxes are particularly useful in circuit development and experimental filters, equalizers, and other networks.

**DESCRIPTION:** The TYPE 1490 Decade Inductor is an assembly of three or four TYPE 940 Decade-Inductor Units in a single metal cabinet. The units have no electrical connection to the panel, but a separate ground terminal is provided which can be connected to the adjacent "low" terminal, which leads to the smallest decade.

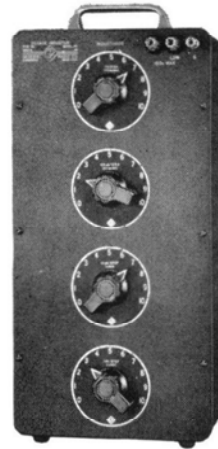

## TYPE 1490 DECADE INDUCTOR

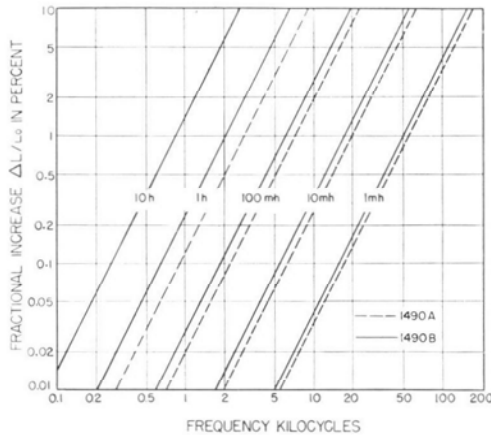

Percent increase in  $L_0$  with frequency.

### SPECIFICATIONS

**Frequency Characteristics:** By vertical interpolation in the accompanying plot the percentage increase in effective series inductance (above the geometric value when  $f = 0$ ) may be obtained for any setting of the non-ground inductors.

**Terminals:** Jack-top binding posts.

**Mounting:** The decades are mounted on an aluminum panel in a metal cabinet.

**Dimensions:** 1490-A  $12\frac{3}{4} \times 7\frac{3}{4} \times 5\frac{1}{2}$  inches over-all height. 1490-B  $16\frac{1}{2} \times 7\frac{3}{4} \times 5\frac{1}{2}$  inches over-all height.

**Net Weight:** TYPE 1490-A,  $15\frac{1}{2}$  pounds; TYPE 1490-B,  $19\frac{1}{4}$  pounds.

Other specifications are identical with those for the TYPE 940 Decade-Inductor Units.

Type	Inductance	Code Word	Price
1490-A	1.11 h, total, in steps of 0.001 h.....	CLUMP	\$280.00
1490-B	11.11 h, total, in steps of 0.001 h.....	COACH	375.00

NOTE: The TYPE 1432 Decade Resistor and the TYPE 219 Decade Capacitor can be found on pages 169 and 160 respectively.

## TYPE 940 DECADE-INDUCTOR UNIT

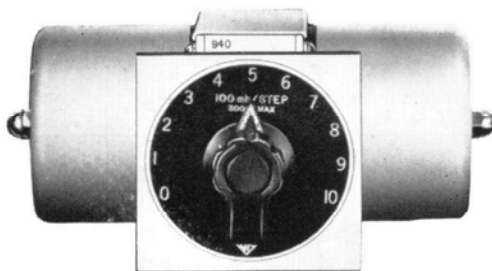

**USES:** The TYPE 940 Decade-Inductor Units are convenient elements for use in wave filters, equalizers, and tuned circuits throughout the range of audio and low-radio frequencies. As components in oscillators, analyzers, and similar equipment, they are especially useful during the preliminary design period when the ability to vary circuit elements over relatively wide ranges is necessary to determine optimum

operating values. As moderately precise standards of inductance they have values of low-frequency storage factor,  $Q$ , which are much larger than can be obtained with air-cored coils.

**DESCRIPTION:** Each unit is an assembly of four toroids wound on molybdenum-permalloy dust cores. All four coils (relative values 1, 2, 2, 5) are connected in series, and the switch short-circuits combinations of the coils to give the eleven successive values from 0 to 10. The switch blades are beryllium copper with palladium-alloy stud contacts to decrease both contact and volume resistance.

**FEATURES:** ➤ High values of storage factor  $Q$  are obtained in all models, with maximum values above 200.

➤ Toroidal construction practically eliminates



any external magnetic field, and makes it possible to stack the coils closely without errors from mutual inductance. The toroids are nearly astatic to external magnetic fields.

- Electrostatic shielding and mechanical protection are furnished by the aluminum frame and covers.
- Moisture is kept from the windings by wax impregnation.

**SPECIFICATIONS**

**Accuracy:** Each unit is adjusted so that its inductance at zero frequency and initial permeability will be the nominal value within the accuracy tolerance given in the following table:

Inductance per step	1 mh	10 mh	100 mh	1 h
Accuracy	±2%	±1%	±0.5%	±0.25%

**Frequency Characteristics:** For any specific operating frequency, Figure 2 shows the percentage increase in effective series inductance (above the geometric value when  $f = 0$ ) which is encountered with the extreme settings of each of the four Decade Inductor Units when the chassis is floating. Vertical interpolation may be used for intermediate settings.

**FIGURE 1.** Percent change in normal and incremental inductance with a-c and bias current. Incremental curve is limited to an a-c excitation less than  $I_1$ .

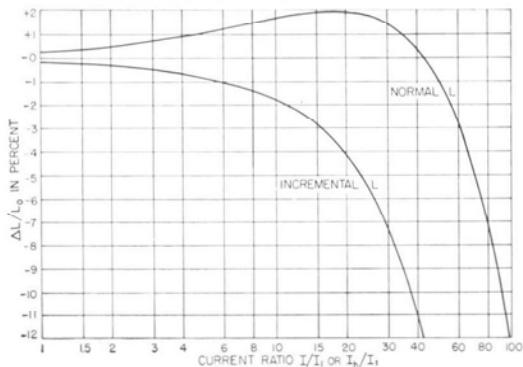

**Change in Inductance with Current:** Fractional change in initial inductance with a-c current for each size of toroid is shown in the normal curve, Figure 1, in terms of the ratio of the operating current  $I$ , to  $I_1$ , the current for 0.25% change. For ratios below unity, inductance change is directly proportional to current. Values of  $I_1$  listed below are approximate and are based on the largest inductor in circuit for each setting.

Switch Setting	RMS $I_1$ (ma) for 0.25% Increase			
	940-A	940-B	940-C	940-D
1	24	7.6	2.4	0.76
2, 3, 4	17	5.4	1.7	0.54
5, 6, 7, 8, 9, 10	11	3.4	1.1	0.34

**Incremental Inductance:** D-C bias current  $I_b$  will reduce the initial inductance as shown in the incremental curve, Figure 1.

**Dissipation Factor:** See Figure 3.

**D-C Resistance:** 60 ohms/henry for TYPE 940-A, 45 ohms/henry for TYPES 940-B, C, D.

Type	Inductance	Code Word	Price
940-A	0.01 h in 0.001 h steps.....	INDUCTOANT	\$85.00
940-B	0.1 h in 0.01 h steps.....	INDUCTOBOY	80.00
940-C	1 h in 0.1 h steps.....	INDUCTOCAT	86.00
940-D	10 h in 1 h steps.....	INDUCTODOG	94.00

NOTE: decade-resistor units and decade-capacitor units are listed on pages 170 and 158 respectively.

**FIGURE 2.** Percent increase in  $L_0$  with frequency.

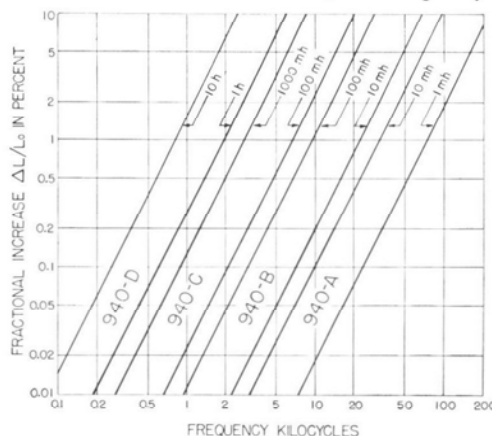

**Temperature Coefficient:** Approximately  $-0.0025\%$  per degree C between 16 and 32° C.

**Maximum Voltage:** 500 volts rms. The switch will break the circuit at 500 volts if turned rapidly to the new setting, but voltages above 150 may cause destructive arcing if the switch is set between detent positions.

**Maximum Current:** 70 times the pertinent  $I_1$  value.

**Terminals:** Soldering lugs are provided. Circuit insulated from chassis.

**Mounting:** Each decade is complete with dial plate, knob, and mounting screws.

**Dimensions:** (Width)  $7\frac{1}{4}$  x (height)  $3\frac{1}{2}$  x (depth behind panel)  $3\frac{1}{4}$  inches, over-all.

**Net Weight:**  $3\frac{1}{2}$  pounds.

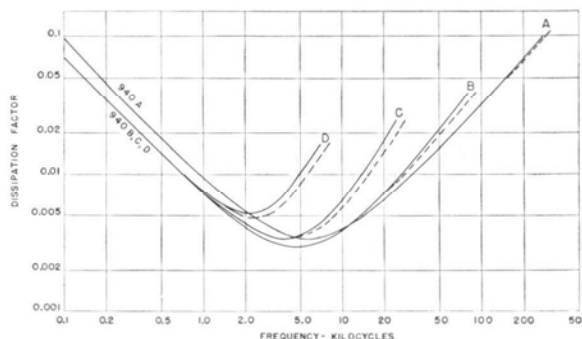

**FIGURE 3.** Variation of dissipation factor for the full value of each inductor. Dashed curves correspond to use with chassis floating.

# RESISTORS

Because of accuracy of adjustment, long-time stability, low and uniform temperature coefficient, and relative immunity to ambient humidity conditions, the wire-wound resistor is the most suitable type for use as a laboratory standard at audio and low-radio frequencies, as well as at dc. In the resistance range from a fraction of an ohm to about one megohm such resistors have been developed to a high state of refinement through improvements in resistive alloys and in design and manufacturing techniques. The wire-wound resistors in the form of fixed elements, individual decades, and decade assemblies ("decade boxes") described on the following pages are designed for a-c use as well as for d-c.

Resistors designed for a-c use differ from those intended for use only at direct current in that low series reactance and constancy of resistance as frequency is varied are important design objectives. Inevitably, resistors have capacitance and inductance associated with them, and these residual reactances become increasingly important as the frequency is raised, acting to change the terminal resistance from its low-frequency value.

For frequencies where the resistance and its associated residual reactances behave as lumped parameters, the equivalent circuit of a resistor can be represented as shown in Figure 1. The inductance  $L$  is the equivalent inductance in series with the resistance, while the capacitance  $C$  is the equivalent capacitance across the terminals of the resistor.

To analyze the behavior of the equivalent circuit as frequency is varied, it is necessary to differentiate clearly between the concepts of equivalent series and equivalent parallel circuits. The two-terminal circuit of Figure 1 can be described as an impedance,  $R_s + jX_s$ ,

or as an admittance,  $G + jB \left( = \frac{1}{R_p} + \frac{1}{jX_p} \right)$ ,

wherein the parameters are a function of frequency. This distinction between series and parallel components is more than a mathematical exercise — the use to which the resistor is put will frequently determine which component is of principal interest.

The expressions for the effective series resistance ( $R_s$ ) and the effective series reactance ( $X_s$ ) of Figure 1 are:

$$R_s = \frac{R}{\left[ 1 - \left( \frac{\omega}{\omega_0} \right)^2 \right]^2 + (R\omega C)^2} \quad (1)$$

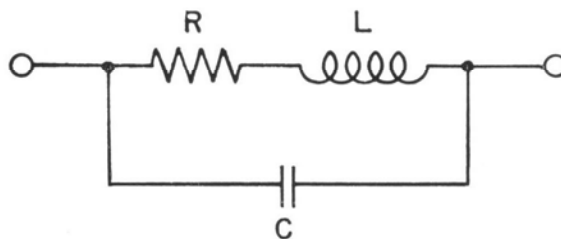

FIGURE 1. Equivalent circuit of a resistor showing the residual impedances associated with the resistance.

$$X_s = \frac{\omega \left\{ L \left[ 1 - \left( \frac{\omega}{\omega_0} \right)^2 \right] - R^2 C \right\}}{\left[ 1 - \left( \frac{\omega}{\omega_0} \right)^2 \right]^2 + (R\omega C)^2} \quad (2)$$

where

$$\omega_0 = \frac{1}{\sqrt{LC}} \quad \text{and} \quad \left( \frac{\omega}{\omega_0} \right)^2 = \omega^2 LC \quad (3)$$

The effective parallel components are given by:

$$G = \frac{1}{R_p} = \frac{1}{R \left[ 1 + \omega^2 \left( \frac{L}{R} \right)^2 \right]} \quad (4)$$

$$B = -\frac{1}{X_p} = \omega C - \frac{1}{\omega L \left[ 1 + \omega^2 \left( \frac{R}{L} \right)^2 \right]} \quad (5)$$

At frequencies sufficiently low that terms involving the square of frequency are negligible, the resistor may be represented by a two-element network consisting of the d-c resistance,  $R$ , in series with an inductance equal to  $L - R^2 C$  or in parallel with a capacitance

equal to  $C - \frac{L}{R^2}$ . Because of the presence of the

$R^2$  term in the equivalent reactive parameters, shunt capacitance is the dominating residual for high values of resistance, while for low values of resistance the series inductance invariably predominates. It is, in fact, a common fallacy to speak of "non-inductive" resistors in resistance values where shunt capacitance controls, and variations in inductance of the winding can have no significant effect on the reactive component.

In the simplified circuit described above, the effective parallel resistance of a resistor in which shunt capacitance dominates would be independent of frequency. Actually, other effects may cause the parallel resistance to decrease with frequency. For example, dielec-

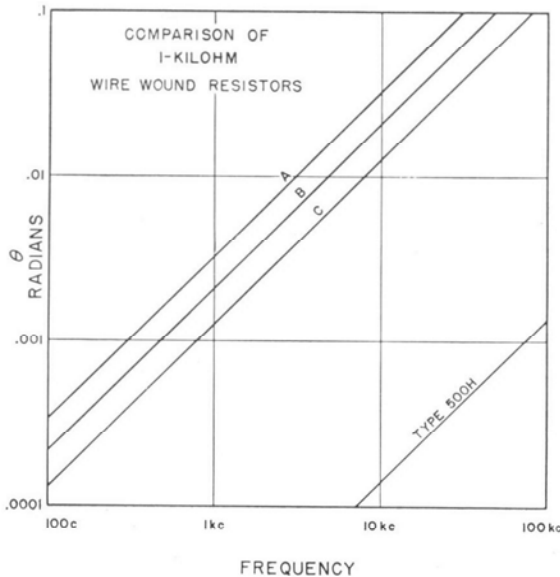

FIGURE 2. Phase angle as a function of frequency for a General Radio mica-card resistor and for three commercial wire-wound types.

tric losses in the shunt capacitance,  $C$ , of Figure 1 are equivalent to a resistance

$$R_o = \frac{1}{D\omega C}$$

which decreases with increasing frequency and causes even the parallel resistance to decrease rapidly beyond a certain frequency. That portion of the shunt capacitance,  $C$ , which is distributed causes a similar rapid decrease in resistance, even if its dielectric loss is negligible.

General Radio wire-wound resistance elements are designed to minimize inductance in low-resistance values and to minimize capacitance for high values of resistance. All units up through 100 ohms utilize a so-called Ayrton-Perry winding, in which each resistor consists of two parallel windings of opposed direction, so that the current flow in the two windings is in opposite directions. The external magnetic field, as a result, is effectively canceled so that, typically, the residual inductance of such a winding is of the order of 1% of the inductance of a corresponding single winding.

Elements having 200 ohms resistance or higher are unifilar-wound on their flat rectangular "cards". The inherent phase angle of these resistors is substantially lower than that obtained with so-called "non-inductive" spool-wound resistors commonly used commercially.

Wire-wound resistors of these types exhibit a negligible frequency error in resistance up to about 500 kc, for values of resistance up to 500 ohms, and only moderate errors at one megacycle.

When assembled into decades, these resistors have added to their own residual impedances those of the switches, wiring, and cabinet. The equivalent circuit is then that of Figure 3, which represents a single decade of the 510 type. For assemblies of such decades in the TYPE 1432 Decade Resistor the same circuit is still valid. The incremental inductances of the several decades in the circuit are additive, but the capacitance is approximately that of highest decade in use. Typical values of the residual impedances for the various types of General Radio resistors are given in the specifications for each type.

It should be noted that the effect of the residual reactance depends greatly upon the way the resistor is connected into a circuit. Reactances can often be tuned out, particularly in parallel circuits. This is a particularly important consideration with the higher-valued resistors of 10,000 ohms and above. When the resistor is used as a parallel circuit element, the upper limit of frequency for a given error is some 10 times higher than for the series connection.

Probably the best known resistance alloy is manganin, used for over half a century in the manufacture of precision resistors. This old established alloy is still the most suitable for low values of resistance. For higher values, where small-diameter wire is required, more modern, proprietary alloys have been demonstrated to be superior. Such alloys are characterized by low, positive temperature coefficients, substantially constant over a wide range of temperature. They have, in addition, negligible thermal emf against copper, high tensile strength, relative immunity to the effects of humidity and atmosphere, and are relatively insensitive to strain. These newer alloys are used in all GR precision resistors of 40 ohms and above.

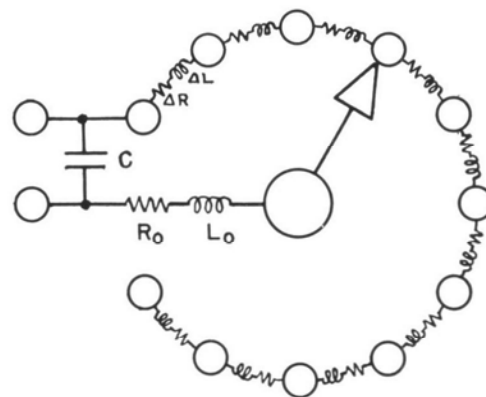

FIGURE 3. Equivalent circuit of a resistance decade, showing location and nature of residual impedances.



## TYPE 1432 DECADE RESISTOR

**USES:** Accurate decade resistors are necessary wherever electrical measurements are made. They are used in circuits where a wide range of resistance values is required or where variable dummy generator and load resistances are needed. The accuracy of TYPE 1432 Decade Resistors easily meets the requirements of these applications and also permits them to be used as laboratory standards and as ratio arms for direct- and alternating-current bridges.

Although designed primarily for direct-current and audio-frequency work, many of the models are useful well into the radio-frequency range.

General Radio decade resistors are the standard of the industry. They have been manufactured continuously since 1915 and have been constantly improved in accuracy, stability, and appearance through the use of the finest available materials and manufacturing techniques.

**DESCRIPTION:** The TYPE 1432 Decade Resistor is an assembly of TYPE 510 Decade-Resistance Units in a single cabinet. Mechanical as well as electrical shielding of the units is provided by the attractive aluminum cabinet and panel, which completely enclose both the resistance units and switch contacts. The resistance elements have no electrical connection to the cabinet and panel, for which a separate shield terminal is provided.

Three-, four-, and five-dial decade assemblies are available. Each decade has eleven contact studs and ten resistance units, so that the dial values overlap. Positive detent



mechanisms in conjunction with bar-type knobs permit the operator to sense the position of the switches without looking at the panel.

**FEATURES:** ➤ Low zero resistance — less than 0.003 ohm per decade.

➤ High accuracy — 0.05% for most decades.

➤ Low temperature coefficient of resistance.

➤ Negligible thermal emf to copper.

➤ Resistors are adjusted to specified values at their own terminals rather than at the box terminals, so that resistance *increments* are always correctly indicated.

➤ Residual reactances are small and are given in the specifications so that approximate frequency characteristics can be computed.

### SPECIFICATIONS

**Frequency Characteristics:** Similar to those of individual TYPE 510 Decade Resistance Units, modified by the increased series inductance,  $L_0$ , and shunt capacitance,  $C$ , due to the wiring and the presence of more than one decade in the assembly. At total resistance settings of approximately 1000 ohms or less, the frequency characteristic of any of these decade resistors is substantially the same as those shown for the TYPE 510 Decade-Resistance Units in the plot on page 171. At higher settings, shunt capacitance becomes the controlling factor, and the effective value of this capacitance depends upon the settings of the individual decades. See *Residual Impedances* below, and Figure 3, page 168.

**Residual Impedances:**

Zero Resistance ( $R_0$ ): 0.002 to 0.003 ohms per dial at dc; 0.04 ohms per dial at 1 Mc; proportional to square root of frequency at all frequencies above 100 kc.

Zero Inductance ( $L_0$ ): 0.10  $\mu$ h per dial.

Effective Shunt Capacitance ( $C$ ): This value is determined largely by the highest decade in use. With the LOW terminal connected to shield, a value of 15 to 10  $\mu$ f per decade may be assumed, counting decades down

from the highest. Thus, if the third decade from the top is the highest resistance decade in circuit (i.e., not set at zero) the shunting terminal capacitance is 45 to 30  $\mu$ f. If the highest decade in the assembly is in use, the effective capacitance is 15 to 10  $\mu$ f, regardless of the settings of the lower-resistance decades.

**Temperature Coefficient of Resistance:** Less than  $\pm 0.002\%$  per degree Centigrade at room temperatures, except for the 0.1  $\Omega$  decade, where the box wiring will increase the over-all temperature coefficient.

**Type of Winding:** See specifications for TYPE 510 Decade-Resistance Units, page 171.

**Accuracy of Adjustment:** All cards are adjusted at dc within  $\pm 0.05\%$  of the stated value at their terminals, except the 1-ohm units, which are adjusted within  $\pm 0.15\%$ , and the 0.1-ohm units, which are adjusted within  $\pm 0.5\%$ .

**Maximum Current:** See specifications for TYPE 510 Decade-Resistance Units, page 171. Values for 40° C rise are engraved on panels directly above switch knobs.

**Terminals:** Jack-top binding posts set on General Radio standard  $\frac{3}{4}$ -inch spacing. Shield terminal is provided.

**Mounting:** Aluminum panel and cabinet.



**Dimensions:** Width,  $4\frac{5}{16}$  inches; height,  $4\frac{11}{16}$  inches; length,  $10\frac{3}{16}$  inches for 3-dial, 13 inches for 4-dial, and  $15\frac{3}{4}$  inches for 5-dial box.

**Net Weight:** TYPE 1432 — A, C, F, 4 pounds, 2 ounces; TYPE 1432 — J, K, L, Q, 5 pounds, 4 ounces; TYPE 1432 — M, N, P, 6 pounds, 5 ounces.

Type	Resistance	No. of Dials	Type 510 Decades Used	Code Word	Price
1432-F	111 ohms, total, in steps of 0.1 ohm	3	A, B, C	DELTA	\$66.00
1432-K	1,111 ohms, total, in steps of 0.1 ohm	4	A, B, C, D	DEFER	88.00
1432-C	11,100 ohms, total, in steps of 10 ohms	3	C, D, E	DEBAR	74.00
1432-J	11,110 ohms, total, in steps of 1 ohm	4	B, C, D, E	DEBIT	95.00
1432-N	11,111 ohms, total, in steps of 0.1 ohm	5	A, B, C, D, E	DEMON	111.00
1432-L	111,100 ohms, total, in steps of 10 ohms	4	C, D, E, F	DECAY	100.00
1432-M	111,110 ohms, total, in steps of 1 ohm	5	B, C, D, E, F	DEMIT	121.00
1432-A	1,110,000 ohms, total, in steps of 1000 ohms	3	E, F, G	DEMUR	94.00
1432-Q	1,111,000 ohms, total, in steps of 100 ohms	4	D, E, F, G	DEPOT	116.00
1432-P	1,111,100 ohms, total, in steps of 10 ohms	5	C, D, E, F, G	DETER	137.00

## TYPE 510 DECADE-RESISTANCE UNIT

**USES:** Because of their accuracy, compactness, and sturdy construction the TYPE 510 Decade-Resistance Units are ideal for assembly into production test instruments, bridges, and other experimental and permanent equipment. They are particularly useful in applications where only one or two decades are needed, or where a TYPE 1432 Decade Resistor cannot be mounted conveniently. In many cases the use of these units will release for general laboratory work relatively more expensive decade resistors, that would otherwise be tied up for long periods of time in experimental equipment.

**DESCRIPTION:** Winding methods are chosen to reduce the effects of residual reactances. The 1- and 10-ohm steps are Ayrton-Perry wound on molded phenolic forms especially shaped and heat treated to minimize aging effects. The 100-ohm steps are Ayrton-Perry wound on a form of silicone-fiberglass laminate. The 0.01- and 0.1-ohm steps are hairpin-shaped ribbon, while the 1000-, 10,000-, and 100,000-ohm steps are unifilar wound on thin mica cards.

Each decade is enclosed in an aluminum shield, and a knob and etched-metal dial plate are supplied. The mechanical assembly is also available complete with shield, blank dial plate, switch stops, and knob, but without resistors, as the TYPE 510-P3 and -P3L Switches.

**FEATURES:** ➤ High accuracy —  $\pm 0.05\%$  for most units.

➤ Excellent stability — newly developed stable resistance alloys, with final resistance adjustment after artificial aging at high temperatures above normal operating temperatures.

➤ Good frequency characteristics — most TYPE 510 Decades can be used at frequencies as high as several hundred kilocycles, as well as at dc.

➤ Low temperature coefficient.

➤ Negligible thermal emf to copper.

➤ Unaffected by high humidity — even the high resistance units can be exposed to high humidity for long periods of time without significant permanent change in resistance.

*Note:* For decade capacitors, see pages 157-160. For decade inductors, see pages 165, 166.



## SPECIFICATIONS

**Accuracy of Adjustment:** Resistors are adjusted to be accurate at card terminals within the tolerances given in Table I.

**Maximum Current:** See Table I below. Maximum current is engraved on the dial plate supplied with each

decade.

**Frequency Characteristics:** The equivalent circuit of a decade resistance unit is shown on page 168. The values of the residual impedances are listed in Table I.

The accompanying plot shows the maximum per-



centage change in effective series resistance of seven decades as a function of frequency. For TYPES 510-A and 510-B the error is due almost entirely to skin effect and is independent of switch setting. For TYPE 510-C the error changes slowly with dial setting and is a maximum at maximum resistance setting, while for TYPE 510-D a broad maximum occurs at the 600-ohm setting. For all the higher resistance units, the error is due almost entirely to the shunt capacitance and its losses and is approximately proportional to the square of the resistance setting.

The high-resistance decades (TYPES 510-E, 510-F, and 510-G) are very commonly used as parallel resistance elements in resonant circuits, in which the shunt capacitance of the decades becomes part of the tuning capacitance. The parallel resistance changes by only a fraction, between a tenth and a hundredth, of the amount indicated in the plot as the series-resistance change, depending on frequency and the insulating material in the switch.

**Switches:** Quadruple-leaf, phosphor-bronze brushes bear on lubricated bronze contact studs  $\frac{3}{8}$  inch in diameter.

These brushes are bent so as not to be tangent to the arc of travel, thus avoiding cutting and affording a good wiping action. A cam-type detent is provided. There are eleven contact points (0 to 10 inclusive). The switch resistance is between 0.002 and 0.003 ohm. The effective capacitance of the switch is of the order of  $5 \mu\mu\text{f}$ , with a dissipation factor of 0.06 at 1 kc for the standard cellulose-filled molded phenolic switch form, and 0.01 for the mica-filled phenolic form used in the TYPE 510-G Unit.

**Temperature Coefficient of Resistance:** Less than  $\pm 0.002\%$  per degree Centigrade at  $23^\circ \text{C}$ .

**Terminals:** Soldering lugs are provided.

**Mounting:** Each decade is complete with dial plate and knob and can be mounted on any panel between  $\frac{1}{4}$  inch and  $\frac{3}{8}$  inch in thickness. A template is furnished with each unit.

**Dimensions:** Over-all diameter,  $3\frac{1}{16}$  inches; depth behind panel,  $3\frac{3}{16}$  inches; template and dimension sketch mailed on request.

**Net Weight:** TYPE 510 Units, 11 ounces; TYPE 510-P3,  $9\frac{1}{2}$  ounces.

TABLE I

Type	Resistance per Step ( $\Delta R$ ) Ohms	Accuracy	Maximum Current $40^\circ \text{C}$ Rise	Power per Step watts	$\Delta L$ $\mu\text{h}$	$C^*$ $\mu\mu\text{f}$	$L_0$ $\mu\text{h}$
510-AA	0.01	$\pm 2\%$	4 a	.16	0.01	7.7-4.5	0.023
510-A	0.1	$\pm 0.5\%$	1.6 a	.25	0.014	7.7-4.5	0.023
510-B	1	$\pm 0.15\%$	800 ma	.6	0.056	7.7-4.5	0.023
510-C	10	$\pm 0.05\%$	250 ma	.6	0.11	7.7-4.5	0.023
510-D	100	$\pm 0.05\%$	80 ma	.6	0.29	7.7-4.5	0.023
510-E	1,000	$\pm 0.05\%$	23 ma	.5	3.3	7.7-4.5	0.023
510-F	10,000	$\pm 0.05\%$	7 ma	.5	9.5	7.7-4.5	0.023
510-G	100,000	$\pm 0.05\%$	2.3 ma	.5	—	7.7-4.5	0.023

\* The larger capacitance occurs at the lowest setting of the decade. The values given are for units without the shield cans in place. With the shield cans in place, the shunt capacitance is from 10 to  $20 \mu\mu\text{f}$  greater than indicated here, depending on whether the shield is tied to the switch or to the zero end of the decade.

Resistance

Type	Total	Per Step	Code Word	Price
510-AA	0.1 ohm	0.01 ohm	EASEL	\$17.50
510-A	1 ohm	0.1 ohm	ELATE	14.00
510-B	10 ohms	1 ohm	ELDER	19.00
510-C	100 ohms	10 ohms	ELEGY	19.00
510-D	1,000 ohms	100 ohms	ELBOW	20.00
510-E	10,000 ohms	1,000 ohms	ELECT	21.00
510-F	100,000 ohms	10,000 ohms	ELVAN	24.00
510-G	1,000,000 ohms	100,000 ohms	ENTER	35.00
510-R	100,000 ohms	Decade Steps, i.e., 0.1, 1, 10, 100, 1,000, 10,000, 100,000 ohms	EAGER	22.50
510-P3	Switch only (Black Phenolic Frame)		ENVOY	8.50
510-P3L	Switch only (Low-Loss Phenolic Frame)		ESTOP	9.50

Maximum percentage change in series resistance as a function of frequency for TYPE 510 Decade-Resistance Units.

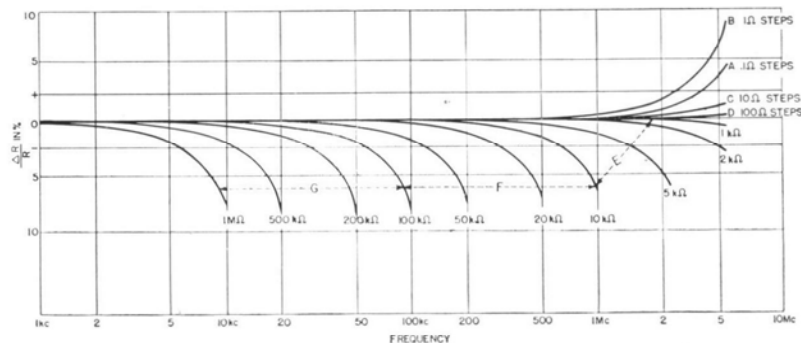



## TYPE 670-F COMPENSATED DECADE RESISTOR



**USES:** The TYPE 670-F Compensated Decade Resistor is a constant-inductance decade resistor for use in a-c measurements where non-reactive increments of resistance are desired. Inductance compensated decade resistors are useful in tuned-circuit substitution measurements, as variable resistance elements in antenna measuring circuits, and, in general, for any use where constancy of inductance is desired as resistance is varied.

**DESCRIPTION:** Each decade is made with a double set of switch contacts, by means of which a copper winding is exchanged, step by step, for the resistance units, thus keeping the total inductance constant regardless of resistance setting. This arrangement is shown in the diagram below.

**FEATURES:** ➤ Inductance remains constant within 0.1 microhenry regardless of resistance setting.

➤ Total inductance is about one microhenry and can usually be balanced out in preliminary adjustment.

### SPECIFICATIONS

**Type of Winding:** The 10-ohm and 1-ohm steps are Ayrton-Perry resistance cards, while the 0.1-ohm steps are bifilar ribbon units.

**Accuracy of Adjustment:** Resistance increments are correct within  $\pm 0.1\%$  for the 10-ohm steps,  $\pm 0.25\%$  for the 1-ohm steps, and  $\pm 1\%$  for the 0.1-ohm steps.

**Zero Resistance:** D-C, about 0.04 ohm; at 1 Mc, about 0.3 ohm; above 100 kc, proportional to square root of frequency.

**Inductance:** Typically 1.05 microhenry, within 0.1 microhenry regardless of resistance setting.

**Switches:** Double-leaf, phosphor-bronze brushes bear on lubricated bronze contact studs  $\frac{1}{4}$  inch in diameter. These brushes are bent so as not to be tangent to the arc of travel, thus avoiding cutting and affording a good wiping action. A cam-type detent is provided, and there are eleven contact points (0 to 10 inclusive).

**Terminals:** Standard  $\frac{3}{4}$ -inch spacing is used on the terminals. A ground post connected to shield and panel is also provided.

**Frequency Characteristics:** Similar to those of TYPE 1432 Decade Resistor, page 169. Change in resistance with frequency results almost entirely from skin effect.

Although skin effect produces a positive change in resistance, the skin effect in the compensating winding is greater than that in the resistance units. Accordingly there is a net negative change in resistance increments

from this effect. That is, the increment in resistance between one switch point and the next higher one will be less at high frequencies than at low. This "negative skin effect," at one megacycle, is about  $-0.8\%$  for the units decade and about  $-0.6\%$  for the tens decade.

**Maximum Current:**

Decade	Current in ma for 40° C Rise
0.1-ohm-per-step	1600
1-ohm-per-step	800
10-ohms-per-step	250

**Mounting:** The decade units are mounted on aluminum panels in copper-lined walnut cabinets.

**Dimensions:** Panel, (length) 13 x (width) 5 inches. Cabinet, (height) 5 inches, over-all.

**Net Weight:**  $5\frac{1}{2}$  pounds.

In the compensated decade resistor opposite ends of the switch blade make contact with resistance or inductance windings, respectively. As a resistance step is added to the circuit, a compensating inductance step is removed, and vice versa.

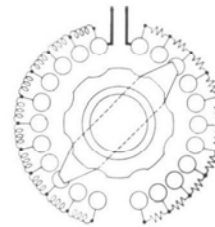

Type	Resistance	Code Word	Price
670-F	0 to 111 ohms, total, in steps of 0.1 ohm...	ABYSS	\$90.00



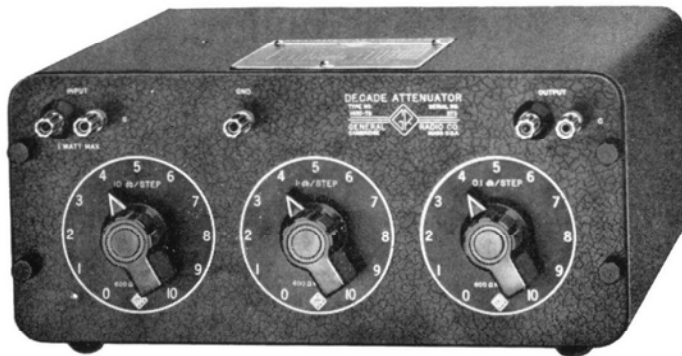

## TYPE 1450

## DECADE ATTENUATOR

**USES:** The TYPE 1450 Decade Attenuator is useful in power-level measurements, transmission-efficiency tests, and in gain or loss measurements on transformers, filters, amplifiers and similar equipment. It can also be used as a power-level control in circuits not equipped with other volume controls.

**DESCRIPTION:** The resistors used in each decade are mounted in compartments in a cast aluminum housing, which is completely shielded by the addition of aluminum covers. Each decade consists of four T-pads series-connected by cam-operated switches, arranged with positive detents. All cams are mounted on a control shaft which is provided with ball bearings. Each pad is completely shielded, and a shield is interposed between the input and output elements of each pad. Each decade has eleven positions, 0 to 10 inclusive, so the decades overlap.

The assembly of decades is mounted in a cast aluminum cabinet.

**FEATURES:** ➤ A wide range of attenuation values is possible in small steps.

➤ The accuracy of the boxes is maintained even at low radio frequencies.

➤ Decade-type switches make the boxes convenient to use. There are no stops on the 0.1- and 1-db-per-step decades, facilitating quick return from full to zero attenuation when making adjustments. Switches are arranged for break-before-make operation to prevent "blasting" and meter damage. They can be adjusted for make-before-break operation if requested at time of ordering.

➤ An etched plate is attached to the case, indicating mismatch loss for terminations other than 600 ohms.

## SPECIFICATIONS

**Attenuation Range:** 110 or 111 decibels in steps of 1 or 0.1 decibel, respectively.

**Terminal Impedance:** 600 ohms in either direction. An etched plate on the cabinet indicates the mismatch loss for other than 600-ohm circuits.

**Accuracy:** Each individual resistor is adjusted within  $\pm 0.25\%$  of its correct value. The low-frequency error in attenuation is less than plus 0.004 db (TA), or 0.006 db (TB)  $\pm 0.25\%$  of the indicated db value, provided the attenuator is terminated by a pure resistance of 600 ohms. When properly terminated, the input impedance is  $600 \pm 3$  ohms.

**Frequency Discrimination:** Less than 0.1 db  $\pm 1\%$  of the indicated value at frequencies below 200 kc.

**Maximum Input Power:** 1 watt.

**Switches:** Cam-type switches are used with twelve positions covering  $360^\circ$ . The dials are numbered from "0" to "10" inclusive and the twelfth point is also connected to "0". Stops are provided in the switch mechanism for

the 100-db decade. No stops are provided to prevent complete rotation of the 10- and 1-db decades, but spacers, which are provided, can be used under the mounting screws to act as stops for the knob.

**Characteristic Impedance:** 600 ohms both directions. Either end can be used as input.

**Mounting:** The decade units are mounted on an aluminum panel in a metal cabinet. Each decade is individually shielded, and all shields are connected to the panel and the "G" terminal. Relay-rack mounting is available on special order at an additional charge. See price list below.

**Terminals:** Jack-top binding posts with  $\frac{3}{4}$ -inch spacing; common terminal of T units grounded to chassis; ground terminal provided.

**Dimensions:** 1450-TA,  $10 \times 5\frac{3}{4} \times 12\frac{1}{4}$  inches, over-all; 1450-TB,  $12 \times 5\frac{3}{4} \times 12\frac{1}{4}$  inches, over-all.

**Net Weight:** 1450-TA,  $10\frac{3}{4}$  pounds; 1450-TB,  $14\frac{1}{2}$  pounds.

Type	Range	Impedance	Type of Section	Code Word	Price
1450-TA	110 db in steps of 1 db.....	600 ohms	T	NETWORKTAM	\$225.00
1450-TB	111 db in steps of 0.1 db.....	600 ohms	T	NETWORKTUB	320.00

For relay rack mounting (19-inch) add \$10.00 to above prices and add R to type number (TYPE 1450-TAR, for example).



## TYPE 1454-A DECADE VOLTAGE DIVIDER



**USES:** The TYPE 1454-A Decade Voltage Divider provides accurately known voltage ratios for use in determining voltage transmission ratios by direct comparison or by null methods. It is particularly valuable in linearity measurements and meter calibration.

Its high input impedance, high resolution, and high accuracy make it a widely used laboratory accessory for both d-c and audio-frequency measurements.

**DESCRIPTION:** The decade voltage division is

accomplished by the use of the Kelvin-Varley circuit. Four resistor decades are connected in such a manner that their settings are additive, while maintaining a constant input resistance.

**FEATURES:** ➤ High accuracy.

➤ Constant input resistance.

➤ Separate ground terminal provided.

➤ Voltage ratios between 1.0000 and .0001 in steps of .0001.

➤ Negligible thermal emf.

### SPECIFICATIONS

**Voltage Ratio:** .0001 to 1.0000 in steps of .0001.

**Accuracy:**  $\pm(0.1\% + .000001)$ . All resistors are adjusted to within  $\pm 0.05\%$  of nominal values. The voltage ratio error will rarely exceed 0.05%, although at low settings of each decade, the error can theoretically approach  $\pm 0.1\%$ .

**Frequency Characteristics:** If the external capacitance placed across the output terminals is less than  $50 \mu\text{mf}$ , the frequency error is less than 0.1% to 20 kc for any setting.

**Input Resistance:** 10,000 ohms. This value is engraved on the panel.

**Output Resistance:** Varies with output setting, depending primarily on the setting of the highest decade in use.

**Maximum Input Voltage:** 230 volts rms (or dc) for  $40^\circ$  Centigrade rise of resistors in the input decade. This value is engraved on the panel.

**Resistance Units:** TYPE 510 (see page 170). Unifilar on mica for two decades. Third and fourth decades are Ayrton-Perry on phenolic cards.

**Temperature Coefficient:** Of the individual resistors, less than  $\pm 0.002\%$  per degree Centigrade. Since the voltage ratio is determined by the ratio of resistors of similar construction, the temperature coefficient of the voltage ratio is very nearly zero at normal room ambient temperatures and within the power rating of the box.

**Terminals:** Jack top binding posts with standard  $\frac{3}{4}$ -inch

spacing at input and output. A separate ground post is provided, so that the divider circuit can be used grounded or ungrounded, with the shield grounded.

**Mounting:** Aluminum panel and cabinet.

**Dimensions:** (Length)  $15\frac{3}{4}$  x (width)  $5\frac{1}{4}$  x (height) 5 inches, overall.

**Net Weight:**  $7\frac{1}{4}$  pounds.

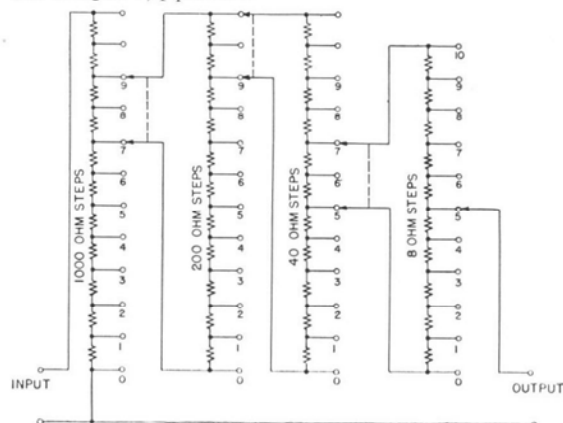

Type	Code Word	Price
1454-A   Decade Voltage Divider.....	ABACK	\$135.00



## TYPE 500 RESISTOR

The TYPE 500 Resistors are particularly recommended as resistance standards for use in impedance bridges and as secondary standards for laboratory use. The plug-type terminals make them readily interchangeable in experimental equipment. Screw terminals are also supplied for more permanent installations. Resistors are similar in construction to those used in TYPE 510 decades. (Page 170.)

This resistor is an accurately adjusted resistance unit wax-sealed in a phenolic case to exclude moisture and to provide protection from mechanical damage.

**FEATURES:** ➤ Convenient and accurate  
 ➤ Negligible thermal emf to copper  
 ➤ Low temperature coefficient of resistance  
 ➤ Excellent high-frequency characteristics  
 ➤ Standard  $\frac{3}{4}$ -inch terminal spacing for plug-in use

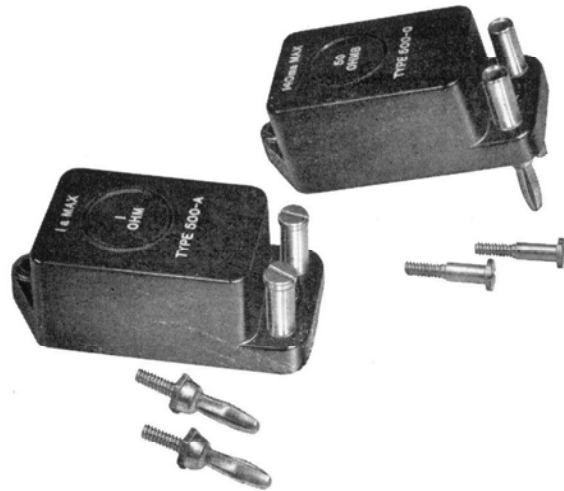

### SPECIFICATIONS

**Accuracy of Adjustment:**  $\pm 0.05\%$  at the terminals, except for the 1-ohm unit, which is adjusted within  $\pm 0.15\%$ .

**Frequency Characteristics:** Similar to those of the TYPE 510 Decade-Resistance Units for resistance values up to 600 ohms; somewhat better for higher resistances, because of the relatively small shunt capacitance of an isolated resistor.

**Maximum Power and Current:** All units will dissipate one watt for a temperature rise of  $40^\circ$  Centigrade. The value of current for this rise is given in the table below and is engraved on each unit.

**Temperature Coefficient:** Less than  $\pm 0.002\%$  per degree Centigrade at normal room temperature.

**Type of Winding:** Less than 200 ohms, Ayrton-Perry; 200 ohms and higher, unifilar on thin mica cards. TYPES 500-V, W, and X are made up of multiple mica cards in series.

**Terminals:** Both terminal screws and plugs are supplied. Each terminal stud is recessed as a jack to accommodate a plug. Standard  $\frac{3}{4}$ -inch spacing is used. High terminal is marked H.

**Mounting:** Black molded phenolic case is used for all units having a resistance of less than 1000 ohms. For units having a resistance value of 1000 ohms or higher, a low-loss mica-filled phenolic case is used. Both types are sealed with a high-melting point wax. TYPES 500-A through -V are in small case; TYPES 500-W and -X in large case.

**Dimensions:** Small case, (length)  $2\frac{3}{4}$  x (width)  $1\frac{3}{16}$  inches. Two mounting holes, spaced  $2\frac{1}{4}$  inches, No. 16 drill. Large case, (length)  $3\frac{13}{16}$  x (width)  $2\frac{1}{8}$  inches. Two mounting holes, spaced  $3\frac{1}{8}$  inches, No. 2 drill.

**Net Weight:** 2 ounces.

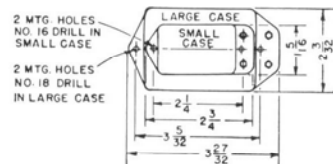

Type	Resistance in Ohms	Maximum Current	Code Word	Price
500-A	1	1.0 a	RESISTBIRD	\$ 4.50
500-B	10	310 ma	RESISTDESK	4.50
500-K	20	220 ma	RESISTFILM	4.50
500-C	50	140 ma	RESISTFORD	4.50
500-D	100	100 ma	RESISTFROG	4.50
500-E	200	70 ma	RESISTGIRL	4.50
500-F	500	45 ma	RESISTGOAT	4.50
500-G	600	40 ma	RESISTGOOD	4.50
500-H	1000	30 ma	RESISTHYMN	4.50
500-L	2000	22 ma	RESISTBELL	4.50
500-M	5000	14 ma	RESISTPIPE	4.50
500-J	10,000	10 ma	RESISTMILK	4.50
500-R	20,000	7 ma	RESISTBARN	4.50
500-T	50,000	4.5 ma	RESISTGULL	4.50
500-U	100,000	3 ma	RESISTROLL	4.50
500-V	200,000	2.2 ma	RESISTVOTE	7.00
500-W	500,000	1.4 ma	RESISTWALL	13.50
500-X	1 Megohm	1.0 ma	RESISTHULL	22.50

**POTENTIOMETERS.** General Radio 970-series potentiometers are listed on page 231.

# SOUND- AND VIBRATION-MEASURING EQUIPMENT

Measurement is an essential element in the efficient evaluation and control of noise and vibration. The necessary measurements are made possible by General Radio's comprehensive line of instruments.

These instruments are a result of a continuing development program since 1933, when General Radio announced its first noise meter. The standard sound-level meter, which is the basic sound-measuring instrument, has been improved in each successive model in performance, in convenience, and in versatility, culminating in the present TYPE 1551-A Sound-Level Meter.

This instrument conforms to the American Standard on Sound-Level Meters.\* An excellent, general-purpose microphone is supplied as standard equipment; but other transducer systems, the TYPE 759-P25 Dynamic Microphone Assembly, the TYPE 1551-PII and TYPE 1551-PIH Condenser Microphone Systems, and the TYPES 759-P35 and P36 Vibration Pickup and Control Box are available for specialized measurements. Their characteristics are tabulated on the next page.

The TYPE 1555-A Sound-Survey Meter is a simplified version of the sound-level meter, particularly designed for convenience in use, small-size, and low cost, and it is widely used when a single measuring instrument is satisfactory.

Either one of these instruments can be used to measure over-all level, and this value is the first important measure of a noise. A frequency analysis is also desirable in order to track down the source of the noise and to determine efficient control measures. For that reason the TYPE 1551-A Sound-Level Meter is designed to provide an output that is the amplified electrical replica of the acoustic signal at the microphone. This output signal can then be analyzed on a frequency basis by one or more of the General Radio analyzers, such as the TYPE 1550-A Octave Band Noise Analyzer, the TYPE 760-B Sound Analyzer, and the TYPE 736-A Wave Analyzer. A general description of these analyzers is given in the section on wave analysis (see page 223).

Satisfactory noise measurements depend on the use of measuring equipment that is kept in proper operating condition. Although the instruments are inherently reliable and stable, after long periods of use their performance

may change. In order to insure that important changes will be discovered and corrected, the TYPE 1552-B Sound-Level Calibrator has been developed. It provides a calibration of the over-all system at 400 cps. When driven by a 400-cycle oscillator at a 2-volt level and mounted on any of the microphones listed below, it supplies a known acoustic signal to the microphone. The TYPE 1307-A Transistor Oscillator is available as a convenient source for driving the calibrator.

The measurement of impact noise has previously required an extensive instrumentation setup, including a cathode-ray oscillograph. The development of the TYPE 1556-A Impact Noise Analyzer has now made it possible to obtain useful measurements on these impact noises with a simple setup, consisting of the TYPE 1551-A Sound-Level Meter and a TYPE 1556-A Impact Noise Analyzer.

With these instruments, one can make the measurements that are necessary for evaluating practically any industrial noise problem. They can be used by non-technical personnel and are designed for long life and trouble-free operation. The use of these and other noise-measuring instruments is discussed thoroughly in the *Handbook of Noise Measurement*, published by the General Radio Company, and available at one dollar a copy, postpaid.

The General Radio line of vibration measuring equipment includes the TYPE 761-A Vibration Meter, which is used to measure the acceleration, velocity, and displacement of a vibrating element, and the TYPE 762-A Vibration Analyzer, which is used to analyze the vibration into its components. A vibration pickup, TYPE 759-P35, is also available to convert the sound-level meter to a vibration meter.

Another important group of vibration instruments are stroboscopes, (see page 191) which permit vibrating objects to be viewed intermittently and produce the optical effect of slowing down or stopping a periodic vibration.

A booklet, entitled *Measurement of Vibration* discusses the use of these instruments in typical vibration measurements. A copy will be mailed, free of charge, on request.

\* American Standard for Sound-Level Meters for the Measurement of Noise and Other Sounds (Z24.3-1944); American Standards Association, 70 East 45th St., New York 17, N. Y.



## INSTRUMENTS

Type	Instrument	Application	Page
1551-A	Sound-Level Meter	Accurate measurement of noise level; measurement where analysis is required; measurements for conformity to noise test codes	178
1555-A	Sound-Survey Meter	Preliminary noise surveys; routine checks; quick tests where an inconspicuous meter or extreme portability is desired	183
1550-A	Octave-Band Analyzer	Analysis of wide-band noises; evaluation of speech-interference level and loudness	185
760-B	Sound Analyzer	Analysis of pitched sounds, where a knowledge of individual frequency components is desirable	186
736-A	Wave Analyzer	Accurate measurement of individual frequency components of definite and stable pitch	224
1556-A	Impact Noise Analyzer	Analysis of impact-type sounds and vibrations. Measurement of peak amplitude and duration of impulse-type signals	187
1552-B	Sound-Level Calibrator	Over-all acoustic check of calibration of sound-level meters, sound-survey meters, and analyzers and for establishing reference levels	184
761-A	Vibration Meter	Vibration measurements down to 2 cps	188
762-B	Vibration Analyzer	Analysis of frequency components of vibration down to 2.5 cps	190
1307-A	Transistor Oscillator	Test-tone source for TYPE 1552-B Sound-Level Calibrator	109

## TRANSDUCERS USED WITH SOUND-LEVEL METER

Type	Name	Uses	Sensitivity db re 1 volt/ $\mu$ bar	Useful Level Range db re 0.0002 $\mu$ bar	Freq- Range Cycles/ Sec.	Maxi- mum Temper- ature, °C	Maxi- mum Humid- ity, %	See Page No.
759-310	Rochelle-Salt Crystal Microphone	Supplied with TYPE 1551-A Sound-Level Meter, General purpose (not recommended for use with long cable)	-56 to -60	24 to 140 To 154 with aux. atten- uator <sup>1</sup>	20-8000	45	80	
759-P25	Dynamic Microphone Assembly	Replaces 759-310 when long cable is needed, and when temperature or humidity prevent use of crystal microphone	-56 to -60	24 to 140	35-10,000	75	100	181
1551-P1L	Condenser Microphone System	Replaces 759-310 for wide-frequency-range measurements; can be used with long cable	-56 to -60	50 to 140 To 150 with aux. attenuator <sup>1</sup>	20-18,000	100	80	180
1551-P1H	High-Level Condenser Microphone System	Replaces 759-310 for high-level and wide-frequency-range measurements; can be used with long cable	-70 to -76	70 to 160 To 170 with aux. attenuator <sup>1</sup>	20-18,000	100	80	180
759-P35 and 759-P36	Vibration Pickup and Control Box (Rochelle Salt Crystal Acceler- ometer)	Replaces 759-310 for vibration measurements	800 mv/g to 1000 mv/g	0.3 to 3900 in./sec. <sup>2</sup> 0.001 to 31 in./sec. 30 $\mu$ in. to 0.25 in.	20-1200	45	80	182

1. TYPE 1551-P11 20 db Attenuator Pad which plugs into "filter in" and "filter out" jacks on sound-level meter panel will provide necessary attenuation.

2. Rochelle Salt Crystal Units may be permanently damaged if exposed to high humidity for long periods. The condenser microphones will not be permanently damaged, but will become noisy and inoperative as moisture reduces the insulation resistance between the active plates of the condenser. Storing microphone in dessicator is recommended.

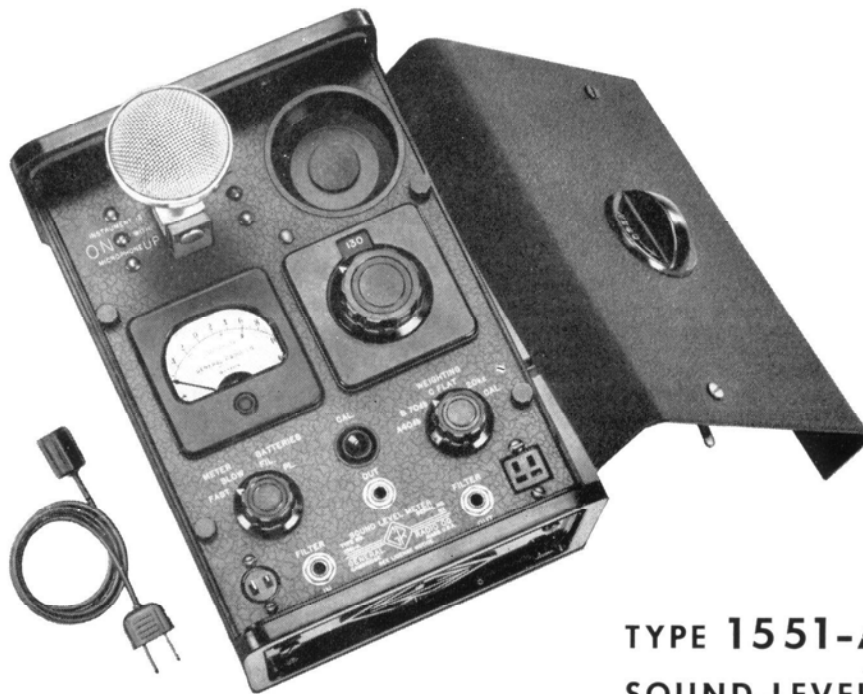

**TYPE 1551-A**  
**SOUND-LEVEL METER**

**USES:** This accurate, portable instrument measures the sound-pressure level at its microphone. In its *primary* function as a noise meter, this sound-level meter is the accepted instrument for the measurement of both product noise and environmental noise by industry, commercial laboratories, regulatory bodies, and noise-abatement groups.

Typical users include:

Machine and appliance manufacturers, in the development laboratory as well as on the production line. It provides a means of establishing noise standards and of accepting or rejecting products on the basis of noise tests.

Acoustical engineers and physicists, for the measurement of noise produced by machinery and for determining the acoustic properties of buildings, vehicles, and materials.

Industrial hygienists and psychologists, in surveys of the psychological and physiological effects of noise, and for the determination of satisfactory noise environments in factories and offices.

*Secondly*, this sound level meter constitutes, with its accessories, a complete sound measuring system. The available accessories include:

Continuous spectrum analyzer (page 186) for the frequency analysis of pitched sounds.

Octave band analyzer (page 185) for rapid spectrum analysis of broad-band noises and for

measurement of loudness and speech interference levels.

Impact analyzer (page 187) for evaluating impact-type sounds.

Wide-range microphone for high-fidelity measurements (page 180).

Dynamic microphone (page 181) for use at remote locations where a long cable is necessary between microphone and meter or where extremes in temperature or humidity are encountered.

Vibration pickup (page 182) for the measurement of solid-borne vibrations.

Acoustic calibrator (page 184) for over-all acoustic checks of sensitivity.

Other types of microphones can also be used, and other accessories, such as graphic level recorders and tape recorders, can be operated from the sound-level meter.

In addition to its application in sound and noise measurement, this instrument can also be used as a portable amplifier, attenuator, and voltmeter for laboratory measurements in the audio frequency range.

**DESCRIPTION:** The Type 1551-A Sound-Level Meter consists of a non-directional microphone, a calibrated attenuator, an amplifier, weighting networks to approximate the response of the human ear to pure tones, and an indicating meter.



The complete instrument, including batteries, is mounted in an aluminum case with an easily removed cover over the panel. The microphone is mounted on a bracket and folds down into a panel recess when not in use. In this storage position of the microphone, batteries are automatically turned off. An a-c power supply unit is available.

**FEATURES:** ➤ Small, compact, and easily portable — weighs only 11 pounds with batteries.  
 ➤ Simple to operate.  
 ➤ Meets all standards of the American Standards Association, the American Institute of Electrical Engineers, and the Acoustical Society of America.

- Separate output systems for panel meter and output terminals. When a sound analyzer is used, meter can be used for monitoring.
- Two-speed meter movement permits measurement of either steady or fluctuating sounds.
- Wide range — from 24 to 140 db.
- Sub-miniature tubes in negative feedback amplifier circuits provide excellent stability.
- Batteries are readily available.
- Amplifiers and panel meter have wide frequency response, 20 cycles to 20 kilocycles.
- Low internal noise level.
- Internal calibration system for standardizing amplifier gain.

**SPECIFICATIONS**

**Sound-Level Range:** From 24 db to 140 db (re 0.0002 microbar).

**Frequency Characteristics:** Any one of four response characteristics, A, B, C, and 20 kc, can be selected by a panel switch.

The A, B, and C weighting positions are in accordance with American Standard Specification on sound-level meters (American Standards Association).

The A and B weighting positions approximate the response of the ear to pure tones referred to a 40-db level and a 70-db level, respectively, at 1000 cps.

The C weighting provides uniform response to all frequencies within the range of the microphone. This characteristic is used for measuring high sound levels, for measuring sound-pressure levels, or when the instrument is used with an analyzer.

The 20 kc position allows the use of the complete frequency response of the sound-level meter's amplifier, which is flat from 20 c to 20 kc, so that complete use can be made of wide-range microphones such as the General Radio TYPE 1551-P1 Condenser Microphone Systems. Filter jacks are provided to permit modification of frequency characteristics by insertion of special networks.

**Microphone:** The microphone is a high-quality Rochelle-salt-crystal diaphragm type. Condenser and dynamic microphones are available as accessories. See page 180.

**Sound-Level Indication:** The sound level is indicated by the sum of the readings of the meter and attenuator switch. The clearly marked, open-scale meter covers a span of 16 db with calibration from -6 to 10 db. The attenuator is calibrated in 10-db steps from 30 to 130 db above the standard reference level.

**Output:** An output of 1 volt across 20,000 ohms (when the panel meter is at full scale) is available at an output jack. The output can be used to drive frequency analyzers, recorders, and oscillographs.

**Meter Damping:** The panel meter is provided with two different damping characteristics, selected by a switch. In the FAST position, the meter ballistics agree with the current ASA standards. In the SLOW position, the meter is heavily damped and indicates, for easy reading, the average level of rapidly fluctuating sounds.

**Calibration:** Means are provided for standardizing the sensitivity of the electrical circuits in the sound-level meter by comparison with a voltage derived from a

105-125 volt a-c power line. After standardization, the accuracy of sound-level measurements, as specified in ASA standards, is within  $\pm 1$  db for average machinery noise. The TYPE 1552-B Sound-Level Calibrator (page 184) is available for making periodic acoustic checks on the over-all calibration, including microphone.

**Temperature and Humidity Effects:** Readings are independent (within 1 db) of temperature and humidity over normal ranges of room conditions.

**Power Supply:** Two 1½-volt size D flashlight cells (Rayovac 2LP or equivalent) and one 67½-volt Burgess XX45 battery or equivalent are supplied. The TYPE 1262-A Power Supply for a-c operation is available.

**Tube Complement:** Four Raytheon CK-512-AX and three Raytheon CK-533-AX tubes.

**Accessories Supplied:** TYPE CAP-11 Power Cord for calibration checks; telephone plug.

**Accessories Available:** See pages 180 to 187.

**Cabinet:** Shielded aluminum and plastic cabinet, with cover, which also serves as a convenient and rugged carrying case.

**Dimensions:** (height) 6 5/8 x (length) 10 13/16 x (width) 8 7/8 inches.

**Net Weight:** 11 pounds with batteries.

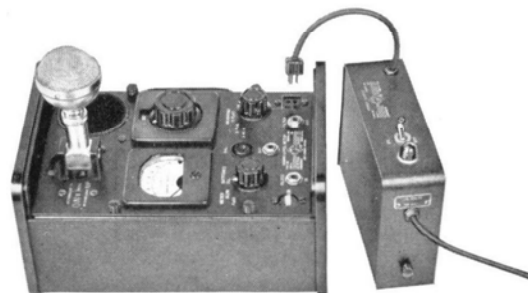

Batteries are furnished with the Sound-Level Meter. For a-c operation, the TYPE 1262-A Power Supply attaches to the sound-level meter cabinet, as shown above. For complete specifications, see page 147.

Type		Code Word	Price
1551-A	Sound-Level Meter * .....	MIMIC	\$370.00
	Set of Replacement Batteries .....	MIMICADBAT	3.25
1262-A	Power Supply .....	MANLY	70.00

\*PATENT NOTICE. See Note 1, page viii.



## TYPE 1551-P1 CONDENSER MICROPHONE SYSTEM

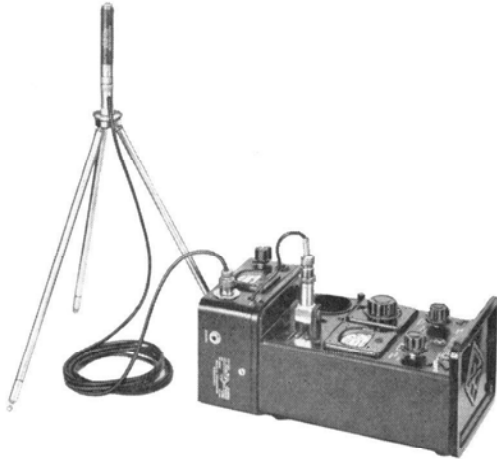

The Type 1551-P1L (for normal-level measurement) and the Type 1551-P1H (for high-level measurement) are condenser microphone systems designed for use with the Type 1551-A Sound-Level Meter for measuring sounds over wide frequency ranges. These microphones are not damaged by high sound

levels or by high temperatures.

Applications include:

Measurement of high-frequency, high-level noises produced by air streams, wood- and metal-working machinery, turbines, and jet engines.

General-purpose sound-level measurements in locations where ambient conditions (temperature, sound-level) are severe.

Measurements on high-fidelity sound reproduction systems over the full audio spectrum.

**DESCRIPTION:** The Type 1551-P1L Condenser Microphone System uses a 21-BR-150 microphone and measures sound pressure level up to 155 db; the Type 1551-P1H, which uses a 21-BR-180 microphone, measures levels up to 170 db.

The microphone base houses a subminiature pre-amplifier tube. A battery-operated power supply, which fastens to the end of the Sound-Level Meter, provides pre-amplifier filament and plate power and polarizing voltage for the microphone. An extension cable, a tripod, and a leather carrying case are supplied.

### SPECIFICATIONS

**Frequency Response:** 20 cycles to 18 kilocycles with either microphone. A typical response curve is shown below.  
**Calibration:** The output level as a function of frequency is measured in our laboratory by comparison with a standard microphone that is calibrated periodically. The measured level at 400 cycles is supplied.

**Direct Use with Analyzers:** These assemblies can supply a signal directly to the TYPE 1550-A Octave-Band Noise Analyzer or the TYPE 760-B Sound Analyzer, provided that the level of the measured components is above 70 db (re 0.0002 microbar) for TYPE 1551-P1L, and 85 db for TYPE 1551-P1H. (A TYPE 1552-B Sound-Level Calibrator is then necessary for absolute level calibration.) An output is provided for this connection.

**Maximum Sound-Pressure Level:**

For the TYPE 1551-P1L Condenser Microphone Assembly, non-linear distortion is below 1% at levels up to 135 db, and less than 10% at 155 db. At levels above 140 db, the TYPE 1551-P1L 20-db Pad must be used to keep the signal within the range of the TYPE 1551-A Sound-Level Meter.

For the TYPE 1551-P1H High-Level Microphone Assembly, non-linear distortion is below 1% up to 150 db and below 10% up to 170 db. At levels above 160 db with the TYPE 1551-P1H system, the TYPE 1551-P1L 20-db Pad is necessary.

**Minimum Measurable Sound-Pressure Level:**

For the TYPE 1551-P1L: 50 db (re 0.0002 microbar).

For the TYPE 1551-P1H: 65 db (re 0.0002 microbar).

**Temperature and Humidity:** Maximum recommended operating temperature of the microphone in its probe is

212° F. The microphone is not damaged by exposure to high humidity, but prolonged exposure may cause electrical leakage and render it temporarily inoperative.

**Batteries:** One 1½-volt size D flashlight cell (Rayovac 21P or equivalent) and one 300-volt B battery (Eveready 493 or Burgess V-200) are supplied.

**Tube Complement:** One Raytheon TYPE CK-512-AX (installed in microphone base assembly).

**Mounting:** The microphone on its base plugs into one end of a 10-foot cable, which has a fitting with standard ¼-20 tripod thread. The other end of the cable is connected to the power supply unit, which fastens to the end frame of the Sound-Level Meter.

**Dimensions:** Leather carrying case is approximately (height) 7 x (length) 5½ x (width) 8½ inches.

**Net Weight:** Complete in carrying case, 7 lbs, 6 oz.

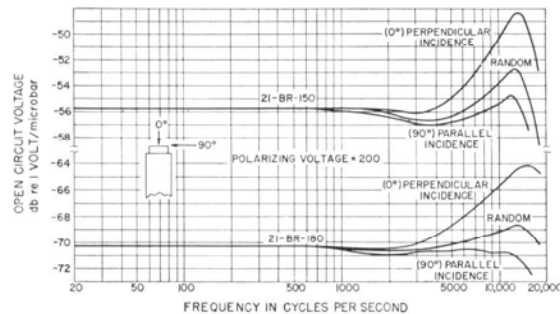

Type	Code Word	Price
1551-P1L	NONAL	\$300.00
1551-P1H	NATAL	300.00
1551-P1L	LABEL	15.00
Set of Replacement Batteries	NONALDBAT	11.15





## STANDARD ACCESSORIES FOR THE TYPE 1551-A SOUND-LEVEL METER

The following accessories are available for use with the TYPE 1551-A Sound-Level Meter to increase its field of application and to adapt

it for specialized types of measurement. These accessories can also be used with the older TYPE 759-B Sound-Level Meter.

### DYNAMIC MICROPHONE ASSEMBLY

For some measurements, particularly where a long cable must be used between microphone and meter, or where large ranges of temperature and humidity are encountered, a dynamic microphone is preferable. The TYPE 759-P25 Dynamic Microphone Assembly includes, in addition to the microphone, a 25-foot cable, an input transformer, and a tripod. The transformer plugs into the Sound-Level Meter in place of the standard microphone, and the microphone cable plugs into the transformer.

### SPECIFICATIONS

**Sensitivity:** Open-circuit output of typical microphone is 90 db below one volt per microbar, and of microphone plus transformer is 60 db below one volt per microbar. This sensitivity is satisfactory for use with both the TYPE 1551-A and the TYPE 759-B Sound-Level Meters. **Direct Use with Analyzers:** Microphone output can be supplied directly to the TYPE 1550-A Octave-Band Noise Analyzer and the TYPE 760-B Sound Analyzer provided the level of the measured components is above

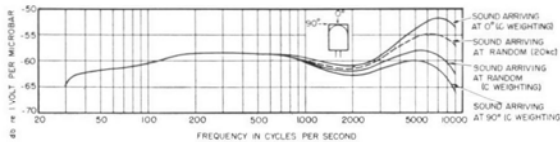

Typical response curves of TYPE 1551-A Sound-Level Meter with TYPE 759-P25 Dynamic Microphone Assembly.



(B) Microphone and transformer plug into the sound-level meter as shown above.

70 db (re 0.0002  $\mu$ bar). (A TYPE 1552-B Sound-Level Calibrator is then necessary to obtain absolute level.)

**Maximum Safe Sound-Pressure Level:** Sound-pressure levels above 140 db can damage the microphone.

**Calibration:** Output level is checked in our laboratories at several frequencies against a standard microphone that is calibrated periodically. The level at 400 cycles is supplied.

**Cable Correction:** No correction is necessary for the 25-foot cable supplied or the TYPE 759-P22 100-foot cable.

**Net Weight:** 4 $\frac{5}{8}$  pounds.

Type		Code Word	Price
759-P25	Dynamic Microphone Assembly.....	NABOR	\$187.25
759-P22	Extra 100-foot cable.....	NASAL	30.00

### 20-DB ATTENUATOR PAD

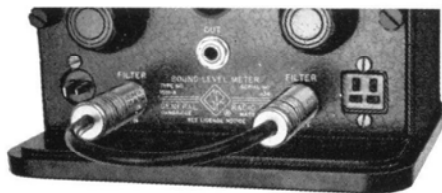

The TYPE 1551-P11 20-db Attenuator Pad extends the range of the TYPE 1551-A Sound-Level Meter upward by 20 db. The pad is a resistive network which reduces over-all instrument gain when it is connected between the "filter-in" and "filter-out" jacks. With this pad and the Rochelle-salt microphone, the range of the instrument becomes 44 to 160 db.

**Net Weight:** 6 ounces.

Type		Code Word	Price
1551-P11	20-db Attenuator Pad.....	LABEL	\$15.00



VIBRATION PICKUP AND CONTROL BOX



The vibration pickup and control box plug into the sound-level meter in place of the microphone, as shown in the photograph above.

Over-all frequency response characteristic of the vibration pickup, control box, and sound-level meter for constant applied acceleration, velocity, and displacement, respectively.

The TYPE 759-P35 Vibration Pickup is an inertia-operated crystal device which generates a voltage proportional to the acceleration of the vibrating body. By means of integrating networks in the control box, voltages proportional to velocity and displacement can also be delivered to the sound-level meter. The desired response is selected by means of a three-point switch on the control box.

SPECIFICATIONS

**Calibration:** The db readings of the sound-level meter can be converted into absolute values of displacement, velocity, or acceleration by means of calibration data supplied.

**Range:** The range of measurement of the pickup and control box when used with the TYPE 1551-A or the TYPE 759-B Sound-Level Meter is approximately as follows:

R-m-s Displacement — 30 micro-inches (minimum).

R-m-s Velocity — 1000 micro-inches per second (minimum). The upper limit of velocity and displacement measurements is dependent on the frequency and is determined by the maximum acceleration permissible before non-linearity occurs (10 g).

R-m-s Acceleration — 0.3 to 3900 in./sec/sec (10 g).

**Net Weight:** TYPE 759-P35 Vibration Pickup, 8 ounces (pickup only); pickup plus 7-foot cable and tips, 1 pound; TYPE 759-P36 Control Box, 1 pound, 13 ounces.

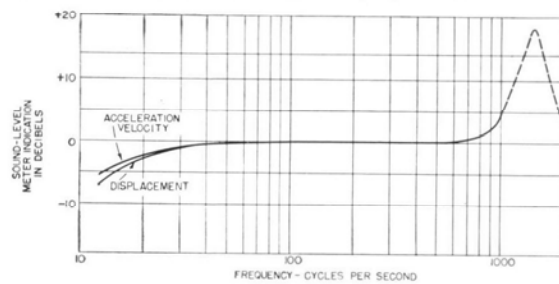

Type		Code Word	Price
759-P35	Vibration Pickup.....	NOSEY	\$40.00
759-P36	Control Box.....	NANNY	65.00

TRIPOD AND EXTENSION CABLE

For measurements where the microphone must be located at a distance from the meter, the TYPE 759-P25 Dynamic Microphone is recommended (see page 181). However, a 25-foot extension cable and tripod for

mounting the Rochelle-salt crystal microphone can be supplied. With this cable a correction curve is furnished, giving the cable correction as a function of temperature of the microphone.

Type		Code Word	Price
759-P21	Tripod and Extension Cable.....	KIMBO	\$33.50

HANDBOOKS

*The Handbook of Noise Measurement*, published by General Radio Company, covers thoroughly the measurement of noise and other airborne sounds. Authors are Dr. A. P. G. Peterson of the General Radio Engineering Staff and Dr. Leo L. Beranek, Associate Professor at the Massachusetts Institute of Technology.

Copies of this handbook are available from the General Radio Company at a price of \$1.00 each, post-paid, in the United States and Canada.

Companion manual is entitled *The Measurement of Vibration*. Written by Ervin E. Gross, Jr., of the General Radio Engineering Staff, the text discusses vibration, its measurement, and analysis.

Copies of this handbook are available free from the General Radio Company.



## TYPE 1555-A SOUND-SURVEY METER

The Type 1555-A Sound-Survey Meter is an inexpensive, pocket-sized instrument for use in general survey measurements.

This handy, versatile meter can be used for:

Measuring noise levels in homes, offices, factories, and outdoor locations.

Measuring noise levels produced by appliances, office equipment, and machinery.

Preliminary surveys of noisy areas for estimating the possibility of hearing damage to personnel.

Measuring level and dispersion pattern of reproduced sound from public-address systems, theater sound systems, and home sound systems.

Surveys by field engineers for acoustic material companies.

Acoustic experiments in physics classes.

Establishing satisfactory levels for speakers and singers, at rehearsal and in classes.

Determining cross-over characteristics and dynamic range of high-fidelity music reproducing systems.

Measuring the frequency-response characteristic of loud speakers and rooms.

**DESCRIPTION:** The Type 1555-A Sound-Survey Meter consists of a non-directional microphone, a continuously-adjustable, calibrated attenuator, a stable amplifier with three



weighting networks, and an easily read indicating meter.

The entire assembly, including microphone and batteries, is housed in a rugged, two-piece, aluminum case. The attenuator and weighting-network selector are fingertip operated. This permits one-hand operation of the instrument.

**FEATURES:** ➤ Small enough to fit in pocket.

➤ Can be used when set on a table, when mounted on tripod, or when held in hand.

➤ Miniature in size, yet it uses standard and well-tested components.

### SPECIFICATIONS

**Range:** From 40 db to 136 db (re 0.0002 microbar). Sound-level is sum of the attenuator and meter indications.

**Frequency Characteristic:** Three different frequency characteristics can be selected by the main control switch. In the *C* and *C*+30 db weighting positions substantially equal response to all frequencies between 40 and 8000 cps is obtained. This characteristic is ordinarily used for all levels above 85 db.

The *B* weighting position is used for levels between 55 and 85 db. Its response follows the 70-db contour established as the standard of weighting for sound-level meters. The *A* weighting position is usually used for levels between 40 and 55 db. Its response follows approximately the 40-db contour established for sound-level-meter weighting. In addition to providing means for making the usual weighted level measurement, these characteristics permit one to estimate, by comparative measurements with different weighting characteristics, the relative importance of low-frequency components in the sound being measured.

**Accuracy:** The *B* and *C* weighting positions are in accordance with the standard for sound-level meters established by the American Standards Association when the tolerance of the standard is increased by 1 db.

The gain of the amplifier is so set that the sensitivity of the instrument is correct at 1000 cps within  $\pm 1$  db.

**Stability:** The amplifier is stabilized by feedback to minimize the effect of changes in battery voltage. Temperature and humidity changes over the normal range of room conditions have no noticeable effect. The temperature coefficient of the sound-level indication is low and is in the order of 0.03 db per degree F.

**Operating Limits:** The maximum safe operating temperature of the instrument is 115° F. Temperatures above 130° F will permanently damage the Rochelle-salt crystal in the microphone.

**Microphone:** A crystal diaphragm-type microphone is mounted at the top of the instrument.

**Batteries:** One 1½-volt size C flashlight battery (Rayovac 1LP or equivalent) and one 30-volt hearing-aid battery (Eveready 413E or equivalent) are supplied.

**Tube Complement:** Two Raytheon CK-512-AX and two Raytheon CK-533-AX tubes.

**Cabinet:** Aluminum, finished in black and has a standard ¼-20 threaded tripod mount. A leather "ever-ready" carrying case is available, which permits operation of the instrument without removal from the case.

**Dimensions:** 6 x 3½ x 2½ inches, over-all.

**Net Weight:** 1 pound, 14 ounces, with batteries.

Type		Code Word	Price
1555-A	Sound-Survey Meter.....	MISER	\$140.00
	Set of Replacement Batteries.....	MISERADBAT	1.65
1555-P2	Leather Carrying Case.....	CAGED	10.00

PATENT NOTICE. See Note 1, page viii.



## TYPE 1552-B SOUND-LEVEL CALIBRATOR



Calibrator fits over microphone as shown above. At left is the TYPE 1307-A Transistor Oscillator.

**USES:** The TYPE 1552-B Sound-Level Calibrator supplies a known acoustic signal for checking the over-all performance of sound-level meters, including the microphone. The calibrator is designed to fit over a number of microphones (see listing under specifications) and can also be used to calibrate the TYPE 1550-A Octave-Band Noise Analyzer or the TYPE 760-B Sound Analyzer when they are used directly with these microphones. It can be used to supply an acoustic reference level for audio systems, provided one of the microphones listed or its equivalent is used.

The TYPE 1307-A Transistor Oscillator is designed to operate with the Sound-Level Calibrator and serves as both oscillator and level indicator.

**DESCRIPTION:** The calibrator has a small, stable loudspeaker mounted in one end of a cylindrical enclosure; the other end is open and fits over the microphone. Acoustical coupling between the speaker and the microphone is fixed by chamber and microphone dimensions. The calibrator provides acoustical shielding as well as a high test level to reduce effects of ambient noise during calibration. These conditions make calibration checks accurate and readily repeatable.

### SPECIFICATIONS

**Input:** 2.0 volts at 400 cycles across 600Ω; harmonic content must be 5% or less.

**Microphones:** The calibrator can be used on the following microphones without the need of special adaptors.

Shure Brothers, TYPE 9898 (Supplied on 1551-A and 759-B Sound-Level Meters)

TYPE 1555-A Sound Survey Meter

GR TYPE 759-P25

GR TYPE 1551-P1L and GR TYPE 1551-P1H

Shure Brothers, TYPE 98B99

Western Electric TYPE 640-AA

Kellogg Microphone.

**Terminals:** Input terminals are TYPE 938-W Binding posts spaced  $\frac{3}{4}$ -inch so as to receive the TYPE 274-MB Double Plug.

**Accessories Required:** A 400-cycle source, with output control and voltmeter. The TYPE 1307-A Transistor oscillator, a battery-operated device with self-contained voltmeter, is recommended (see page 109). The combination of the TYPE 1214-A Unit Oscillator (a-c oper-

ated, see page 112) and the TYPE 1803-B Vacuum-Tube Voltmeter (page 130) are also satisfactory.

**Dimensions:** (length)  $4\frac{1}{2}$  x (diameter)  $2\frac{1}{2}$  inches, overall.

**Net Weight:** 12 ounces.

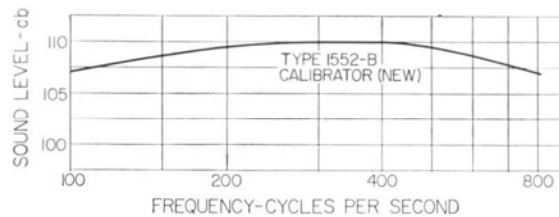

Frequency characteristic of the TYPE 1552-B Sound-Level Calibrator.

Type	Code Word	Price
1552-B	NATTY	\$47.50
1307-A	OMEGA	80.00



## TYPE 1550-A OCTAVE-BAND NOISE ANALYZER

**USES:** The Octave Band Noise Analyzer is used for the simple and rapid analysis of broadband noises, where a knowledge of individual frequency components is not required.

It is particularly useful for:

Noise measurements on aircraft, vehicles, and machinery;

The analysis of environmental noise, as in offices and factories, where speech-interference level is important;

Studies of environmental noise as related to hearing damage;

Production testing and noise-level acceptance tests.

It is also useful in studies of the acoustic characteristics of rooms and of materials.

**DESCRIPTION:** The Octave-Band Noise Analyzer is portable, battery-powered, and operates from the output of a sound-level meter, or, when the level is sufficiently high, directly from a microphone. It contains eight band-pass filters, any one of which can be selected by a switch; an attenuator; and an amplifier, which drives both an indicating meter and a monitoring output.

**FEATURES:** ➤ Movable reference dial on attenuator to facilitate reading.

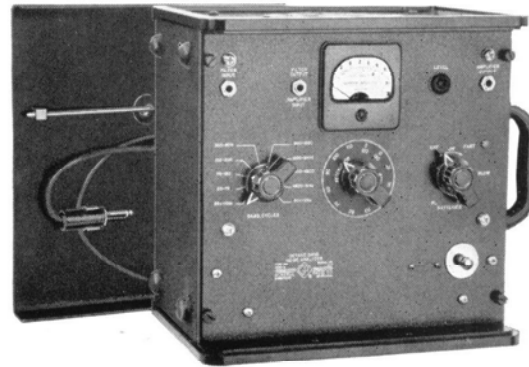

- Monitoring output is provided.
- Meets A. S. A. standards.
- Operates from output of the TYPE 1551-A or the TYPE 759-B Sound-Level Meter as well as other sound-level meters with outputs adequately free from noise and distortion.
- Can be used directly with microphone for high sound levels.
- Amplifier input jack permits amplifier to be used alone.
- A-C power supply can be substituted for batteries for laboratory use.
- Filters can be used alone for other types of measurements.

### SPECIFICATIONS

**Range:** 20 cycles to 10,000 cycles in 8 bands,  
 20 c to 75 c (low pass)    600 c to 1200 c  
 75 c to 150 c                1200 c to 2 000 c  
 150 c to 300 c               2 000 c to 4800 c  
 300 c to 600 c               4800 c to 10,000 (high pass)

In addition, a band with a flat characteristic from 20 c to 10 kc is available at two switch positions for convenience in calibration against the sound-level meter.

**Input Level:** Between 1 and 10 volts for normal range. Levels below one volt reduce the range of reading; those higher than 10 volts overload the filters.

**Input Impedance:** 20,000 ohms. Input is isolated by a resistance pad, so that performance is independent of source if source impedance is constant over audio range or is small compared to 20,000 ohms.

**Source:** Sound-level meter supplying analyzer input must have low hum, low internal noise, and low distortion. The TYPE 1551-A Sound-Level Meter is recommended.

**Direct Use with Microphone:** The TYPE 1551-P1L and -P1H Condenser Microphone Systems or the TYPE 759-P25 Dynamic Microphone Assembly can be used if the band levels exceed 70 db, 85 db, and 70 db, respectively (re 0.0002  $\mu$ bar). A TYPE 1550-P1 Microphone

Adaptor Plug is required with the TYPE 759-P25 Dynamic Microphone Assembly.

**Level Indication:** Level is sum of meter and attenuator readings.

**Attenuation:** Except for the lowest and highest bands, at least 30-db attenuation is obtained at one-half the lower nominal cut-off frequency and twice the upper nominal cut-off frequency; at least 50-db attenuation is obtained at one-fourth the lower nominal cut-off frequency and at four times the upper nominal cut-off frequency. The 75-cycle low-pass filter has at least 30-db attenuation at 200 c and 50 db at 400 cycles. The 4800-cycle high-pass filter has at least 30-db attenuation at 2400 cycles and 50 db at 1200 cycles.

**Accessories Supplied:** Dial and dial clamp; shielded cable for connecting analyzer to sound-level meter.

**Tube Complement:** Three 1U4 and one 1T4.

**Power Supply:** Battery, Burgess 6TA60. Battery is included in price. For a-c operation, TYPE 1261-A Power Supply (page 147) fits battery compartment.

**Dimensions:** (Width) 11  $\frac{3}{4}$  x (height) 12  $\frac{9}{16}$  x (depth) 9 inches, over-all.

**Net Weight:** 27 pounds including battery.

Type		Code Word	Price
1550-A	Octave-Band Noise Analyzer.....	ABEAM	\$535.00
	Replacement Battery for above.....	ABEAMADBAT	6.25
1550-P1	Microphone Adaptor Plug.....	MATOR	4.00
1261-A	A-C Power Supply.....	NUTY	128.00



## TYPE 760-B SOUND ANALYZER

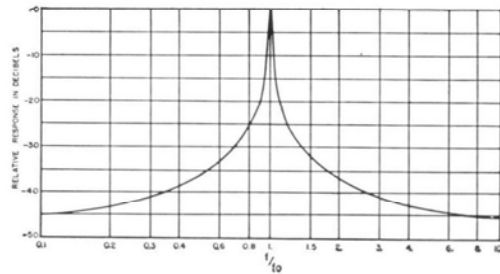
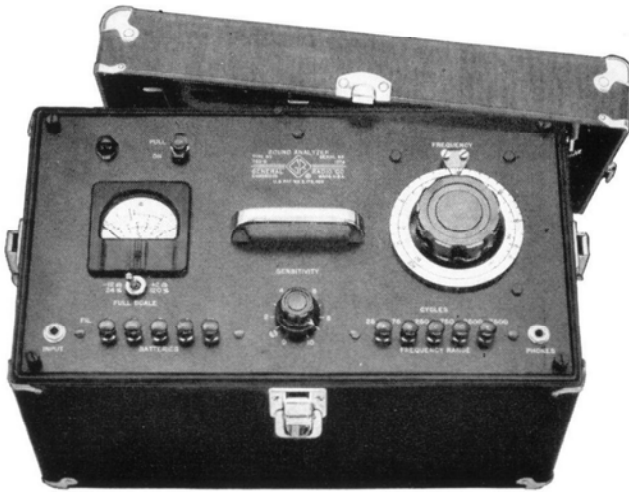

**USES:** The Sound Analyzer is a continuous-spectrum instrument, which measures the amplitude of each frequency component in a complex sound. It is recommended for the analysis of sounds having definite pitch, such as those produced by engines and motors, appliances and machines operating at essentially constant speeds, and of sounds whose components are harmonically related. It is particularly valuable in identifying the sources of pitched sounds in machines.

The Sound Analyzer is also a useful general-purpose electric-wave analyzer for the audio

range, and a tuned null indicator for use with impedance bridges.

**DESCRIPTION:** The Sound Analyzer is a tunable voltmeter whose band width is a constant percentage of the center frequency. It consists of a three-stage direct-coupled amplifier with a tunable null circuit in a negative-feedback loop. It is battery powered and portable, and operates from the output of the sound-level meter, or, when component sound levels are high enough, directly from a microphone. Operation is unaffected by ordinary electro-magnetic and electrostatic fields.

### SPECIFICATIONS

**Frequency Range:** From 25 to 7500 cps in five ranges: 25 to 75, 75 to 250, 250 to 750, 750 to 2500, and 2500 to 7500 cycles.

**Frequency Calibration Accuracy:**  $\pm 1.5\%$  of the frequency dial setting or  $\pm 1.5$  cps, whichever is the larger.

**Input Voltage Range:** 1 millivolt to 10 volts for usable indications. Meter scale indicates component tones down to 1% of fundamental or loudest tone.

**Frequency Response:** Flat within  $\pm 2$  db over entire range. Where ranges overlap, the sensitivity is the same on either range, within  $\pm 1$  db.

**Band Width:** 2% of selected frequency — relative attenuation is 3 db at 1% off peak frequency.

**Direct Use With Microphone:**

Microphone Type	Component Levels Must Exceed
759-P25*	70 db
1551-P1L	70 db
1551-P1H	85 db

\* Type 1550-P1 Adaptor Plug required.

**Input Impedance:** Between 20 k $\Omega$  and 30 k $\Omega$  (dependent upon setting of sensitivity control).

**Temperature and Humidity Effects:** Under very severe conditions slight shifts in frequency calibration, sensitivity, and bandwidth may occur.

**Meter:** Two ranges, +2 to -30 db and -12 to -40 db. Auxiliary percentage ranges of 0 to 120% and 0 to 24%.

**Output:** An output jack is provided for aural monitoring of the filtered signal. This feature is also useful when the analyzer is used as a bridge-balance indicator.

**Tube Complement:** Three 1L4, one 1U4, one neon lamp (NE-51).

**Batteries:** Four 1.5-volt batteries (Burgess 2FBP), three 45-volt batteries (Burgess Z30NX). Batteries are supplied with instrument.

**Accessories Supplied:** Shielded cable-and-plug assembly for connecting analyzer to sound-level meter.

**Case:** Shielded, airplane-luggage-type carrying case.

**Dimensions:** (Length) 18 x (width) 10 x (height) 11½ inches, over-all.

**Net Weight:** 36½ pounds, with batteries.

Type		Code Word	Price
760-B	Sound Analyzer.....	ATTAR	\$520.00
	Set of Replacement Batteries for above...	ATTARADBAT	13.10
1550-P1	Microphone Adaptor Plug.....	MATOR	4.00

PATENT NOTICE. See Note 14, page viii.



## TYPE 1556-A IMPACT NOISE ANALYZER

The Impact Noise Analyzer evaluates the characteristics of impact-type sounds, which cannot be measured adequately by conventional noise-measuring equipment designed for steady-state measurements. Such noises include those produced by punch presses, forging hammers, fire-arms, pile drivers, office machinery and similar equipment. From the standpoint of hearing damage, these sounds constitute a serious problem for industry. They have hitherto been measurable only with complicated methods employing a cathode-ray oscillograph.

The two characteristics of impact sounds that seem most significant are the peak amplitude and the duration, or decay time. This analyzer measures both these quantities and, in addition, a quasi-peak value that is useful in determining the variation among peak values in repetitive impacts.

The Impact Noise Analyzer is designed to operate from the output of a TYPE 1551-A Sound-Level Meter and, when the microphone on the sound-level meter is replaced by a vibration pickup (page 182), will evaluate the vibration impact characteristics of the device being studied.

Additional applications include the measurement of reverberation time and some types of loudness studies.

**DESCRIPTION:** The Impact Noise Analyzer contains a battery-operated, degenerative,

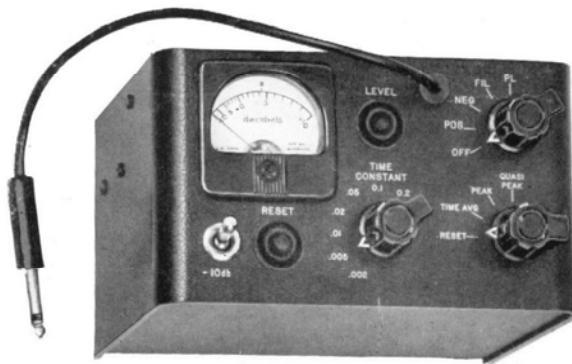

transistor amplifier, simultaneously driving three a-c voltmeter circuits, which consist of rectifiers, storage capacitors, and a common d-c electronic voltmeter. The electrical storage system (a capacitor charged by a rectifier) makes it possible to measure three characteristics, the peak, quasi peak, and time average, of a single impact with only one indicating meter. Peak value is the maximum sound pressure level reached by the noise; quasi peak is a continuously indicating measure of the high sound-pressure levels reached just before the time of indication; and time average is a measure of the average level over a predetermined period of time, which, when subtracted from peak level is a measure of the time duration of the sound.

### SPECIFICATIONS

**Input:** Any voltage between 1 and 10 volts for normal range. Inputs below 1 volt reduce the range of reading.

**Input Impedance:** Between 25,000 and 100,000 ohms, depending on the setting of the LEVEL control.

**Frequency Range:** 5 c to 20 kc.

**Level Indication:** Meter calibrated in decibels from -10 to +10. Attenuator switch increases range by 10 db.

**Peak Reading:** Rise time is less than 50 microseconds for a value within 1 db of peak value (for rectangular pulses). Storage time at normal room temperature is greater than 10 seconds for 1 db decrease in value.

**Quasi Peak Reading:** Rise time of less than  $\frac{1}{4}$  millisecond and decay time of  $600 \pm 120$  milliseconds for rectifier circuit.

**Time Average Reading:** Charge time of rectifier circuit selected by seven-position switch, having times of .002, .005, .01, .02, .05, .1, and .2 seconds for the resistance-capacitance time constant. Storage time at normal room temperature is greater than 1 minute for 1 db decrease in value.

**Auxiliary Instruments Required:** A sound-level meter or frequency analyzer to supply the analyzer input.

**Input Terminals:** Cord with phone plug at one end.

**Batteries:** One  $1\frac{1}{2}$ -volt size D flashlight cell (Rayovac 2LP or equivalent) and one 45-volt B battery (Burgess XX30 or equivalent) are supplied.

**Transistors:** Three TYPE 2N105 or equivalents.

**Tube Complement:** One TYPE CK-6418.

**Cabinet:** Aluminum, finished in organic black. Carrying case supplied.

**Mounting:** May be fastened to end frame of TYPE 1551-A Sound-Level Meter.

**Dimensions:**  $7\frac{1}{2}$  inches (wide) x  $4\frac{1}{4}$  inches (deep) x  $6\frac{1}{2}$  inches (high).

**Net Weight:**  $4\frac{1}{2}$  pounds; carrying case, 1 pound.

Photo at right shows how Impact Noise Analyzer attaches to Sound-Level Meter.

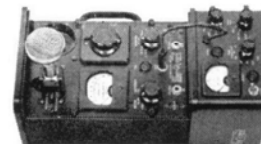

Type	Code Word	Price
1556-A   Impact Noise Analyzer	MEDAL	\$210.00

GENERAL RADIO COMPANY

187



## TYPE 761-A VIBRATION METER

**USES:** Vibrations in machines and structures can be measured quickly and easily with this instrument. For the manufacturer of machinery and equipment, the TYPE 761-A Vibration Meter is extremely useful in research, design, and production testing. Maintenance engineers will find it useful for checking the operating condition of bearings, gear trains, and other mechanisms. Excessive vibrations due to improper adjustment or to structural resonances can be located and measured.

Its excellent low-frequency response permits the study of the operation of belt drives and of the effectiveness of mountings designed to reduce vibrations in adjacent structures.

A frequency analysis of the measured vibration can be made with the TYPE 762-B Vibration Analyzer (page 190).

**DESCRIPTION:** The TYPE 761-A Vibration Meter consists of: an inertia-operated, Rochelle-salt, crystal pickup, which delivers a voltage proportional to the acceleration of the vibratory motion; an adjustable attenuator; an amplifier; and a direct-reading indicating meter. An integrating network can be switched to convert the output of the vibration pickup

to a voltage proportional to either displacement or velocity.

The Vibration Meter reads directly in root-mean-square inches, inches per second, and inches per second per second.

Accessories include various tips and an eight-inch metal probe for the pickup to facilitate measurements in normally inaccessible places. Available at additional cost is the TYPE MAP-2-S1 Permanent-Magnet Clamp, which replaces the probe or tip when measurements are taken under conditions where hand-held operation would not be satisfactory. The accompanying illustration shows the magnetic clamp in use.

**FEATURES:** > Portable and self-contained.

- > Easy to operate.
- > Direct reading.
- > Low-frequency response down to 2 cycles per second.
- > Independent output system for panel meter and output jack.
- > Semi-logarithmic meter scale permits wide range of measurement with a single multiplier setting.





**SPECIFICATIONS**

**Ranges:** The vibration meter is direct reading in the following ranges:

**Displacement:** 16 micro-inches to 30 inches, rms.  
**Velocity:** 160 micro-inches per second to 300 inches per second, rms.

**Acceleration:** 0.160 inch per second per second to 3900 inches per second per second, rms. (0.0004g to 10g).

**Response Characteristics:** The response follows the theoretical curves shown below within the following tolerances.

Quantity	Range	Tolerance	Frequency Range
<b>Acceleration</b>	0.160 in./sec/sec to 3900 in./sec/sec	±10%	4 to 500 cps
<b>Velocity</b>	1600 μin./sec to 300 in./sec	±10%	5 to 500 cps
<b>Velocity</b>	Below 1600 μin./sec	±15%	20 to 500 cps
<b>Displacement</b>	160 μin. to 30 in.	±10%	10 to 500 cps
<b>Displacement</b>	Below 160 μin.	±15%	20 to 500 cps

Above 500 cps the error increases and may reach ±30% at 1000 cps. This is caused by the differences in response of individual pickups near resonance.

**Pickup Unit:** Inertia-operated, Rochelle-salt-crystal type. Output of pickup is 0.800 volts per g. Non-linearity occurs at 10 g or 3900 inches per second per second. Point and ball tips and an 8-inch extension rod are supplied.

**Meter:** Scale reads directly in the quantity being measured—root-mean-square micro-inches for displacement, root-mean-square micro-inches per second for velocity, and root-mean-square inches per second per second for acceleration.

**Attenuators:** A 10-step attenuator changes the meter scale range by a factor of 30,000 to 1. Additional multipliers indicate the correct units of measurement and multiplying factors for each response characteristic.

**Calibration:** Connection to any a-c power line makes it possible to check the over-all calibration excluding pickup.

**Terminals:** A jack is provided on the panel for plugging in a pair of head telephones in order to listen to the vibrations being measured, for connecting the TYPE 762-B Vibration Analyzer, or for connecting a cathode-ray oscillograph.

**Tube Complement:** One CK-512-AX, two 1N5-GT and one 1D8-GT are required.

**Battery:** A single self-contained battery unit, (Ray-O-Vac No. AB64 or equivalent), which supplies the necessary plate and filament voltages, is included.

**Accessories Supplied:** TYPE 761-P1 Vibration Pickup, power cable for calibration check, spare pilot lamp, and plug for output jack.

**Case:** Shielded carrying case of airplane-luggage construction.

**Dimensions:** (Height) 12½ inches x (length) 13½ inches x (width) 9½ inches.

**Net Weight:** 22¾ pounds with battery; 17¼ pounds without battery.

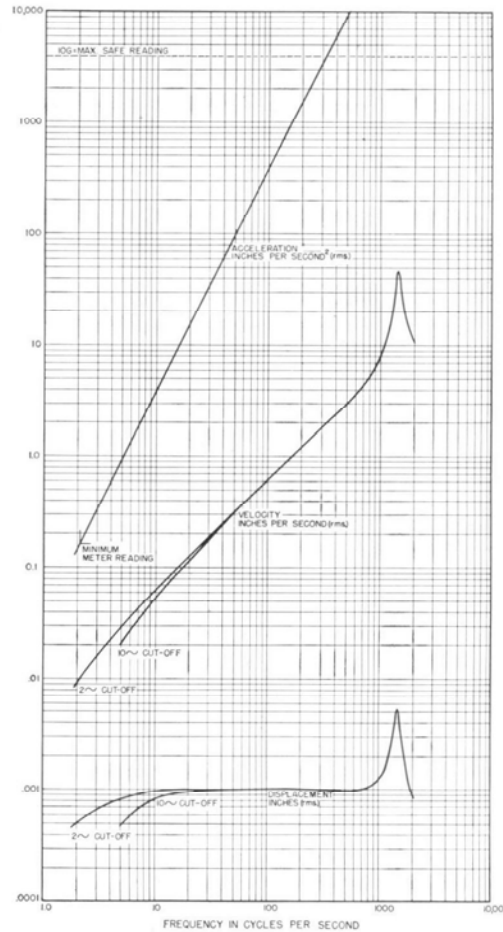

Readings of the Vibration Meter as a function of frequency for a constant displacement of 0.001 inch (rms).

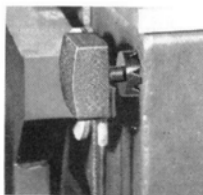

Vibration pickup held in place by the TYPE MAP-2-S1 Permanent-Magnet Clamp.

Type	Code Word	Price
<b>761-A</b>   <b>Vibration Meter</b> .....	VIRUS	<b>\$490.00</b>
<b>761-P1</b>   <b>Replacement Pickup</b> * .....	NOSEY	<b>40.00</b>
<b>Replacement Battery for above</b> .....	VIRUSADBAT	<b>6.25</b>
<b>MAP-2-S1</b>   <b>Permanent-Magnet Clamp</b> .....	MAGNO	<b>7.50</b>

\* Give instrument serial number when ordering.

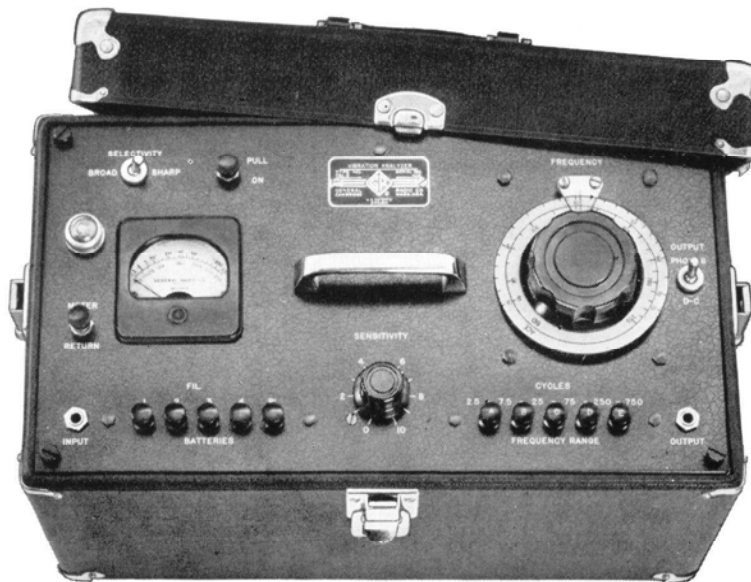

### TYPE 762-B VIBRATION ANALYZER

**USES:** The TYPE 762-B Vibration Analyzer makes possible the analysis of vibration phenomena having fundamental frequencies as low as 2.5 cycles per second. It is intended primarily for use with the TYPE 761-A Vibration Meter but can also be used for general harmonic analysis of very-low-frequency voltages in the laboratory.

Its range includes practically all frequencies normally encountered in vibration studies, from the fundamental vibrations of ships and other large structures to the unbalance vibrations of high-speed centrifuges.

**DESCRIPTION:** The analyzer is similar in all essential characteristics of performance, construction, operation, and appearance to the TYPE 760-B Sound Analyzer (page 186) except that the frequency has been lowered by a factor of 10, the output meter has a single logarithmic range, and provision has been made for operation with broad selectivity if desired. The latter arrangement is particularly useful in identifying components in the two lowest frequency ranges (2.5 to 25 cycles per second) and in making analyses involving components that vary slightly about a mean frequency.

#### SPECIFICATIONS

**Frequency Range:** 2.5 to 750 cycles, covered in five ranges as follows: 2.5 to 7.5, 7.5 to 25, 25 to 75, 75 to 250, 250 to 750.

**Band Width:** For the sharp selectivity position, the relative attenuation is approximately 30% (3 db) at a frequency differing by 1% from that to which the analyzer is tuned. For the broad selectivity position, the attenuation is at least 30% for a frequency difference of 5%. At one octave from the peak, the relative attenuations are at least 98% (35 db) and 90% (20 db), respectively.

**Frequency Calibration:** Sharp selectivity network,  $\pm 1\frac{1}{2}\%$  or  $\pm 1\frac{1}{2}$  cycles, whichever is the larger, over the three highest ranges (25 to 750 cycles); on the two lower ranges (2.5 to 25 cycles), the accuracy is  $\pm 5\%$  or  $\pm 0.2$

cycle, whichever is the larger. The frequency as determined with the broad selectivity network deviates on the average by less than  $\pm 2\%$  from that determined with the sharp selectivity network.

**Frequency Response:** The response of the sharp selectivity network is flat within  $\pm 2$  db over the entire range. At points where two ranges overlap, the sensitivity is the same on either range within  $\pm 1$  db. The sensitivity of the broad selectivity network is the same as that of the sharp selectivity network within  $\pm 2$  db.

**Tube Complement:** Three 1L4, one 1S5, and one neon lamp (NE-48).

**Net Weight:** 34 $\frac{1}{4}$  pounds, with batteries; 27 $\frac{1}{2}$  pounds, without batteries.

For other specifications see TYPE 760-B, page 186.

Type	Code Word	Price
762-B   Vibration Analyzer.....	AWARD	\$585.00

PATENT NOTICE. See Note 14 page viii.

# STROBOSCOPES

The STROBOSCOPE permits rotating or reciprocating objects to be viewed intermittently and produces the optical effect of slowing down or stopping motion. For instance, an electric fan revolving at 1800 rpm will apparently be stationary if viewed under a light that flashes uniformly 1800 times per minute. At 1799 flashes per minute, the fan will appear to rotate at 1 rpm, and, at 1801 flashes, it will appear to rotate backward at 1 rpm. Because the human eye retains images for an appreciable fraction of a second, no flicker is seen except at very low speeds. The apparent slow motion is an exact replica of the original higher-speed motion, so that the motion of a high-speed machine can be analyzed under normal operating conditions.

When the flashing rate of the light is adjustable, the control can be calibrated in flashes (or revolutions) per minute. The stationary image that is seen when the flashing rate of the lamp and the rotational rate of a shaft are equal permits very precise speed measurements to be made.

General Radio stroboscopes are electronic-flash devices, in which the flash duration is very short, of the order of a few millionths of a second, which allows very rapid motion to be arrested.

The STROBOTAC<sup>®</sup> is a compact, portable, stroboscopic tachometer that operates from the a-c power line, and is capable of speed measurements to better than 1%. It is equally useful for slow motion studies. Because there is no mechanical connection between tachometer and machine, no power is absorbed by the tachometer. Therefore, speed measurements can be made on very low-power mechanisms and on production equipment such as spindles on a textile spinning frame, motors, and other machines. With the STROBOTAC, a number of such machines can be checked for uniform and correct speed, nearly as easily as one can aim an ordinary flashlight.

For applications where a brighter light is desired, the STROBOLUX<sup>®</sup> can be added. Its flashing rate is controlled by the STROBOTAC. Another auxiliary light source, the STROBOLUME, emits a very-high-intensity flash that is particularly useful for viewing low-speed machines, such as looms and printing presses. The STROBOLUME has sufficient brilliance for use in high-speed photography.

The Contactor is a device for attachment to a rotating shaft to flash a stroboscope once for each revolution. The Contactor permits absolute synchronism with a shaft which may be constantly varying in speed. A phasing control is provided to permit flashing of the light at any point in the 360° rotation of the shaft.

The MICROFLASH is an ultra-high-speed light source for single-flash photography of rapidly moving objects, such as bullets or the spray pattern of fuel injection nozzles.

The TYPE 651-AH Recorder (page 228) can be used in conjunction with a stroboscope to produce a photographic record of high-speed phenomena, particularly of transient motion, where the lack of a uniform repetition rate precludes the use of visual methods.

## POLARISCOPE

Use of the high-intensity STROBOLUME light source with a polariscope makes possible dynamic measurement of strain in photoelastic models. The General Radio Polariscope, designed particularly for this use, is also an inexpensive, portable device for static measurements, since photographic exposure times of only a few millionths of a second do not demand the heavy, vibration-free mounting of a conventional polariscope. The large, 8-inch field permits easy viewing of either isoclinic or isochromatic patterns. Substantially monochromatic illumination is obtained from the STROBOLUME's blue-rich spectrum through the use of a standard photographic filter.

The characteristics of the light output from General Radio Stroboscopes are tabulated below:

<i>Instrument</i>	<i>Flashes per Second</i>	<i>Peak Light * Mega candlepower</i>	<i>Flash Duration ** Microseconds</i>	<i>Beam Horizontal *** Candlepower seconds</i>	<i>Page</i>
Strobotac	50 to 240	0.02	10	0.2	192
	10 to 60	0.03	40	1.2	
Strobolux	10 to 100	.2	15	3.0	193
	1 to 60	.35	24	8.4	
	Single Flash	1.8	42	75.5	
Strobolume	10 to 50	0.14	10	1.4	194
	0 to 10	10	30	300	
Microflash	Single Flash	50	2	100	196

\* Approximate value for lowest frequency shown.  
\*\* Approximate value based 1/2 peak light value.

\*\*\* Product of previous two columns.  
Contactor — see page 198.  
Polariscope — see page 197.



## TYPE 631-BL STROBOTAC®

**STROBOSCOPIC TACHOMETER  
ACCURATE TO  $\pm 1\%$   
FOR SPEED MEASUREMENT AND  
SLOW-MOTION STUDIES**

**USES:** Wherever machines operate, there are uses for the STROBOTAC — in the design laboratory, in production maintenance, and in the repair shop. Use it:

— for the slow-motion observation of

Cams	Gears	Pawls
Pulleys	Fans	Sprockets
Governors	Linkages	Chains

and other machine elements

— for the rapid alignment of close-tolerance mechanisms in production

— for calibrating tachometers in aircraft

— for measuring the speed of

Motors

Production machines, such as textile spindles

Small, low-power devices

Machines in underload and overload tests

Any repetitive motion that can be seen, even if mechanically inaccessible

**DESCRIPTION:** The STROBOTAC includes, in one compact unit, a strobotron lamp in a parabolic reflector, an electronic pulse generator to control the flashing rate, and a power supply operating from the a-c power line. The flashing rate is adjusted by a large knob (see photo), and the corresponding speed in rpm is indicated on an illuminated drum dial on the top face of the unit. The flashing rate can also be controlled from an external generator or contactor, or from the a-c power line.

The normal speed range is from 600 to 14,400 rpm. An additional low range extends down to 60 rpm. Speeds above 14,400 can be



measured by using flashing rates that are simple submultiples of the speed to be measured.

At speeds of 600 rpm and below, flicker becomes pronounced, because the human eye cannot retain successive images long enough to create the illusion of continuous motion. This flicker, and the low average level of illumination, set 600 rpm as the lower limit of speeds for which the STROBOTAC is recommended for slow-motion studies. For lower speeds, use the STROBOTAC to flash the STROBOLUME, page 194, which produces a high-intensity flash.

For more light at speeds above 600 rpm, use the STROBOLUX.

**FEATURES:** ➤ Small, compact.

➤ Short flash — gives sharp images.

➤ High accuracy.

➤ Requires no contact with machine — absorbs no power.

➤ Easy to set — easy to read.

### SPECIFICATIONS

**Range:** 600 to 14,400 rpm on dial in two ranges, 600 to 3600 rpm and 3600 to 14,400 rpm; useful at speeds up to 100,000 rpm. Additional low range of 60 to 1440 rpm ( $\frac{1}{10}$  scale values) for flashing STROBOLUME.

**Accuracy:**  $\pm 1\%$  of scale reading above 900 rpm on normal (600 to 14,400) range when scale is standardized in terms of a frequency-controlled power line.

**Flash Duration:** 10 to 40 microseconds.

**Peak Light:** 0.02 to 0.03 megacandlepower.

**Power Supply:** Type 631-BL, 105 to 125 volts, 60 cycles.

50-cycle models are available as listed below. Prices quoted on request for other voltages and frequencies.

**Power Input:** 35 watts, maximum.

**Tube Complement:** One TYPE 631-P1 Strobotron, one 6X5-GT/G, and one 6N7-GT/G.

**Accessories Supplied:** TYPE CAP-35 seven-foot power cord, plug to fit contactor jack, spare fuses.

**Mounting:** Metal cabinet with handle.

**Dimensions:**  $7\frac{5}{8}$  x 9 x 10 inches, over-all; lens dia., 5 inches.

**Net Weight:**  $9\frac{1}{2}$  pounds.

Type	Power Supply	Code Word	Price
631-BL	Strobotac® 115 volts, 60 cycles.....	BRUIN	\$155.00
631-BLS3	Strobotac® 115 volts, 50 cycles.....	BRUINPASHA	170.00
631-BLS8	Strobotac® 230 volts, 50 cycles.....	BRUINREGAL	170.00
631-P1	Replacement Strobotron.....	SENNA	8.00

PATENT NOTICE. See Note 6, page viii.



## TYPE 648-A STROBOLUX®

### AUXILIARY LIGHT SOURCE

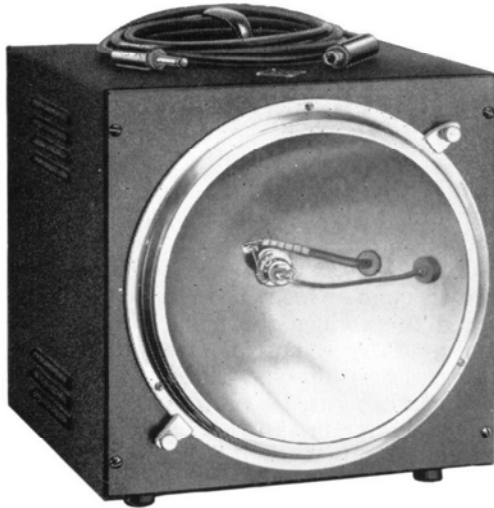

**USES:** The STROBOLUX is a white-light source for use with the STROBOTAC in applications where the areas to be illuminated are larger than the STROBOTAC can cover, or where greater light

intensity is required. Although its flash is not so short as that of the MICROFLASH (page 196), it can be used as a light source for single-flash photography.

**DESCRIPTION:** TYPE 648-A STROBOLUX consists of a power supply and lamp, capable of producing brilliant light flashes at speeds up to 6000 per minute. The triggering source is a STROBOTAC, which can be externally controlled if desired.

The lamp furnishes a brilliant white light whose intensity is between ten and one hundred times that of the STROBOTAC.

### SPECIFICATIONS

**Range:** From single flashes to 6000 per minute.

**Duration of Flash:** Between 15 and 50 microseconds, depending upon flashing speed and the setting of the SPEEDS range switch. The shorter flash is obtained at the higher speeds.

**Peak Light:** 1.8 megacandlepower at single flash; 0.2 Mep at 6000 flashes per minute.

**Guide Number:** The guide number (distance in feet x aperture) for single flash photography is approximately 20 with a film speed of 100 (ASA).

**Power Supply:** 105 to 125 (or 210 to 250 volts), 50 to 60 cycles.

**Power Input:** 125 watts, maximum.

**Tube Complement:** One 5Z3 Rectifier and one Type 648-P1 Lamp.

**Mounting:** Sheet-metal case with black wrinkle finish. Lamp and its 9-inch reflector are mounted in one side of case, the power supply in the other. The removable lamp assembly has a  $\frac{1}{4}$  x 20 tripod thread and connects to power supply through a 9-foot cable.

**Accessories Required:** A STROBOTAC is necessary to operate the STROBOLUX.

**Accessories Supplied:** TYPE CAP-35 seven-foot power cord, cable for STROBOTAC connection, spare fuses.

**Dimensions:**  $13\frac{3}{4}$  x  $11\frac{5}{8}$  x  $13\frac{1}{4}$  inches, over-all; lens diameter,  $8\frac{1}{4}$  inches.

**Net Weight:**  $31\frac{3}{4}$  pounds.

Type		Code Word	Price
648-A	Strobolux®	SCALY	\$235.00
648-P1	Replacement Lamp	SURLY	18.50

PATENT NOTICE. See Note 6, page viii.

Light and compact, the STROBOTAC is easily held in one hand, while the flashing rate is adjusted by the other hand.

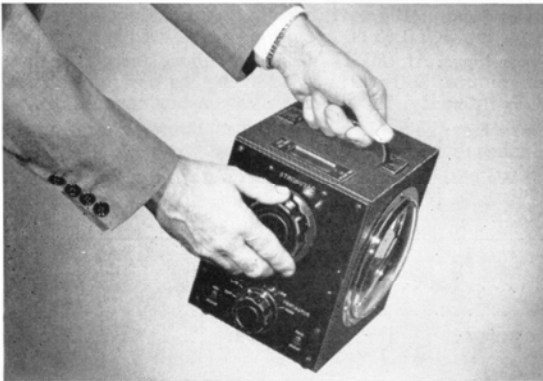

View of STROBOLUX and STROBOTAC. Cable for interconnections is furnished. STROBOLUX lamp is removable for use at end of a nine-foot cable.





**USES:** The STROBOLUME produces a brilliant, white, light flash that is well suited for studying motions of machines operating at relatively low speeds. Two important applications are the analysis and adjustment of shuttle motion in textile looms and of color register in printing.

The STROBOLUME is designed to be flashed from an external contactor, such as the TYPE 1535-B (page 195), and hence is particularly useful where the motion to be examined is related to angular position of a shaft, such as a crankshaft, camshaft, or countershaft, on one end of which a contactor is held or clamped. It can also be flashed from a STROBOTAC. It is adaptable as a light source for single- and multiple-flash photography in research projects, where the motion of the subject is often too fast to be stopped by conventional "speedlights."

## TYPE 1532-B STROBOLUME

### HIGH-INTENSITY LIGHT SOURCE

**DESCRIPTION:** The elements of the STROBOLUME are a high-voltage transformer and rectifier; a capacitor, which is charged to about 2500 volts from the rectifier; and a lamp through which the capacitor is discharged to produce the flash. The discharge is initiated by a special strobotron tripped by an external impulse. Either of two values of capacitance can be used, as selected by a switch. The larger is for flashing rates up to 1200 per minute with intense light for short periods, the smaller for rates up to 3000 with about 1/20th as much light. The entire assembly is mounted in a small metal case with handle.

**FEATURES:** ➤ Brilliant, high-intensity, short white flash.

- Overload breaker prevents overheating.
- Compact, light, portable assembly.
- Lamp assembly is removable and has a 14-foot extension cable.
- Lamp housing has tripod thread.
- Long-life sealed-beam lamp easily replaced.

### SPECIFICATIONS

**Flashing Speed Range:** High intensity — continuous, 60 flashes per minute, maximum; intermittent, or for short periods, up to 1200 per minute. Low intensity — continuous up to approximately 3000 per minute.

**Peak Light:** 10 megacandlepower at 60 flashes per minute; 0.14 mep at 3000 fpm.

**Duration of Flash:** Approximately 30 microseconds with intensity switch at HIGH; approximately 10 microseconds with switch at LOW.

**Guide Number:** The guide number (distance in feet x aperture) for HIGH intensity is approximately 100 with fast film speed of 100 (ASA).

**Flashing Control:** TYPE 1535-B Contactor or TYPE 631-BL Strobotac with TYPE 1532-P2 Transformer Cable.

**Tube Complement:**

- 1 Rectifier — TYPE 816
- 1 Strobotron — TYPE 0A5
- 1 Flash Lamp — TYPE 1532-P1 (GE Type FT-220)

**Accessories Supplied:** Power cord with ground terminal, flash control cord with push button, and a plug to which a contactor can be connected.

**Other Accessories Required:** None, if lamp is to be flashed manually by push button. For stroboscopic work, a TYPE 1535-B Contactor, or a TYPE 631-BL STROBOTAC with TYPE 1532-P2 Transformer Cable is needed.

**Mounting:** Metal case; lamp is removable; storage space for lamp cable is provided in case. Lamp housing has tripod socket with  $\frac{1}{4}$  x 20 thread.

**Power Supply:** 105 to 125 volts, 50 to 60 cycles or 210 to 230 volts, 50 to 60 cycles; see price list below.

**Power Input:** At HIGH intensity, 105 watts at 60 flashes per minute; 500 watts at 1200 flashes per minute. At LOW intensity, 120 watts at 300 flashes per minute.

**Dimensions:** 13 x 7 $\frac{1}{2}$  x 11 $\frac{1}{2}$  inches, over-all; lamp unit, 6 inches diameter x 5 $\frac{3}{4}$  inches.

**Net Weight:** 18 $\frac{1}{2}$  pounds. Lamp unit, only, 2 pounds.

Type		Code Word	Price
1532-B	Strobolume, 115 volts, 50 to 60 cycles.....	TITLE	\$265.00
1532-P1	Replacement Lamp.....	TOWEL	22.00
1532-P2	Transformer-Cable (Length: 7 feet).....	TULIP	13.00
1532-BQ18	Strobolume, 230 volts, 50 to 60 cycles.....	TITLEREPHEL	290.00

PATENT NOTICE. See Note 6, page viii.



## TYPE 1535-B CONTACTOR

**USES:** The TYPE 1535-B Contactor is a control and coupling device for synchronizing a stroboscope with a rotating shaft, so that motion can be observed as a function of shaft angle. It is particularly useful in the examination of relatively low-speed machinery with the TYPE 1532-B STROBOLUME, in such applications as the timing of loom shuttles and the adjustment of register in printing. It can be used equally well with the STROBOTAC or with the combination of STROBOTAC and STROBOLUX, at speeds up to 5000 rpm.

**DESCRIPTION:** The elements of the contactor are the electrical contacts, the phasing system, and the mechanical coupling system.

The electrical contact system comprises an accurately rotating cam and a low-inertia breaker arm. One contact is made for each revolution of the drive shaft.

The phase-adjusting system permits a 360-degree adjustment of the contacts with respect to the rotating shaft. The relative position of the contacts is shown on a scale graduated in 5-degree intervals. The scale can be set to zero with no change in the contact setting. This is particularly useful for making timing studies. Two phasing adjustments are provided; one is located on the contactor body, and the other is at the end of a detachable ten-foot flexible shaft.

The mechanical coupling system consists of an 18-inch flexible shaft, whose free end terminates in a powerful, multipole, Alnico magnet with spring-loaded centering device, which assures positive drive from a centered steel or iron shaft without need for drilling and tapping the shaft.

The entire assembly is mounted on a sturdy four-foot rod secured in a sturdy, cast-iron base, 18 inches in diameter. The contactor may be located at any point on this rod and is locked in position by a thumbscrew.

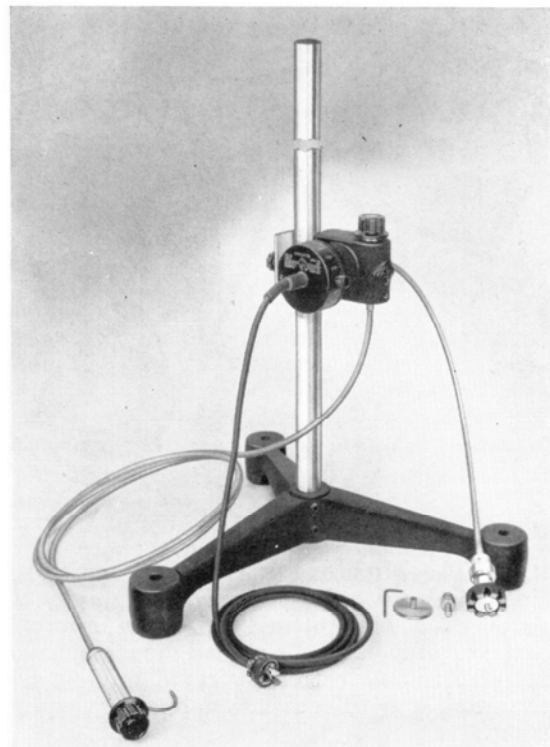

- FEATURES:**
- Can be easily attached and removed from machine while in motion.
  - Remote phase-control shaft is removable.
  - Ball bearings are used on rotating parts.
  - Flexible drive coupling shaft can be bent through 90° angle for work in crowded locations.
  - Auxiliary coupling devices are furnished for permanent coupling to shaft, or where shaft is non-magnetic.
  - Contactor can be removed from stand and mounted permanently on machine.

### SPECIFICATIONS

- Speed Range:** 0 to 5000 rpm.
- Contacts per Revolution:** One
- Range of Phase Adjustment:** 360°
- Range of Height Adjustment:** 6 inches to 4 feet
- Diameter of Base:** 18 inches
- Accessories Supplied:** Auxiliary coupling devices for connection to shaft in which hole has been drilled.
- Other Accessories Required:** When the contactor is used with a STROBOTAC, the TYPE 1535-P1 Adaptor Cable is needed for connection to the STROBOTAC.
- Net Weight:** 19¾ pounds.

Type	Code Word	Price
1535-B	CROCK	\$140.00
1535-P1	CROCKCABLE	6.00
Contactor.....		
Adaptor Cable.....		

PATENT NOTICE. See Note 6, page viii.



**TYPE 1530-A  
MICROFLASH  
LIGHT SOURCE  
FOR ULTRA-SPEED  
FLASH PHOTOGRAPHY**

**USES:** The MICROFLASH is a light source for single-flash, ultra-high speed photography. It produces a high-intensity flash of approximately 2 millionths of a second duration, capable of arresting extremely rapid motion and recording it with conventional camera equipment.

The MICROFLASH finds many applications in engineering and the physical sciences, particularly in such fields as ballistics, hydraulics, kinematics, and industrial chemistry. Among these are studies of wear or abrasion, of turbulence in fluids, of fractures in solids, of mechanical distortion at high rotational speeds, and of the atomization of liquid fuels.

**DESCRIPTION:** The elements of the MICROFLASH are a power supply, a gas-filled lamp, and a trigger circuit. A high-voltage transformer and rectifier, operating from the a-c

power line, charge a capacitor across the lamp terminals. An electrical impulse, which may be derived in any one of several ways from the phenomenon to be photographed, ionizes the gas in the lamp, and the energy stored in the capacitor is dissipated in a discharge through the lamp, producing a short brilliant flash. A minimum of 10 seconds is required between flashes for the capacitor to become fully charged.

The trigger circuit includes an amplifier, so that the flash can be tripped with a conventional crystal microphone, if desired. The flash can also be triggered by either a make or a break contact.

**FEATURES:** The outstanding feature of the MICROFLASH is its high-intensity, very short flash. During the flash, an object moving at 1000 feet per second is displaced only about two hundredths of an inch. Consequently, sharp records can be obtained of bullets and other projectiles in flight.

### SPECIFICATIONS

**Duration of Flash:** Approximately 2 microseconds.

**Peak Light:** 50 megacandlepower.

**Guide Number:** The guide number (Distance in feet x aperture) for the MICROFLASH is approximately 20 with film speed of ASA 100, and with the subject several feet from the lamp.

**Temperature and Humidity Effects:** Temperature and humidity variations (32 to 100° F, 0 to 95% R.H.) have no appreciable effect upon the operation of the instrument.

**Power Supply:** 105 to 125 (or 210 to 250) volts, 50 to 60 cycles.

**Power Input:** 70 watts.

**Tube Complement:**

1 — 5U4-G  
1 — 2V3-G  
1 — FG-17 (GE)  
1 — 6AC7/1852

1 — TYPE 1530-P1 (General Radio)

**Accessories Supplied:** Microphone with cable, tripod, 2 spare TYPE 1530-P1 flash lamps, plug for connection to contactor-trip jack, power cable, and spare fuses.

**Mounting:** The power supply and trigger circuits are assembled in one metal case, the lamp in another. The two cases lock together for transportation, completely protecting the lamp and controls.

**Dimensions:** 25 $\frac{1}{8}$  x 13 $\frac{1}{4}$  x 11 $\frac{3}{4}$  inches, over-all; lens diameter, 8 $\frac{1}{4}$  inches.

**Net Weight:** 72 pounds.

Type		Code Word	Price
1530-A	Microflash.....	TAFFY	\$650.00
1530-P1	Replacement Flash Lamp.....	TONIC	24.00

PATENT NOTICE. See Note 6, page viii.





## TYPE 1534-A POLARISCOPE FOR DYNAMIC AND STATIC STRESS ANALYSIS

**USES:** The General Radio Polariscope is used in the study of static and dynamic stresses in transparent, photoelastic models of structural members by means of the fringe patterns that they exhibit under polarized light when stressed. It is best adapted to the study of two-dimensional stresses such as are set up by tension, compression, and bending in members of uniform thickness, viewed normal to the stressed axis. Because the photographic exposure time is extremely short, it can be used for dynamic as well as static observations. It is suitable for the study of both isoclinic and isochromatic patterns.

The Polariscope has many applications in physics and mechanical engineering, among them the study of the effects of fillets and other stress-relieving contours.

**DESCRIPTION:** The view below shows the elements of the TYPE 1534-A Polariscope. The incandescent lamp unit shown is used for adjustment and focussing and is supplied with the polariscope. For photographing the stress patterns, this lamp is replaced by a STROBOLUME (see price list page 194), which emits a brilliant flash of approximately daylight quality, lasting not more than 30 microseconds (30 millionths of a second), so that dynamic patterns can be arrested for photographing. The Polariscope with the STROBOLUME lamp is shown on the next page.

The blue richness of the STROBOLUME spectrum permits the use of a filter, peaked in the blue-green at 4800 Angstroms, to give essentially monochromatic light.

The polarizer and analyzer assemblies are identical, each mounting a plane polarizer with a degree scale calibrated from zero to both plus and minus 90° for isoclinic (loci of equi-directional stresses) determination. A quarter-wave retardation plate, removable without tools, rotatable, and registering for right- or left-hand circular polarization, permits isochromatic (loci of equal net intensity stresses) patterns to be observed. Optical field is 8 inches in diameter.

All elements are horizontally adjustable along the 36-inch shafts and vertically adjustable over about 12 inches. Vee and flat ways insure optical alignment. Thumbscrews hold desired settings. Bases of all components are provided with mounting holes for use when the shafts are not required.

The Straining Bridge furnished with the instrument will serve for simple set-ups, but is not intended to be an accurately calibrated straining frame. Such equipment can be devised by the user to fit his particular requirements. Similarly, for dynamic stress analysis, both the straining means and the flash-tripping circuits should be tailored for the job by the user.

View of complete Polariscope with incandescent light source and camera.

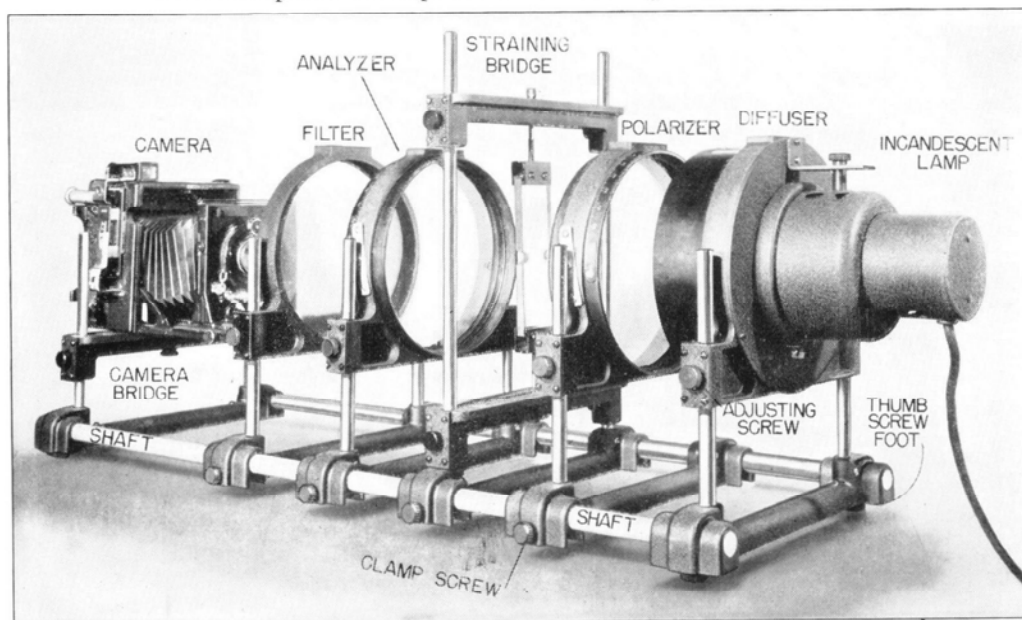



- FEATURES:**
- Light weight and low cost, resulting from the use of a high-speed flash and its consequent elimination of long photographic exposure requirements.
  - High photoelastic sensitivity, resulting from use of light of very short wavelength.
  - Photographic records can be made without darkening the room.
  - Can be used in drafting room as easily as in laboratory.

- Convenient and simple to use.
- Large, 8-inch optical field.
- Uses conventional camera equipment;  $f/4.5$  aperture with slow film is adequate.
- Dynamic stresses can be studied.
- Brings photoelastic measurements within reach of the laboratory with a modest budget and limited space.

**SPECIFICATIONS**

**Components Supplied:**

- 1 TYPE 1534-P1 Polarizer
- 1 TYPE 1534-P1 Analyzer
- 1 TYPE 1534-P2 Diffuser
- 1 TYPE 1534-P3 Strain Bridge
- 1 TYPE 1534-P4 Camera Bridge
- 1 TYPE 1534-P5 Filter
- 1 TYPE 1534-P6 Incandescent Light Source
- 2 TYPE 1534-P7 Shafts (36 inches long)

**Optical Field:** 8-inch diameter.

**Vertical Adjustment:** 12 inches.

**Accessories Required:** TYPE 1532-B Strobolume, camera with ground glass and lens of  $f/4.5$  or faster. Camera Bridge has captive  $1/4$ -20 thumbscrew to fit tripod socket on camera.

**Other Accessories Recommended:** Wratten No. 75 front-of-lens filter. Permits camera shutter to be opened for short periods in artificial light without danger of fogging.

**Film:** Process film is recommended for optimum results.

**Model Material:** CR-39 Columbia Resin is recommended. Models contour-cut from sheets cast between plate glass surfaces require no further finishing.

**Dimensions:** 36 x 14½ x 18 inches, over-all.

**Net Weight:** 32 pounds.

Light- and dark-field photographs of specimen, illustrating fringe patterns shown under circular polarization.

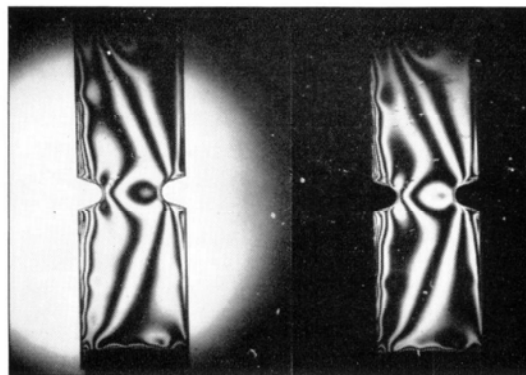

Type		Code Word	Price
1534-A	Polariscope.....	FOCUS	\$490.00
	<b>Bulletin with complete description mailed on request.</b>		
1532-B	Strobolume.....	TITLE	\$265.00

PATENT NOTICE. See Note 6, page viii.

View of Polariscope with Strobolume flash source.

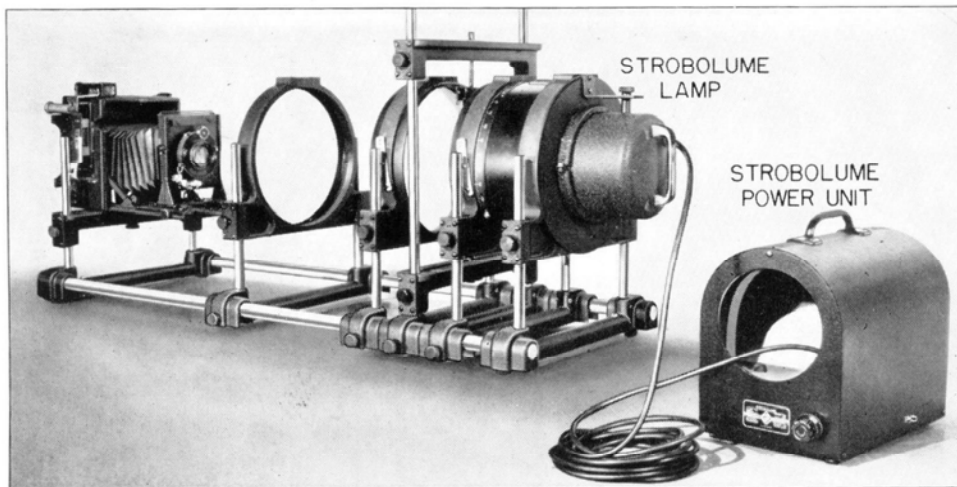

# SWEEP DRIVES

Automatic data display is becoming of great importance in instrumentation as the need for more data in less time demands greater efficiency in the use of manpower and time. *The devices described in this section are mechanical accessories for already existing instruments that will convert them to automatic operation.* Good quality, manually adjustable instruments of most kinds can be easily adapted for automatic display work. The vastly improved efficiency of the converted instrument will pay for the conversion many times over.

The most flexible of these is the TYPE 1750-A Sweep Drive. Adjustable over a wide range of angular displacement and speed, this device can be attached to a knob, dial, or shaft to operate as a robot hand that will turn the shaft back and forth in a prescribed manner. Equipped with an internal potentiometer that is ganged to the output shaft, this sweep drive supplies a d-c voltage, proportional to angle, that serves as a position indicator.

The TYPE 907-R and 908-R X-Y Dial Drives can be used to perform this same function at lower cost but with less flexibility. Driven by synchronous motors, they are restricted to one speed. The low-speed models are designed for only one traverse without resetting and do not reverse.

The TYPE 908-P1 and 908-P2 Synchronous Dial Drives are extremely simple drives. To achieve the lowest possible cost, consistent with utility, they depend upon the known constant-speed characteristic of the synchron-

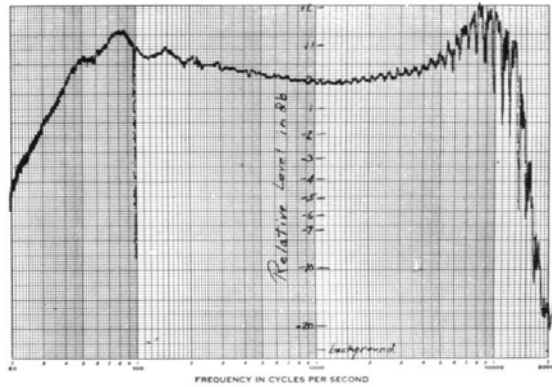

Graphic records of the frequency response of a tape recorder. Source was a TYPE 1304-B Beat-Frequency Audio Generator, driven by a TYPE 908-R96 X-Y Dial Drive. The vertical line at 100 cycles is the frequency calibration reference.

ous motor to supply position information. They can be set to cover different angles of dial rotation, and they reverse automatically to yield an oscillating motion.

The TYPE 874-MD is a motor drive specifically designed to attach to the TYPE 874-LBA Slotted Line. This drive can be set to provide reciprocating traverse over a wide range of horizontal displacements at continuously adjustable speeds. Like the TYPE 1750-A Sweep Drive it provides position information from a d-c voltage developed across a potentiometer ganged to probe carriage.

An essential characteristic of sweep oscillators, in particular, is constancy of output with frequency. The TYPE 1263-A Amplitude-Regulating Power Supply, when used with General Radio Unit Oscillators, provides a means of maintaining constant output. It operates in a feedback loop, comparing the d-c voltage obtained from a rectifier in the oscillator output with a reference potential and using the resultant signal to control the oscillator plate-supply voltage.

To supply both horizontal and vertical information for cathode-ray display of signals between 200c and 500kc, the TYPE 1210-P1 Detector and Discriminator is designed for use with the TYPE 1210-B Unit R-C Oscillator. Both the detector and discriminator time constants are matched to minimize pattern phase shifts at the sweep speed of the TYPE 908-P2 Synchronous Dial Drive.

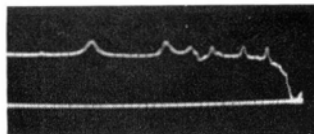
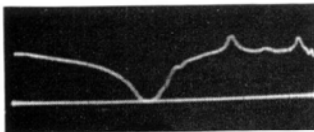

Oscillograms of the frequency characteristic of a TYPE 874-FR Rejection Filter tuned to 76 Mc. Sweep range is 48 to 250 Mc (upper) and 250 to 900 Mc (lower). Oscillator is driven by the TYPE 1750-A Sweep Drive; input amplitude is held constant by the TYPE 1263-A Amplitude-Regulating Power Supply. Vertical scale is square-law.

Type		See Page
1750-A	Sweep Drive.....	200
908-R	X-Y Dial Drives.....	203
908-P	Synchronous Dial Drives.....	202
1263-A	Amplitude Regulating Power Supply.....	148
874-MD	Slotted-Line Motor Drive.....	48
1210-P1	Detector and Discriminator.....	115



## TYPE 1750-A SWEEP DRIVE

FOR WIDE-RANGE

AUTOMATIC

DATA DISPLAY



**USES:** Measurements by sweep methods over wide frequency ranges are made possible and practical with the TYPE 1750-A Sweep Drive, which adapts manually-operated equipment to sweep operation. It can be used in the display of any electrical quantity as a function of the shaft angle of the device being swept and can be adjusted to sweep in reciprocating motion any arc up to 300 degrees, at speeds up to 5 per second. Its universal coupler attaches easily to any knob, dial, or shaft. Used in conjunction with Unit Oscillators (see page 204), it makes available an extremely versatile system of swept signal sources covering a frequency span from 0.5 Mc to 2000 Mc. Because of their wide frequency coverage, only four Unit Oscillators are required for this span: TYPE 1211-B, 0.5 to 50 Mc; TYPE 1215-B, 50 to 250 Mc; TYPE 1209-B 250 to 920 Mc; TYPE 1218-A, 900 to 2000 Mc. For a constant output over the entire frequency range of any one of these four Unit Oscillators, the TYPE 1263-A Amplitude

Regulating Power Supply is used. (See page 148). Provision is made in the Sweep Drive for the generation of deflection voltages for a cathode-ray oscilloscope, to present visual displays of circuit characteristics.

**DESCRIPTION:** The Sweep Drive is powered by a small motor, which drives the output shaft through an adjustable rack and a differential. Sweep frequency is determined by the motor speed, sweep arc is determined by the adjustable rack, and sweep center position is controlled through the differential. All adjustments can be made while the drive is in motion. An adjustable limit switch can be set to stop the drive when predetermined limits of motion of the driven shaft are exceeded. The limits can be set up to nine full turns of the driven shaft. Any 300-degree of the nine-turn range can be swept at one setting of the sweep-arc control. Other 300-degree arcs may be swept by varying the center position control.

An oscilloscope-deflection-voltage circuit

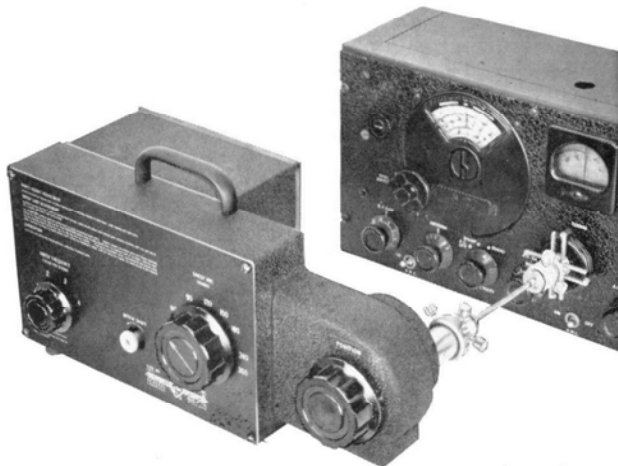

The sweep drive attached to the tuning knob of a short-wave receiver.

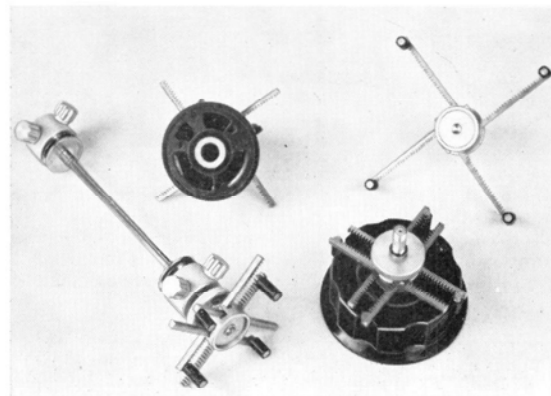

View of the coupling attachments furnished with the Sweep Drive. At left is the coupling shaft, to which has been attached the universal clutch. The other views show the clutch and the clutch attached to a knob.



provides a horizontal deflection voltage that is proportional to shaft angle. A blanking circuit is included to eliminate the oscilloscope return trace, and produce a base line for oscilloscope display.

- FEATURES:** ➤ Adapts manually operated equipment for automatic data presentation.
- Can be attached to any dial, shaft, or knob.
  - Three dials adjust sweep speed, sweep arc, sweep center while the drive is in motion.

- Generates horizontal deflection voltage proportional to shaft angle for oscilloscope displays.
- Adjustable limit switches protect against accidentally exceeding pre-set limits of shaft travel.
- Provides constant-output swept oscillators when used with a TYPE 1263-A Amplitude Regulating Power Supply.
- Brings sweep techniques to the laboratory or production line at minimum cost.

**SPECIFICATIONS**

**Reciprocating Output Shaft:**  
 Center Position: Adjustable over 9-turn range.  
 Sweep Arc: Adjustable 30-300 degrees.  
 Torque: Rated max. 24 ounce-inches.  
 Sweep Speed: Adjustable 0.5-5 cycles per second. Moment of inertia limits the speed at which a load can be driven.  
 Height of Shaft: Adjustable from 2½-4⅞ inches over bench.  
 Flexible Coupling: 5¾ inches long.  
 Provision for Coupling: Shaft diameters, ¼ and ⅜

inches; knobs and dials, 1 to 4 inches. Continuously adjustable.  
**Limit Switch:** Adjustable within 9 turns.  
**Sweep Voltage:** 2.5 volts peak to peak, ungrounded.  
**Blanking:** Shorting contact closed during clockwise rotation of driven shaft, ungrounded.  
**Accessories Supplied:** Couplings, tube of lubricant, spare fuses.  
**Input Power:** 115 volts, 50-60 cycles, 60 watts maximum.  
**Dimensions:** 17½" wide, 9" high, 8¼" deep.  
**Weight:** 22½ pounds.

Type		Code Word	Price
<b>1750-A</b>	<b>Sweep Drive (115 volts, 50-60 cycles)</b> .....	STUDY	<b>\$440.00</b>
<b>1750-AQ18</b>	<b>Sweep Drive (230 volts, 50-60 cycles)</b> .....	STUDYREPEL	<b>475.00</b>

For a complete sweep system, add the following:

Type		Page
<b>1263-A</b>	<b>Amplitude-Regulating Power Supply</b> .....	<b>148</b>
<b>874-VR</b>	<b>Voltmeter Rectifier</b> .....	<b>49</b>
<b>274-NF</b>	<b>Patch Cord</b> .....	<b>242</b>
<b>874-Q6</b>	<b>Adaptor</b> .....	<b>242</b>
<b>874-VQ</b>	<b>Voltmeter Detector*</b> .....	<b>49</b>
<b>874-WM</b>	<b>50-ohm Termination*</b> .....	<b>55</b>

\* Used when 50-ohm systems are measured, to rectify the output of the network under test and to provide vertical deflection voltage.

TYPE 1750-A Sweep Drive and the TYPE 1263-A Amplitude Regulating Power Supply set up to sweep a TYPE 1209-B Unit Oscillator, thus providing a constant sweep output over a frequency span of 250 Mc to 920 Mc.

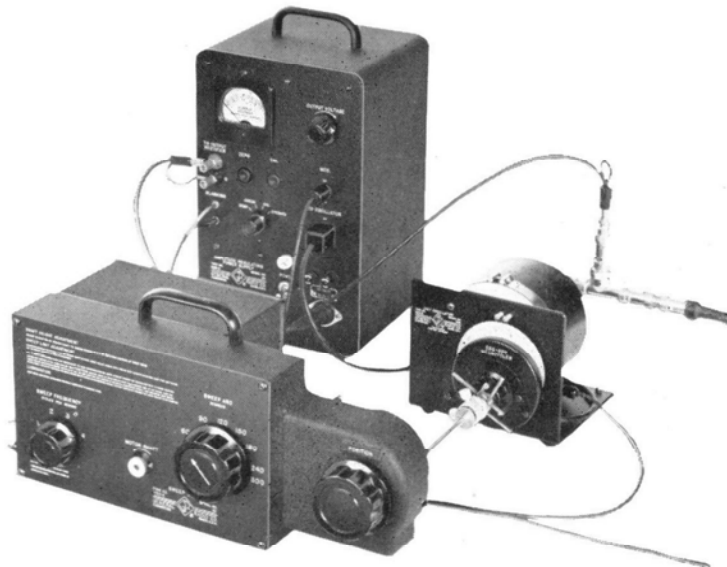

**AUTOMATIC SWEEP DRIVE FOR THE SLOTTED LINE**

For the automatic sweeping of the slotted-line, which is used in VHF and UHF measurements, see page 48.



### AUTOMATIC DIAL DRIVES

Today, sweeping techniques that utilize oscilloscopes for visual indications and recorders for permanent records are becoming more and more popular. An inexpensive solution to adapting manually-operated equipment to sweep operation, is the TYPE 908-P Synchronous Dial Drives or the TYPES 907-R and 908-R X-Y Dial Drives. For equipment that uses TYPE 907 or 908 Dials, these dial drives replace the knob with a motor drive directly. The TYPE 908-P Drives attach to either front-of-panel or back-of-panel TYPE

907 or 908 Dials (page 236). The TYPE 907-R and 908-R Drives attach to front-of-panel TYPE 907 or 908 Dials respectively. For equipment that does not use TYPE 907 or 908 Dials, replacing the original dial with a TYPE 907 or 908 (see page 236), will make the shaft sweepable with these Drives. Instruments that use TYPE 907 or 908 Dials are: all Unit Oscillators, TYPE 1304-B Audio Beat-Frequency Generator, TYPE 1303-A Two-Signal Audio Generator and the TYPE 1330-A Bridge Oscillator.

### TYPE 908-P SYNCHRONOUS DIAL DRIVES



**USES:** Two synchronous dial drives, differing only in speed and torque output, are available. The TYPE 908-P1 is intended for use with a graphic recorder, since its synchronous

motor supplies a convenient time base. The TYPE 908-P2 with a higher speed, although also useful with a recorder, is particularly suitable (on low-torque instruments) for limited sweep applications using an oscilloscope with a long-persistence screen for visual display.

**DESCRIPTION:** The dial drives have a synchronous motor that reverses its direction whenever it encounters a mechanical stop. To limit the sweep range to a value less than that provided by the built-in dial stops, adjustable stops that attach to the dial are provided. A pinion gear on the output shaft, a disengage lever, and a power switch and cord are provided.

### SPECIFICATIONS

**SPEED:**

Type	Pinion	908 Dial	907 Dial
908-P1	4 RPM	4/15 RPM or 225 secs/rev	4/10 RPM or 150 secs/rev
908-P2	30 RPM	2 RPM or 30 secs/rev	3 RPM or 20 secs/rev

On logarithmic frequency dials used on TYPES 1304-A and 1303-A Oscillators, the sweep times are as follows:

908-P1 50 sec/frequency decade or 15 sec/octave  
908-P2 6 2/3 sec/frequency decade or 2 sec/octave

**Torque at Pinion:** 908-P1 5 inch-ounces  
908-P2 2 1/2 inch-ounce

**Power Supply:** 105 to 125 volts, 50-60 cycles.

**Dimensions:** 3 5/8-inch diameter x 3 inches deep, over-all, excluding power cord.

**Weight:** 1 pound, 3 ounces.

**Note:** Data are for 60-cycle operation. Multiply speeds by 5/6 for 50-cycle operation.



TYPE 908-P2 Synchronous Dial Drive mounted on a TYPE 1304 Beat-Frequency Audio Generator.

Type	Code Word	Price
908-P1 Synchronous Dial Drive.....	SYNDO	\$27.50
908-P2 Synchronous Dial Drive.....	SYNKA	27.50

**DIALS FOR USE WITH THESE DRIVES**—See page 236 for TYPE 907 and 908 Gear-Drive Precision Dials.



## TYPE 907-R AND 908-R X-Y DIAL DRIVES

**USES:** It is often desirable to have a sweep voltage proportional to shaft position, as well as an automatic sweep. This sweep voltage is used to drive the independent variable axis of an x-y plotter, an oscilloscope, or a separate channel on a single-axis recording system. The X-Y Dial Drives include a potentiometer to supply this sweep voltage. In oscilloscope work, because of the relatively slow sweep speeds, the oscilloscope tubes with long-persistence screens (P-7 phosphor) should be used.

**DESCRIPTION:** The higher-speed models operate with a self-reversing synchronous motor in the same way as the TYPE 908-P Synchronous Dial Drives. The lower-speed models drive the dial in a counter-clockwise (increasing frequency on GR oscillators) direction only. A friction clutch is supplied to prevent damage if the motor is permitted to run after the dial has reached its stop. The synchronous motors used in these drives provide a convenient time base for recorder plots.

When mounted, the drive motor may be disengaged from the dial for manual operation of the instrument with a direct-coupled knob on the dial drive. This knob is also used to rotate a friction coupling to center the potentiometer about any dial setting.



TYPE 908-R X-Y Dial Drive mounted on a TYPE 1208-B Unit Oscillator.

For use with a wide range of d-c output levels, and, therefore, with a wide variety of recorders, binding posts are provided for the insertion of a selected d-c supply voltage to the drive potentiometer. Binding posts are also available for the position signal output. A power switch and cord are included.

### SPECIFICATIONS

**Power Supply:** Motor: 105-120 volts, 50-60 cycles, 3 watts. Potentiometer, see below.

**Dimensions:** 907-R 4 (diameter) x 3<sup>7</sup>/<sub>8</sub> (deep) inches.  
908-R 5<sup>3</sup>/<sub>4</sub> (diameter) x 3<sup>7</sup>/<sub>8</sub> (deep) inches.

**Weight:** 907-R one pound, 11 ounces.  
908-R two pounds.

**Note:** Data are for 60-cycle operation. Multiply speeds by <sup>5</sup>/<sub>6</sub> for 50-cycle operation.

Type	Dial	Pinion Speed	Dial Speed	Rotation	Center-tapped Potentiometer Resistance	Max Potentiometer Current	Resolution
907-R18	907	1/2 RPM	18°/min	CCW	20 kΩ	10 ma	0.4°
907-R144	907	4 RPM	144°/min	Self-reversing	20 kΩ	10 ma	0.4°
908-R12	908	1/2 RPM	12°/min	CCW	50 kΩ	10 ma	0.2°
908-R96	908	4 RPM	96°/min	Self-reversing	50 kΩ	10 ma	0.2°

Type		Code Word	Price
907-R18	X-Y Dial Drive.....	EARLY	\$55.00
907-R144	X-Y Dial Drive.....	EDUCE	55.00
908-R12	X-Y Dial Drive.....	EGRET	55.00
908-R96	X-Y Dial Drive.....	EJECT	55.00

**DIALS FOR USE WITH THESE DRIVES**—See page 236 for TYPE 907 and 908 Gear Drive Precision Dials.

# UNIT INSTRUMENTS

General Radio Unit Instruments are electronic building blocks for the laboratory. Their compact, rugged construction makes them equally useful for production-line testing. They are simple, inexpensive, high-quality, high-performance units that can be used individually or combined to form more elaborate systems.

Uniformity of cabinet and power supply design permit economies in manufacture, without sacrifice of performance, utility, or quality.

The purpose of the Unit line is to make available to laboratories at a reasonable price, simple, basic instruments that are needed

for everyday work. These Units are particularly suitable for the educational laboratory, where they are not only easy to fit into the budget, but help the student to see an elaborate system as a combination of simpler component apparatus.

**FEATURES:** ➤ Laboratory accuracy.

- Low cost.
- Reliable.
- Versatile, with 874 Coaxial Elements.
- Add-a-unit flexibility.
- Compact construction.
- Simple to operate.
- Can be relay-rack mounted.

## OSCILLATORS

**TYPE 1214-A UNIT OSCILLATOR—400c & 1000c, \$68.00.**

**TYPE 1214-AS2 UNIT OSCILLATOR—120c, \$95.00.**

Modulator for high-frequency oscillators; power source for bridges. Built-in a-c power supply 115 v, 60 c. Low distortion.

**TYPE 1210-B UNIT R-C OSCILLATOR—20c to 0.5 mc, \$165.00.**

General purpose — sine and square wave output — outputs 50, 2,500 and 12,500-ohms — slow-motion drive — 2 watts maximum — requires Unit Power Supply.

**TYPE 1211-B UNIT OSCILLATOR—0.5 to 50 Mc, \$265.00.**

Power source for bridges — general purpose — audio a-m modulation from TYPE 1214-A or other external source — well shielded — precision drive, 2 logarithmic ranges — 200 mw — requires Unit Power Supply.

**TYPE 1215-B UNIT OSCILLATOR—50 to 250 Mc, \$190.00.**

Power source for measurements — audio modulation from TYPE 1214-A or other external source — uses GR Butterfly circuit — precision drive — requires Unit Power Supply.

**TYPE 1208-B UNIT OSCILLATOR—65 to 500 Mc, \$200.00.**

General purpose — exceptionally wide range — audio modulation from TYPE 1214-A or other external source — well shielded — 80 mw — precision drive — requires Unit Power Supply.

**TYPE 1209-B UNIT OSCILLATOR—250 to 920 Mc, \$235.00.**

Power source for measurements — frequency covers all UHF television channel frequencies — uses GR Butterfly circuit — 200 mw — audio modulation from TYPE 1214-A or other external source — precision drive — requires Unit Power Supply.

**TYPE 1218-A UNIT OSCILLATOR—900 to 2000 Mc, \$465.00.**

Power source for measurements — pulse, square-wave, and sine-wave modulation from TYPE 1217-A, TYPE 1210-B and TYPE 1214-A — grounded-grid — tuned with transmission lines in grid and cathode circuits — 200 mw — precision drive — requires Unit Power Supply.

**TYPE 1220-A UNIT KLYSTRON OSCILLATOR—2700 to 7425 Mc, \$205.00 less klystron.** Power source for measurements — eight separate reflex klystron tubes with self-contained cavities to cover range — amplitude modulation: internal 1000-cycle square wave — square wave or pulse from TYPE 1210-B or TYPE 1217-A — frequency modulation or sweep: sine-wave from TYPE 1214-A, TYPE 1210-B, or 60 c line — 75 mw.



See pages 112, 27



See page 114

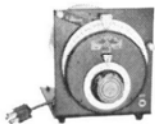

See page 113

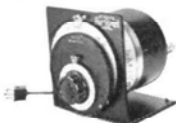

See page 116

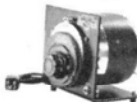

See page 116



See page 116



See page 116



See page 118



**TYPE 1213-C FREQUENCY/TIME CALIBRATOR—\$195.00.**

Secondary frequency standard — includes stable crystal, multivibrator, heterodyne detector, pulse amplifier — produces harmonics for calibration up to 1000 Mc — also pulses for 'scope calibration — requires Unit Power Supply.

See  
page  
88

**TYPE 1217-A UNIT PULSER—\$235.00.**

Compact, versatile pulse generator — pulse duration 0.2 to 60,000  $\mu$ sec. — rise time, 0.05  $\mu$ sec. — internal repetition rates, 30 c to 100 kc — square waves at any frequency in range — output 20 volts — external drive, if desired — output impedance, 200 $\Omega$  for positive pulses, 1500 $\Omega$  for negative — requires Unit Power Supply.

See  
page  
122



## AMPLIFIERS AND DETECTORS

**TYPE 1206-B UNIT AMPLIFIER—\$85.00.**

Single-ended push-pull circuit — output 3 watts, 20 c to 50 kc; 1.5 watts 10 c to 100 kc; 0.5 watt at 250 kc — output impedance, 600 $\Omega$  — less than 1% harmonic distortion — droop in 30-c square wave, 15% open circuit; rise time, 1 $\mu$  sec, open circuit — max. gain 34 db — requires Unit Power Supply.

See  
page  
5

**TYPE 1219-A UNIT PULSE AMPLIFIER—\$185.00.**

Over 500 ma load current available — output impedance, 50 to 150 $\Omega$  for positive pulses, 50 to 430 $\Omega$  for negative — driving voltage, 20 v negative, 2 v positive — max. pulse duration, negative drive, 1000  $\mu$ sec; positive, 5000  $\mu$ sec — duty ratio 0.1 and 0.5 — rise and decay time, 0.04  $\mu$ sec — built-in power supply.

See  
page  
123

**TYPE 1212-A UNIT NULL DETECTOR—\$145.00.**

Sensitive, wide-frequency range, logarithmic voltage indicator for use as null detector in a-c bridge measurements — less than 40  $\mu$ v for 1% deflection at 1 kc — range 30 c to 5 Mc — on-scale range of 120 db — requires Unit Power Supply.

See  
page  
66

**TYPE 1216-A UNIT I-F AMPLIFIER—\$335.00.**

30-Mc i-f amplifier with 0.7 Mc pass band — 2  $\mu$ v sensitivity — accurately calibrated attenuator and meter — 80 db range — for use with crystal mixer and Unit Oscillator, as indicator in heterodyne-type null detector from 50 Mc to 5000 Mc — also to measure relative signal levels, attenuation, TV transmitter harmonics, crosstalk, etc. Has own 115 v, 60 c power supply which can also supply companion Unit Oscillator.

See  
page  
68



## POWER SUPPLIES

**TYPE 1203-A UNIT POWER SUPPLY—\$40.00. See page 144.**

Recommended for use with most Unit Instruments, unless more specialized uses require one of the other supplies — 300 volt d-c, up to 50 ma — 6.3 v a-c, 3 amp — operates from 115-v, 60 c.

**TYPE 1201-A UNIT REGULATED POWER SUPPLY—\$80.00. See page 145.**

Plugs into Unit Instrument — supplies 6.3 v a-c at 3 amp; 300 volts regulated d-c up to 50 ma — operates from 115 v, 50 to 60 c.

**TYPE 1202-A UNIT VIBRATOR POWER SUPPLY—\$125.00. See page 146.**

For field use where a-c line is not available — operates from 6 v or 12 v storage battery, or equally well from 115-volt a-c line — output, 300 v d-c at 55 ma; 6.3 v a-c at 2.7 amp — with battery input, 115-volt, 115-cycle output also available.

**TYPE 1204-B UNIT VARIABLE POWER SUPPLY—\$95.00. See page 145.**

Includes Variac<sup>®</sup> Autotransformer for adjusting plate voltage — panel meter indicates a-c output voltage and current — 0 to 300 v d-c at 100 ma; 6.3 v a-c at 3 amp — output available at binding posts as well as multipoint connector.



## VARIAC® AUTOTRANSFORMERS

General Radio's famed VARIAC® auto-transformer gives smooth, continuous, manual control of a-c voltage from zero to 17% above input line voltage. Available in single units and in combinations in ratings from 300 va to 25 kva, Variacs are designed for continuous service, long life, and minimum maintenance.

**USES:** A few of the countless applications of the Variac in the shop and in the laboratory are:

- Control of a-c voltage in testing and development work.
- Control of electric heaters and ovens in the laboratory and pilot plant.
- Overvoltage and undervoltage tests.
- Output voltage control in transformer-rectifier power supplies.
- Voltage control on racks for aging of lamps, vacuum tubes, and dry-disk rectifiers.
- Lighting control in theaters, auditoriums, photographic studios, and darkrooms.
- Motor speed control.
- Voltage control in the calibration of voltmeters and ammeters.
- Phase-angle control in the calibration of wattmeters and power-factor meters.
- Variacs, although built for 115- and 230-volt circuits, can be used on circuits of higher or lower voltage in conjunction with fixed-ratio auxiliary transformers. Ganged units are available for parallel, series, and polyphase connections (see page 208).

**DESCRIPTION:** The Variac consists of a single-layer winding on a toroidal iron core. As the dial is rotated a carbon brush contact traverses the winding, "tapping off" a portion of the

total voltage across the winding. The brush is always in contact with the winding, and the voltage between turns is always less than 1 volt, even in the largest models, while in the smallest model it is only about 0.3 volt.

The voltage increments obtained as the dial is turned are always less than the voltage between turns; since the brush spans more than one turn, the change in voltage is practically continuous. The brush characteristics are such that excessive heating does not occur in the turns bridged by the brush.

**DURATRAK:** W-, V-, and M-model Variacs have brush tracks treated by the *Duratrak*\* process, which coats the brush-track surface with a uniform silver alloy, to prevent oxidation and brush-track deterioration. *Duratrak* makes the Variac as durable as a fixed-ratio autotransformer. *Duratrak* means long life, high overload capacity, and minimum maintenance requirements. With *Duratrak*, a Variac can stand a momentary overload of 1000 percent without damage.

**FEATURES:**

- High efficiency
- Smooth control
- Good voltage regulation
- Negligible waveform distortion
- Voltage varies linearly with dial rotation
- Output voltage is essentially independent of load.
- Availability of output higher than line voltage.
- Adaptability of W- and M-models to motor drive, if desired.

\*Developed in the General Radio Laboratories.  
PATENT NOTICE: See Note 8, page viii.

**TERMINAL PLATE**

Terminal plate of high-impact-strength molded phenolic has barriers between terminals to prevent accidental short circuits.

**CIRCUIT**

Circuit diagram printed on terminal plate assists in making proper connections.

**TERMINALS**

Terminals are combination screw and solder type.

**BRUSH**

General Radio unit brush, designed for constant contact pressure. Brush holder cannot touch winding if brush is damaged — prevents burn-outs. Brush is easily and quickly replaced if necessary.

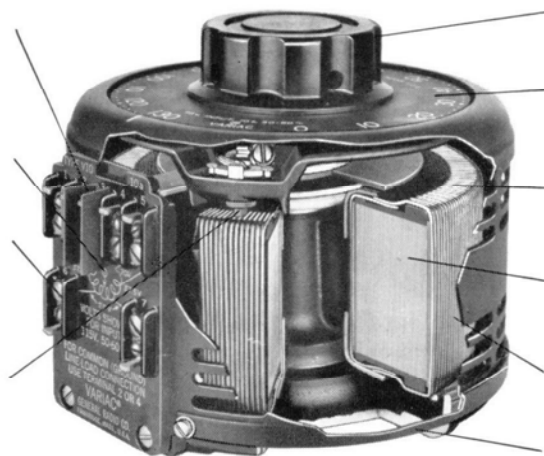

Cutaway view of V-model Variac

**KNOB**

Large, fluted, positive-grip knob.

**DIAL**

Dial indicates output voltage in large numerals, easily read from a distance.

**DURATRAK**

Duratrak coating prevents brush-track deterioration on overloads, lengthens life.

**CORE**

Strip-wound core of high-grade silicon steel.

**WINDING**

Smooth, uniform winding, banked on inside of toroid, single layer on outside.

**WEIGHT**

Aluminum structural parts minimize weight.

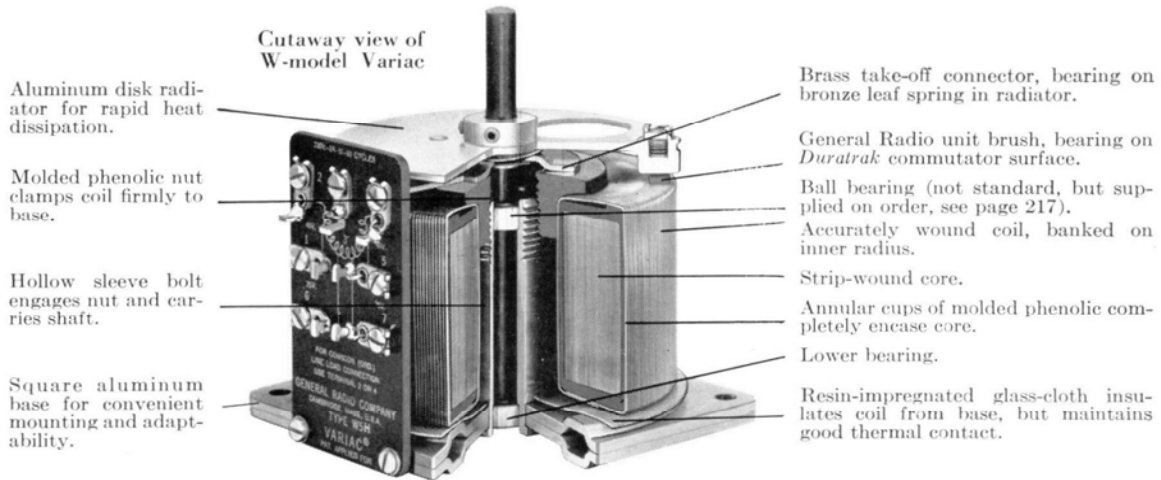

**GENERAL SPECIFICATIONS**

**Frequency:** Specifications of W- and V-models are for 50- to 60-cycle service. Variacs can be operated at rated current and voltage at line frequencies from 50 to 400 cycles. For 25-cycle service, refer to page 216. For 400- to 1200-cycle service, refer to page 215.

**Rated Current** can be drawn from the Variac at any dial position. When the overvoltage connection is used, the load should not take more than rated current at maximum output voltage.

**Maximum Current** can be drawn at the input line voltage when the line-voltage connection is used. At any lower setting the Variac will control a constant-impedance load drawing no more than the maximum current at line voltage.

**Output Voltage** is the range of voltage available at the output terminals with rated input voltage.

**Terminals:** Type W2, W5, V-10, and V-20 have combined soldering and screw-type terminals. Type 50 models have self-locking terminals, and provision for attached armored cable or conduit.

**Line-Voltage or Overvoltage Output Connections:** "Line Voltage Connection" refers to the connection for output voltage range of zero to line voltage. "Overvoltage connections" refers to the connection for output voltage range of zero to 17% above line voltage.

**KVA Rating** is the maximum current multiplied by normal input line voltage. A Variac can handle, at any lower setting, a constant-impedance load that draws at rated input voltage a current no greater than the maximum current.

**Temperature Rise:** Variac ratings are based on operation at ordinary room temperatures, with an average temperature rise of not more than 50° C. When ambient temperature exceeds 50° C, kva ratings should be decreased as shown in the chart on this page.

**No-Load Loss** is measured at 60 cycles with rated input voltage. Losses are guaranteed not to exceed the values given in specifications.

**Driving Torque** is the torque required to turn the Variac shaft.

**Panel Thickness** is the maximum thickness of the panel on which the Variac can be mounted, with the shaft normally supplied.

**Mounting:** See photographs on Pages 208 to 217.

**Dimensions:** Over-all dimensions are given with the individual Variac descriptions. Complete dimensional sketches and drilling templates will be furnished on request.

**Weight:** See individual specifications.

For ambient temperatures above 50 deg. C. the VARIAC should be derated according to this curve.

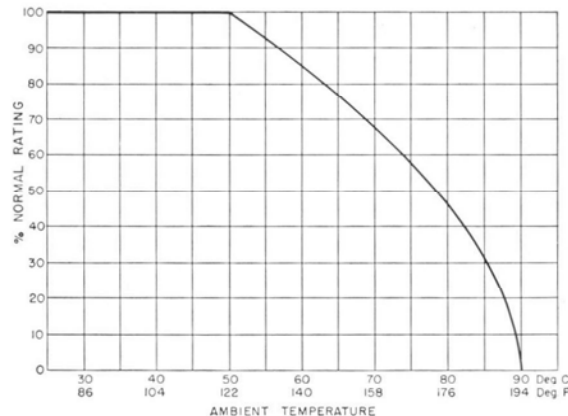

For use when high initial surge current may be expected (motor starting, incandescent lamp load, etc.) and for short-time overloads, the VARIAC rated current may be exceeded on a time-current basis as shown in this figure. This curve applies to Duratrak Variacs ONLY.

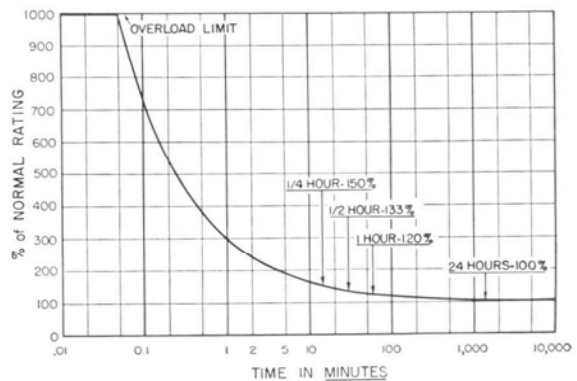



## GANGED VARIAC® ASSEMBLIES

### FOR PARALLEL, SERIES, AND THREE-PHASE OPERATION

The usefulness of the Variac is adapted, through two- and three-gang Variac assemblies, to the control of several circuits from a single knob, or to the control of

three-phase circuits. The wye and open-delta connections are the most commonly used.

#### PARALLEL COMBINATIONS

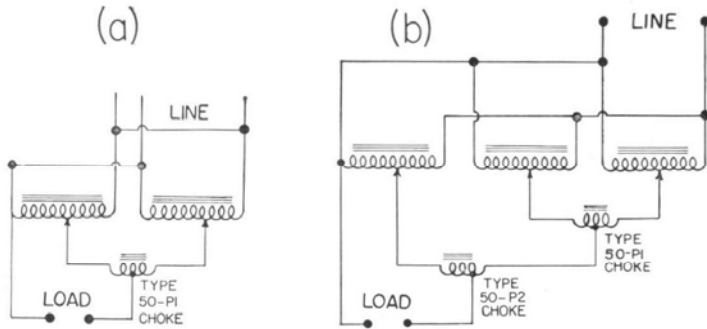

The larger-size VARIACS (V-20 and TYPE 50) can be operated in parallel if a TYPE 50-P1 Choke is used to limit circulating current, as shown in circuit (a) at left. Load rating of two identical VARIACS in parallel is twice that of a single VARIAC. Parallel operation is not usually recommended for smaller VARIACS, because the use of the next larger size VARIAC is more economical. Where a load rating in excess of two TYPE 50 units is needed, a third unit can be added by using a TYPE 50-P2 Choke, as shown in circuit (b). See page 214 for prices of chokes.

#### THREE-PHASE COMBINATIONS

**Open-Delta Connection:** With this connection, two Variacs will control a three-phase load from a three-phase source. Maximum output voltage can be either line voltage or 17 percent above line voltage. The load rating of a two-gang open-delta circuit is 1.732 times that of a single Variac. With 230-volt models, output voltages of more than double the supply voltage can be obtained, although current and power ratings are halved.

**Wye Connection:** Wye-connected Variacs can be operated from three-phase lines of twice the Variac voltage rating. This is because the voltage across each leg of a wye-connected assembly equals line volts divided by  $\sqrt{3}$ , and because 115-volt Variacs are wound for a maximum of 135 volts and 230-volt Variacs are wound for a maximum of 270 volts. With the wye connection, the voltage across the Variac on a 460-volt line is 266 volts, and on a 230-volt line, 133 volts. Although the over-voltage feature is sacrificed in this circuit, the kva rating is increased by the ratio 133:115. Load rating of a wye-connected assembly is 3.47 times that of a single unit.

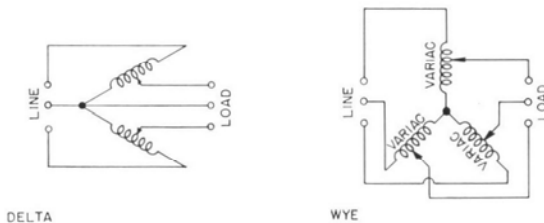

DELTA

WYE

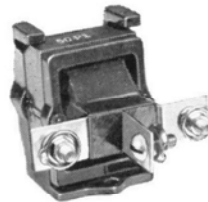

TYPE 50-P1 Choke for limiting circulating current in parallel combinations.

#### SERIES OPERATION

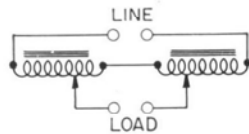

The series connection is useful in the operation of 115-volt units from 230-volt lines and 230-volt units from 460-volt lines. This circuit cannot be used, however, when a common connection between line and load is required, as, for instance, when the load is grounded.

Ganged Variacs are supplied completely assembled and ready for wiring and installation.

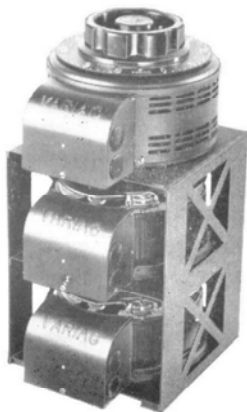

Left: A three-gang TYPE V-20 Variac, (TYPE V-20G3).

Right: A three-gang TYPE W5 Variac (TYPE W5G3). For photo of a cased W-model gang, see page 210. For a TYPE 50 gang, see page 214.

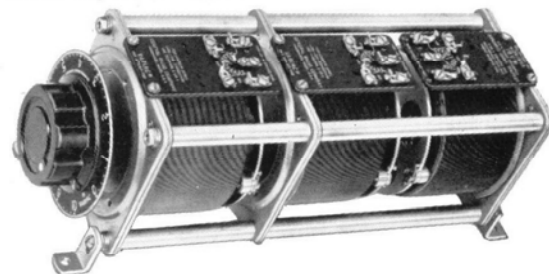



## THE W-MODEL VARIAC

The new W-model Variac is the latest result of a continuous development program that started over 20 years ago, when General Radio introduced the first commercial variable auto-transformer. The advent of the W-model is a major stride in this development. Design features include Underwriters Laboratory listing, military ruggedization, and counterbalanced rotating parts. The basic open units have increased ratings and square mounting bases for convenient installation. Cased models are totally enclosed for protection from dust, with ready access to the interior. Wall-mounted, cased models have conduit knockouts, for ganged assemblies as well as for individual units.

A new portable model, which can be used in either a horizontal or a vertical position, has a built-in circuit breaker and is supplied with a carrying handle. This model is available with the new standardized three-wire grounded cord set and receptacle, as well as with the more usual two-wire arrangement.

W-model Variacs, which are available in the popular 2- and 5-ampere sizes, are interchangeable with comparable-size V-models\*, since mounting holes corresponding to those of V-models are provided on the W-model base.

The flexibility of the new design permits the manufacture of units incorporating many special modifications, such as the addition of ball bearings, motor drive, continuous 360-degree rotation, and two separate brush tracks. All W-models are *Duratrak* treated.

M-model Variacs for 400- to 1200- cycle service are similar in design to W-models (page 215).

\* V-models in these sizes are still available for those who find it inconvenient to change to the new W-models.



Portable model with convenient handle has overload protector and is available in 2- and 3-wire models.



Cased model for wall mounting has conduit knockouts.

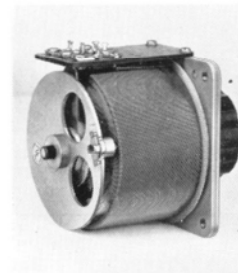

Uncased model has higher rating, lower price than its predecessor.

### VARIAC INDEX

115-VOLT INPUT		
KVA	Type	Page
0.36	W-2	210
0.9	W-5	211
1.5	V-10	212
3	V-20	213
5	50-A	214
6	V-20G2	213
9	V-20G3	213
10	50-AG2	214
15	50-AG3	214

SINGLE PHASE	230-VOLT INPUT		
	KVA	Type	Page
	0.6	W-5H	211
		W-2G2	210
	1.2	V-10H	212
	1.8	W-5G2	211
	2.4	V-20H	213
	3	V-10G2	212
	4.8	V-20HG2	213
	6	V-20G2	213
7	50-B	214	
14	50-BG2	214	
21	50-BG3	214	

460-VOLT INPUT		
KVA	Type	Page
1.2	W-5HG2	211
2.4	V-10HG2	212
4.8	V-20HG2	213
14	50-BG2	214

THREE PHASE	230-VOLT INPUT		
	KVA	Type	Page
	1.0	W5HG2	211
		W2G3	210
	2.0	V-10HG2	212
	3.1	W5G3	211
	4.0	V-20HG2	213
	5.0	V-10G3	212
	10	V-20G3	213
	12	50-BG2	214
18	50-AG3	214	

460-VOLT INPUT		
KVA	Type	Page
2.1	W5HG3	211
4.0	V-10HG3	212
8.0	V-20HG3	213
25	50-BG3	214

Motor Drives	217
Specials	217
High-Frequency Units	215-6
25-cycle Ratings	216



Cover of cased model is easily removable for access to terminals, mounting holes, and brush.

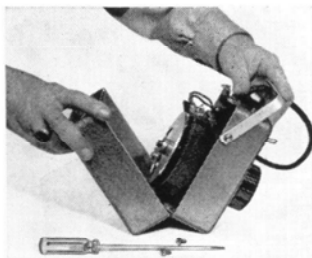

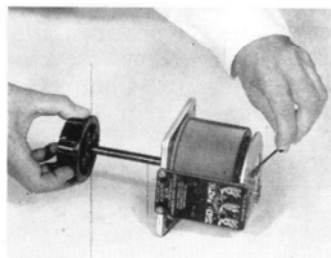
Shaft can be easily adjusted or replaced without disturbance to the rest of the assembly.



Overload protector, a new feature on portable models, is reset from front panel.



**NEW TYPE W2 VARIAC WITH DURATRAK**

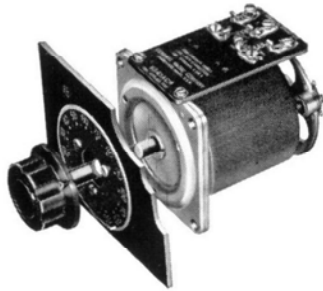

**Type W2**  
Uncased Model.  
Mounting Base: 3¼ inches square.  
Depth Behind Panel: 3<sup>15</sup>/<sub>16</sub> inches.  
Four Mounting Holes on 2¾-inch square.  
Max. Panel: ⅜ inch.

**Type W2M**  
Cased Model, with Conduit Knockouts.  
Case Dimensions: Width 4<sup>1</sup>/<sub>8</sub> in., Height: 5<sup>9</sup>/<sub>16</sub> in., Depth: 4¼ in.



**Type W2MT**  
Portable Model.  
For 2-Wire Service (Type W2MT3 for 3-Wire).  
With Overload Protector, Carrying Handle, Cord, Plug, and Outlet.  
Case Dimensions: same as for W2M.

Ideal for laboratory use, speed controls on small motors, voltage control on electronic equipment, and for use with x-ray, diagnostic, and therapeutic instruments, these small Variacs have all the features of the new W line. The W2 can be supplied with ball bearings

and motor drives, and is available either as a cased, uncased, or portable unit, for a wide variety of mounting arrangements. Mounting holes to match those of the older Type V-2 are also included.

Type	Mounting	Input Voltage	Line-Voltage Connection			Overvoltage Connection		60-cps no-load loss — watts	Driving torque ounce-inches	Net Weight — pounds	Code Word	Price
			Rated Output Current — amp.	Output Voltage	Maximum Current — amp.	Output kva	Output Voltage					
W2	Uncased	115	2.4	0-115	3.1	0.36	0-135	2.4	3.5	5-10	3 <sup>5</sup> / <sub>8</sub>	BAGAL \$13.50
W2M	With case	115	2	0-115	2.6	0.30	0-135	2	3.5	5-10	4 <sup>1</sup> / <sub>8</sub>	BAGER 18.00
W2MT	Portable 2-wire	115	See Note Below				0-135	2	3.5	5-10	4 <sup>3</sup> / <sub>4</sub>	BAGIC 24.00
W2MT3	Portable 3-wire	115	See Note Below				0-135	2	3.5	5-10	4 <sup>3</sup> / <sub>4</sub>	BAGOM 26.00

MT models are shipped with overvoltage connections and corresponding dial scales, but can be supplied on special order with line-voltage connections and dial scales.

The TYPE W2 dial plate is reversible, with 0-115 on one side, and 0-135 on the other. Angle of rotation is 320 degrees. Replacement brushes for TYPE W2 Variacs are TYPE VB-1, 55¢ each.

Complete dimension drawings furnished on request.

**GANGED ASSEMBLIES.** One unit in each gang is reversed to provide a mounting base at each end of the assembly. A set of right-angle mounting brackets is also supplied. Assemblies are available either cased or uncased.

Type	Description	Weight	Code Word	Price
W2G2	2-gang W2	7	BAGALGANDU	\$32.00
W2G3	3-gang W2	11	BAGALGANTY	48.00

For cased assembly, add suffix M to TYPE Number, and add \$8.00 to price. Dials are marked 0 to 10 on one side, 10 to 0 on the other. To determine ratings of gang for various classes of service, refer to page 208. For ball

bearings and motor drive, refer to page 217. For 25-cycle operation, refer to page 216.

Complete dimension drawings furnished on request.

TYPE W2G2M, 2-gang W2, with case. See page 208 for view of uncased ganged assembly.

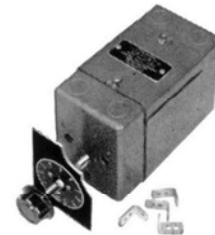



NEW TYPE W5 VARIAC WITH DURATRAK



**Types W5, W5H**  
 Uncased Model.  
 Mounting Base: 4½ inches square.  
 Depth Behind Panel: 4 inches.  
 Four Mounting Holes on ¾ inch square.  
 Max. Panel: ⅜ inch.

**Types W5M, W5HM**  
 Cased Model, with Conduit Knockouts.  
 Case Dimensions:  
 Width 4⅞ in., Height 6⅞ in., Depth 4¼ in.



**Types W5MT, W5HMT**  
 Portable Model.  
 For 2-Wire Service (TYPE W5MT3 for 3-wire).  
 With Overload Protector, Carrying Handle, Cord, Plug and Outlet.  
 Case dimensions same as for TYPE W5M.

Additional mounting holes matching those of the older TYPE V5 to facilitate interchangeability. (For the few instances where replace-

ment of the V by the W Variac is impossible, manufacture of the V5 is being continued.)

Type	Mounting	Input Voltage	Line-Voltage Connection				Overvoltage Connection		60-cycle no-load loss — watts	Driving torque ounce-inches	Net Weight — pounds	Code Word	Price
			Rated Output Current — amp.	Output Voltage	Maximum Current — amp.	Output kva	Output Voltage	Rated Output Current — amp.					
W5	Uncased	115	6	0-115	7.8	0.9	0-135	6	9	10-20	6¾	COTAL	\$17.00
W5M	With case	115	5	0-115	6.5	0.75	0-135	5	9	10-20	7½	COTER	21.50
W5MT	Portable 2-wire	115	See Note Below				0-135	5	9	10-20	8¼	COTIC	26.50
W5MT3	Portable 3-wire	115	See Note Below				0-135	5	9	10-20	8¼	COTOM	28.50
W5H	Uncased	230	2	0-230	2.6	.6	0-270	2	9	10-20	6½	JOBAL	19.00
		115	1				0-270	1					
W5HM	Cased	230	2	0-230	2.6	.6	0-270	2	9	10-20	7¼	JOBER	23.50
		115	1				0-270	1					
W5HMT	Portable 2-wire	230	See Note Below				0-270	2	9	10-20	8	JOBIC	28.50

MT models are shipped with overvoltage connections and corresponding dial scales, but can be supplied on special order with line-voltage connections and dial scales. Complete dimension drawings furnished on request.

The TYPE W5, W5M, W5H, and W5HM dial plates are reversible, with line-voltage scale on one side, and over-voltage scale on the other. Angle of rotation is 325 degrees for W5, 323 degrees for W5H.

Replacement brushes for TYPE W5 Variacs are TYPE VB-2, 55¢ each; for TYPE W5H Variacs, TYPE VB-1, 55¢ each.

**GANGED ASSEMBLIES.** One unit in each gang is reversed to provide a mounting base at each end of the assembly. A set of right-angle mounting brackets is also supplied. Assemblies are available either cased or uncased.

For cased assembly, add suffix M to type number and add \$8.00 to price. Dials are marked 0 to 10 on one side, 10 to 0 on the other. To determine ratings of gangs for va-

rious classes of service, refer to page 208. For ball bearings and motor drive, refer to page 217. For 25-cycle operation, refer to page 216.

Type	Description	Weight	Code Word	Price
W5G2	2-gang, 115 v	14½	COTALGANDU	\$41.00
W5HG2	2-gang, 230 v	14	JOBALGANDU	45.00
W5G3	3-gang, 115 v	21¼	COTALGANTY	61.00
W5HG3	3-gang, 230 v	20¾	JOBALGANTY	67.00

The cased models, TYPES W5M, W5MT, and W5MT3, are listed under the reexamination service of the Underwriters Laboratories and may be installed in any normal locations. The uncased TYPE W5 is listed for use in applications where the installation is approved.



TYPE V-10MT,  
V-10HMT.



**THE V-10 VARIAC  
WITH DURATRAK**

Available in several models, all of which have *Duratrak* construction, the V-10 Variac, with 10 amperes rated current and 13 amperes maximum, for 115-volt service, approaches the capacity of commonly used outlets, cords, plugs, and No. 14 wire circuits.

TYPES V-10 and V-10M are listed under the re-examination service of the Underwriters Laboratories.

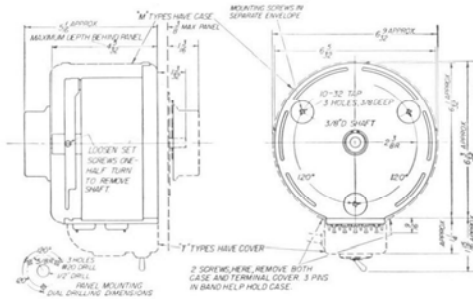

TYPE V-10M, V-10HM



TYPE V-10, V-10H

Type	Mounting	Input Voltage	Line-Voltage Connection			Overvoltage Connection		60-cycle no-load loss — watts	Driving torque ounce-inches	Net Weight — pounds	Code Word	Price
			Rated Output Current — amp.	Output Voltage	Maximum Current — amp.	Output kva	Output Voltage					
V-10	Uncased, with terminal strip	115	10	0-115	13	1.5	0-135	10	17	30-60	11 1/4	HAZEL \$33.00
V-10M	With case and terminal strip	115	10	0-115	13	1.5	0-135	10	17	30-60	11 5/8	HEAVY 35.50
V-10MT	With case, terminal box, cord, plug, switch	115	10	See Note below			0-135	10	17	30-60	12 1/8	HELOT 40.00
V-10H	Uncased, with terminal strip	230 115	4 2	0-230	5.2	1.2	0-270 0-270	4 2	17	30-60	10 5/8	HINNY 34.00
V-10HM	With case and terminal strip	230 115	4 2	0-230	5.2	1.2	0-270 0-270	4 2	17	30-60	11	HOARY 36.50
V-10HMT	With case, terminal box, cord, plug, switch	230	4	See Note below			0-270	4	17	30-60	11 1/2	HOBBY 41.00

MT models are shipped with overvoltage connections and corresponding dials, but can be supplied on special order with line-voltage connections and dials.

All models are shipped with overvoltage dials unless line-voltage dials are specified on order. Dials are reversible, one side for panel mounting, the other for table mounting. Angle of rotation is 315 degrees.

Replacement brushes for TYPE V-10 Variacs are TYPE VBT-2, 65¢ each; for TYPE V-10H Variacs, TYPE VBT-4, 65¢ each.

Complete dimension drawings furnished on request.

**GANGED ASSEMBLIES**

Dials are marked 0 to 10 on one side, 10 to 0 on the other. To determine ratings of gangs for various classes of service, refer to page 208.

Complete dimension drawings furnished on request.

Type	Weight in lbs.	Code Word	Price
V-10G2	27	HAZELGANDU	\$79.00
V-10HG2	27	HINNYGANDU	81.00
V-10G3	37 1/2	HAZELGANTY	113.00
V-10HG3	36 3/4	HINNYGANTY	116.00





## TYPE V-20 VARIAC WITH DURATRAK

Largest of the V-models, the TYPE V-20, has a capacity of 3 KVA.

TYPE V-20M,  
V-20HM

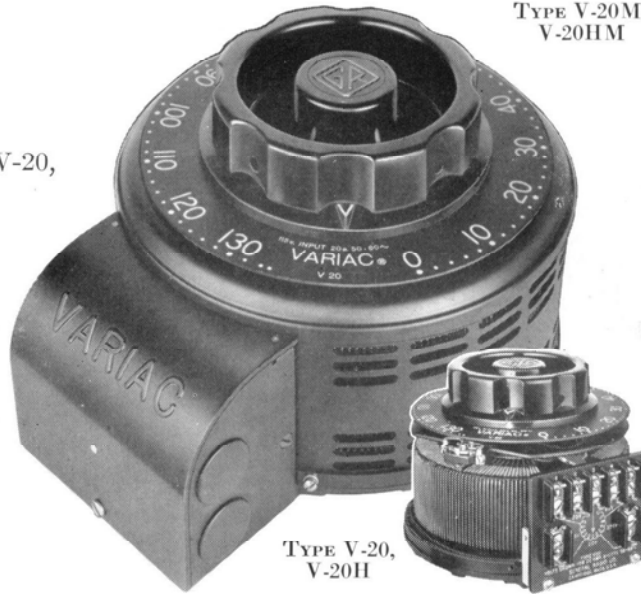
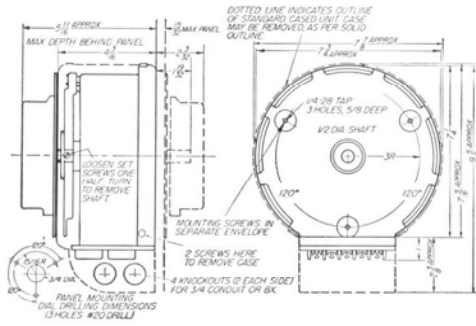

TYPE V-20,  
V-20H

Type	Mounting	Input Voltage	Line-Voltage Connection			Overvoltage Connection		60-cycle no-load Loss — watts	Driving torque—ounce-inches	Net Weight — pounds	Code Word	Price	
			Rated Output Current—amp.	Output Voltage	Maximum Current—amp.	Output kva	Output Voltage						Rated Output Current—amp.
V-20	Uncased, with terminal strip	115	20	0-115	26	3.0	0-135	20	27	55-110	22	JUNTO	\$52.00
V-20M	With case and terminal box	115	20	0-115	26	3.0	0-135	20	27	55-110	22 3/4	JEWEL	58.00
V-20H	Uncased, with terminal strip	230	8	0-230	10.4	2.4	0-270	8	27	55-110	21	JOLLY	52.00
V-20HM	With case and terminal box	230	8	0-230	10.4	2.4	0-270	4	27	55-110	21 1/2	JIMMY	58.00
		115	4				0-270	4					

All models are shipped with overvoltage dials unless line-voltage dials are specified on order. Dials are reversible, one side for panel mounting, the other for table mounting. Angle of rotation is 317 degrees for V-20, 319 degrees for V-20H. Complete dimension drawings furnished on request.

Replacement brushes for TYPE V-20 Variacs are TYPE VBT-5, \$1.30 per set; for TYPE V-20H Variacs, TYPE VBT-2-2, \$1.30 per set.

### GANGED ASSEMBLIES

Type	Weight — lbs.	Code Word	Price
V-20G2	48 1/2	JEWELGANDU	\$126.00
V-20HG2	46 1/2	JIMMYGANDU	126.00
V-20G3	69 1/2	JEWELGANTY	182.00
V-20HG3	68	JIMMYGANTY	182.00

Dials are marked 0 to 10 on one side, 10 to 0 on the other. To determine ratings of gangs for various classes of service, refer to page 208.

Complete dimension drawings furnished on request.

A TYPE 50-P1 Choke is recommended when two Variacs are operated in parallel, to limit circulating currents in case of misalignment. When three Variacs are operated in parallel, both a TYPE 50-P1 and a TYPE 50-P2 are recommended. See page 214 for prices.

### TYPE V-10 VARIACS WITH SPECIAL-PURPOSE TERMINAL BOXES

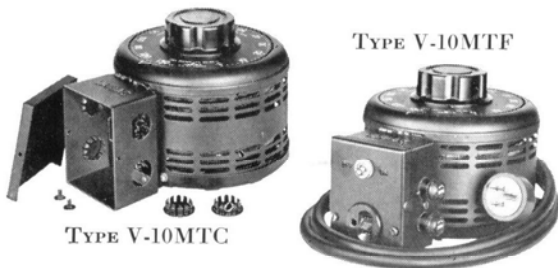

The TYPE V-10MTC Variac has standard 3/4-inch holes for BX or conduit. The TYPE V-10MTF has a three-prong output receptacle, line cord with three-prong plug, a two-pole switch, and fuses for line and output. Box dimensions of both models are 2 7/8 by 3 5/8 by 2 inches deep.

Type	Description	Code Word	Price
V-10MTC	With knockouts for conduit	HERON	\$39.00
V-10MTF	With switch and fuses for 3-wire service	CANDY	51.00



### TYPE 50 VARIAC



The largest of the Variacs, the TYPE 50 has a load rating of 5 kva for 115-volt service and 7 kva for 230-volt service. Supplied either as a single unit or in ganged assemblies, the TYPE 50 handles heavy lighting, heating, and power circuits, with ample capacity for temporary overloads.

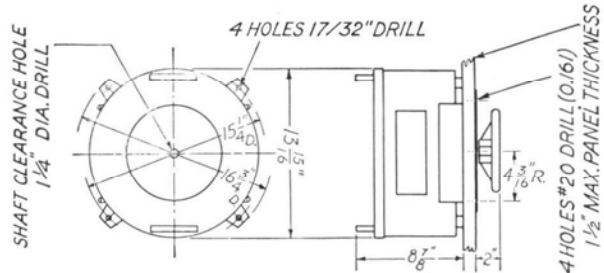

TYPE 50-A, 50-B

Type	Mounting	Input Voltage	Line-Voltage Connection			Overvoltage Connection			60-cycle no-load Loss — watts	Driving torque—ounce-inches	Net Weight — pounds	Code Word	Price
			Rated Output Current — amp.	Output Voltage	Maximum Current — amp.	Output kva	Rated Output Voltage	Rated Output Current — amp.					
50-A	With case	115	40	0-115	45	5	0-135	40	60	250-500	85	TOKEN	\$150.00
50-AU	Uncased	115	40	0-115	45	5	0-135	40	60	250-500	85	TORSO	140.00
50-B	With case	230	20	0-230	31	7	0-270	20	75	250-500	81	TOPAZ	150.00
		115	10			0-230	10						
50-BU	Uncased	230	20	0-230	31	7	0-270	20	75	250-500	81	TUDOR	140.00
		115	10			0-230	10						

Dial plates are reversible, and are marked for overvoltage connection on one side, and for line-voltage connection on the other. Angle of rotation is 339 degrees. Replacement brushes for TYPE 50 Variacs are \$5.00 per set. Specify model number when ordering. Complete dimension drawings furnished on request.

#### GANGED ASSEMBLIES

A TYPE 50-P1 Choke is recommended when two Variacs are operated in parallel, to limit circulating current in case of misalignment. When three Variacs are operated in parallel, both a TYPE 50-P1 and a TYPE 50-P2 are recommended.

Type	Net Weight	Code Word	Price
50-AG2	180 lbs.	TOKENGANDU	\$310.00
50-AG3	245	TOKENGANTY	460.00
50-BG2	175	TOPAZGANDU	310.00
50-BG3	256	TOPAZGANTY	460.00
50-P1	1 1/4	PARALLCHOK	14.00
50-P2	1 1/4	TRIPLECHOK	14.00

Dial plates are marked on only one side from 0 to 10. To determine ratings of gangs for various classes of service, refer to page 208.

Complete dimension drawings furnished on request.

A three-gang assembly of 230-volt units, TYPE 50-BG3, with a capacity of 25 KVA at 460 volts, three phase.





## TYPE M VARIACS FOR 350- TO 1200-CYCLE SERVICE



**Type M2**

Dimensions identical with TYPE W2, except depth behind panel is  $2\frac{1}{2}$  inches.



**Type M5**

Dimensions identical with TYPE W5, except depth behind panel is  $2\frac{5}{8}$  inches.



**Type M10**

Base:  $5\frac{3}{4}$  inches square; depth behind panel:  $3\frac{1}{16}$  inches; four mounting holes on  $4\frac{3}{4}$ -inch square.

TYPE M Variacs are the high-frequency equivalents of the TYPES W2, W5 and V-10. They are similar in design to the 60-cycle W-models, but are much smaller and lighter. TYPE M Variacs are especially useful with the 400-cycle power supplies that are used in airborne and maritime equipment. They can be supplied with ball bearings and 60-cycle motor drives (page 217).

**FEATURES:** ➤ TYPE M Variacs are mechanically rugged, built to withstand a vibration test of 10 to 55 cycles, 1/32-inch amplitude, and a 1200-ft-lb shock test of MIL-T-945A.

➤ The coil bears solidly, through a thin insulator, against a cast aluminum base, which in turn has an annular mounting surface. Good thermal conductivity is thus achieved between coil and base and between base and panel.

➤ Wiring diagram on terminal board.

➤ Usable from 350 to 1200 cycles per second.

➤ *Duratrak* contact surface provides extra factor of reliability under overload. Instantaneous peaks of ten times rated current can be handled.

➤ Brush track shows no significant wear after one million cycles of brush operation (0 to maximum and return).

➤ Two-ampere model (TYPE M2) has 400 turns, giving adequate resolution for many computing and control operations.

➤ Ganged assemblies are designed for minimum volume. Coils are mounted back-to-back on a single base for two-gang assembly.

➤ Variac meets military corrosion, salt-spray, and fungus-resistance requirements.

➤ Four corner mounting holes provided for ganging and mounting, in addition to the three standard mounting holes used on V-model Variacs.

➤ Can be used at 50 and 60 cycles, at reduced voltage.

Type	M2	M5	M10
Line Frequency	350-1200 cps	350-1200 cps	250-1200 cps
Input Voltage	115 v	115 v	115 v
Output Voltage	0-135 or 0-115 v	0-135 or 0-115 v	0-135 or 0-115 v
Rated Current	2 amp.	5 amp.	10 amp.
Maximum Current *	3 amp.	7.5 amp.	13 amp.
No-Load Loss at 400 c	3 w	6 w	14 w
No. of Turns on Winding	402	293	209
D-C Resistance of Winding	6.6Ω (approx)	1.3Ω (approx)	0.36Ω (approx)
Driving Torque	5-10 oz-in.	10-20 oz-in.	30-60 oz-in.
Angle of Rotation	320 degrees	325 degrees	315 degrees
Replacement Brushes	VB-1: 55¢	VB-2: 55¢	VBT-2: 65¢
Weight, Lb.	1 $\frac{7}{8}$	3 $\frac{1}{4}$	6 $\frac{5}{8}$
Code Word	BAGGY	CANNY	CABIN
Price	<b>\$14.50</b>	<b>\$18.50</b>	<b>\$30.00</b>

\* For line voltage connection only.  
For ganged models, refer to the following page.



### GANGED TYPE M VARIACS FOR HIGH-FREQUENCY SERVICE

TYPE M Variacs are available as two-gang assemblies for 115-volt, three-phase, open-delta connection (or for controlling two circuits from a single shaft), and as three-gang assemblies for 208- or 230-volt, three-phase, wye-connection (or for controlling three circuits from a single shaft).

A TYPE 50-P1 Choke is recommended if a two-gang unit is to be operated in parallel; for three-gang units, a TYPE 50-P2 Choke is required in addition to the TYPE 50-P1.

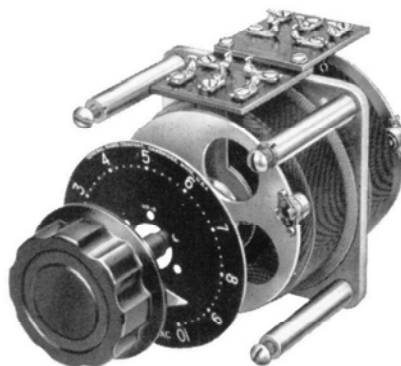

For ball bearings and motor drive, refer to page 217. Complete dimension drawings furnished on request. For prices of chokes see page 214.

Type	Description	Net Wt. Lbs.	Code Word	Price
M-2G2	2-Gang M-2	3 <sup>5</sup> / <sub>8</sub>	BAGGYGANDU	\$33.00
M-2G3	3-Gang M-2	5 <sup>1</sup> / <sub>2</sub>	BAGGYGANTY	49.50
M-5G2	2-Gang M-5	6 <sup>3</sup> / <sub>4</sub>	CANNYGANDU	41.00
M-5G3	3-Gang M-5	10 <sup>1</sup> / <sub>4</sub>	CANNYGANTY	61.50
M-10G2	2-Gang M-10	12 <sup>1</sup> / <sub>8</sub>	CABINGANDU	65.00
M-10G3	3-Gang M-10	19	CABINGANTY	97.00

### TYPE 71-A VARIAC TRANSFORMER

The TYPE 71-A Variac Transformer is a source of continuously adjustable, low-voltage power, with a completely isolated secondary winding. A step-down transformer is combined with an adjustable transformer on a common core, and the slider track is calibrated in open-circuit voltage. The simple, rugged case is easily mounted for either laboratory or built-in use. The TYPE 71-A Variac Transformer is useful in the control of cathode voltage, low-voltage testing, brightness of microscope lamps, and in similar applications.

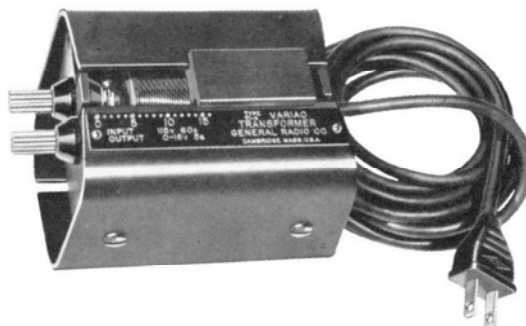

**Input:** 115 volts, 60 cycles.  
**Output Current:** 5 amp maximum.  
**Output Voltage:** 0-16 volts open circuit, 0-13 volts at 5 amp.  
**No-Load Loss:** Less than 5 watts.

**Dimensions:** Length 5<sup>1</sup>/<sub>2</sub> in., width 3<sup>5</sup>/<sub>8</sub> in., height 3<sup>1</sup>/<sub>4</sub> in., over-all.  
**Weight:** 4 lbs.

Type	Code Word	Price
71-A   Variac Transformer....	POPPY	\$27.50

### VARIACS FOR 25-CYCLE SERVICE

230-volt Variacs, designed for 60-cycle service, can be used on 25-cycle supply at

one-half their 60-cycle voltage and load ratings.

Type	Rated Input — Volts	Line-voltage Connection				Overvoltage Connection	
		Rated Output Current — Amperes	Output Voltage Range	Max Output Current — Amperes	KVA at Max Output Voltage	Output Voltage Range	Rated Output Current — Amperes
W5H W5HM W5HMT	115	2	0-115	2.6	.3	0-135	2
V-10H V-10HM V-10HMT	115	4	0-115	5.2	.6	0-135	4
V-20HM	115	8	0-115	10.4	1.2	0-135	8
50-B	115	20	0-115	31	3.5	0-135	20

For prices, code words, and other specifications see pages 211, 212, 213, and 214. When ordering, please specify that VARIAC is for 25-cycle service, in order that proper dial may be furnished.



## SPECIAL VARIACS

Special Variacs can be supplied to meet specific requirements, such as additional winding taps, fungicide treatment, special shaft lengths, or output voltages or voltage ranges different from those of standard models.

The General Radio Company welcomes in-

quiries on special Variacs, and is glad to furnish them when the quantities involved are sufficient to make production economically practicable.

Variacs can also be supplied on special order less knob, dial, etc., at lower net prices.

### BALL BEARINGS

W- and M-models can readily be supplied with ball bearings, which provide more precise alignment, and slightly lower and more constant torque.

When ordering a Variac or gang equipped with ball bearings, add the suffix -BB to the type number and add the price shown in the accompanying table.

For cutaway view of ball-bearing model, see page 207.

#### Surcharge for Ball Bearings

	W2, M-2	W5, W5H, M-5	M-10
Single.....	\$5.00	\$6.00	\$7.00
Two-gang.....	7.00	8.00	9.00
Three-gang.....	9.00	10.00	11.00

### MOTOR-DRIVEN MODELS

Motor drives can be furnished on all W-models. The motor mounting plate is attached to the Variac base by four posts, and the motor is geared to the Variac shaft. All motor-driven models are equipped with ball bearings.

Fully enclosed, two-phase, gear-reduction motors of the servo type, having very low moment of inertia, are used. Two basic speeds are available, which together with a selection of stocked standard coupling gears make possible the assembly of units having full traverse rates of 2, 4, 8, and 16 seconds. The 2- and 4-second models are intended for high-speed servo applications (such as TYPE 1570-A Line Voltage Regulator) while the 8- and 16-second models are primarily intended for remote positioning applications. The latter are normally

supplied with a phase-splitting capacitor, the former without. Limit switches are not necessary to limit rotation at the end of travel, but are available if desired for signalling purposes or to stop rotation at any point.

Cases similar to those on W gangs are available for motor-driven models, whether single units or gangs.

The price for any motor drive is approximately \$75.00 more than the price of the ball-bearing TYPE W2, W5, or W5H Variac. (The exact price varies according to quantity ordered.) Inquiries are invited. We shall be glad to recommend the most suitable model and to quote prices. Deliveries are prompt. (The 60-cycle motor drives can also be supplied with the ball-bearing TYPES M2 and M5 Variacs.)

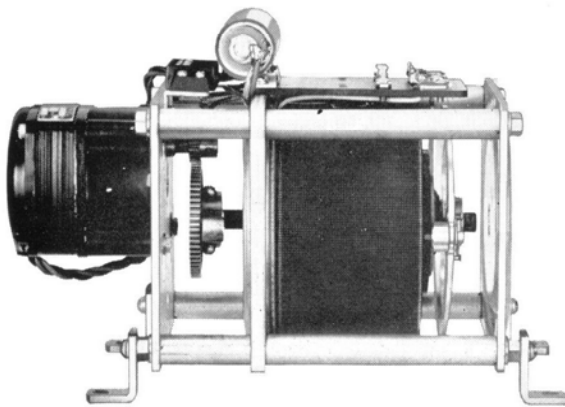

A motor-driven TYPE W5 Variac.

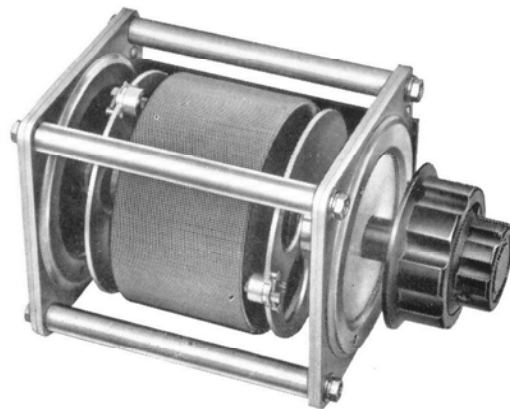

A special TYPE W5 Variac with two brushes, one at each face of winding.



## TYPE 1570-A AUTOMATIC VOLTAGE REGULATOR

HANDLES ANY LOAD UP TO 6 KVA

**USES:** The TYPE 1570-A Automatic Voltage Regulator is used in both laboratory and industrial applications where constant a-c line voltage is required. It combines high accuracy for laboratory use with large capacity for industrial applications. Typical applications for this instrument are: Laboratory power, computers, critical transmitter supply voltages, meter test benches, carefully controlled industrial processes and installation in military equipment.

**DESCRIPTION:** The TYPE 1570-A Automatic Voltage Regulator consists of a Variac® adjustable auto-transformer, an auxiliary step-down transformer which multiplies the power rating of the Variac, and a servomechanism, which controls automatically the setting of the Variac to hold the output voltage constant.

The rectified output voltage is filtered, and the d-c component compared to a stable voltage reference tube to obtain a d-c error voltage. This error voltage is amplified by a two-stage balanced amplifier with lead and

lag networks for shaping the phase and amplitude response for optimum performance.

The thyatron-controlled servo-motor is a true proportional control device rather than an off-on device and provides a smooth control with no "dead zone." The Variac driven by this servo-motor is equipped with ball-bearings to reduce friction to a minimum.

In addition to the standard models listed below, a militarized model is also available. Control circuit is on one panel; Variac, buck-boost transformer and servo-motor are on another. This model meets U. S. Navy and Air Force specifications for electronic equipment.

**FEATURES:** ➤ Zero waveform distortion.

- High accuracy.
- Independent of load.
- No power-factor restrictions.
- Tolerates short-duration overloads.
- Adjustable output voltage.
- High efficiency.
- High response speed.
- High power capacity.

The oscillograms below show traces of 60-cycle voltage sine-wave peaks illustrating the response speed of the TYPE 1570 Line Voltage Regulator. (a) Left, 2% change (step function) in voltage input to regulator; (b) center, voltage output of regulator as a result of 2% input voltage change shown in (a); (c) right, voltage output of regulator as the input voltage is changed 1%.

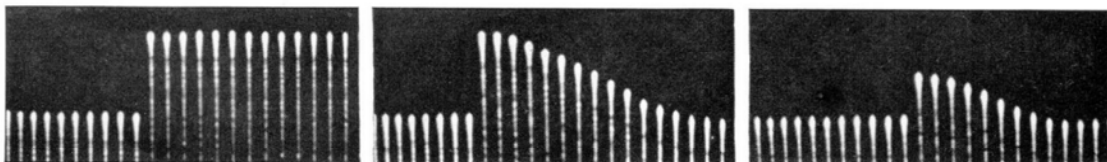



SPECIFICATIONS

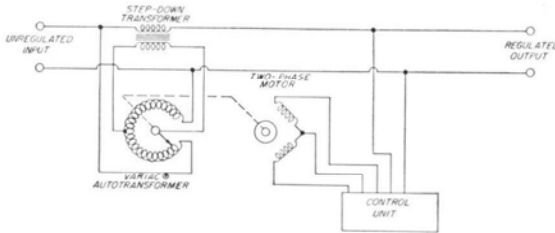

Elementary schematic diagram of the TYPE 1570 Line Voltage Regulator.

**Input Voltage Range:** The desired output voltage will be maintained if the input voltage does not vary by more than  $\pm 10\%$  from this value of output voltage. A  $\pm 20\%$  range connection is also available.

**Output Voltage:** Adjustable over a range of  $\pm 10\%$  from a base value of 115 volts (for TYPE 1570-AL) or 230 volts (for TYPE 1570-AH) by means of a screw-driver adjustment on panel.

Output Voltage	115 Nominal Adjustable $\pm 10\%$		230 Nominal Adjustable $\pm 10\%$	
	90% to 110%	80% to 120%	90% to 110%	80% to 120%
Input voltage as a percentage of output voltage*				
Output current amperes	50	25	20	10
KVA	6	3	5	2.5
Accuracy in % of output voltage	0.25%	0.5%	0.25%	0.5%
Speed of Response volts per second†	10	20	20	40

\* Types 1570-AL and 1570-AH can be connected for either  $\pm 10\%$  or  $\pm 20\%$  input voltage range. Instruments are shipped connected for  $\pm 10\%$  range unless 20% range is specified on order.  
† Slightly less for very small voltage corrections.

**Tube Complement:** 2-12AX7's, 1-5651, 2-5727's.

**Terminals:** Two 15-ampere panel cords, supplied with the instrument may be used to connect the regulator when it is used as a portable instrument. Terminals are easily accessible when other connections are desired.

**Waveform Distortion:** None.

**Accessories Supplied:** Rack and table models — 2 power cords, spare fuses; wall models — cabinet, cover, and mounting screws.

**Waveform Error:** The average value of the output voltage is held constant, and a loaded d-c power supply operated from the output of the regulator will give

constant output voltage regardless of the harmonic distortion present in the power line. The rms output voltage will also remain constant, regardless of the harmonic distortion present, as long as the phase and amplitude of these harmonics are constant. If the harmonic content changes, the rms value will change by an amount less than  $\Delta R/n$ , where  $\Delta R$  is the change in the harmonic amplitude and  $n$  is the harmonic number.

**Ambient Temperature:** Full ratings apply up to 40°C.

**Frequency:** 60-cycle models will operate from 55 to 65 cycles; 50-cycle models, from 45 to 55 cycles.

**Power Consumption:** No Load 35 watts  
Full Load 100 watts

**Mountings:** Relay Rack (-R model), Table top (-M model) and Wall (-W model).

Dimensions:	Rack and Table Top Models		Wall Models
	Width.....	19 in.	13½ in.
Height.....	7 in.	19½ in.	
Depth (over-all)....	12¾ in.	8¾ in.	
Depth (behind panel)	11¾ in.		
Weight.....	56½ lb.	63½ lb.	

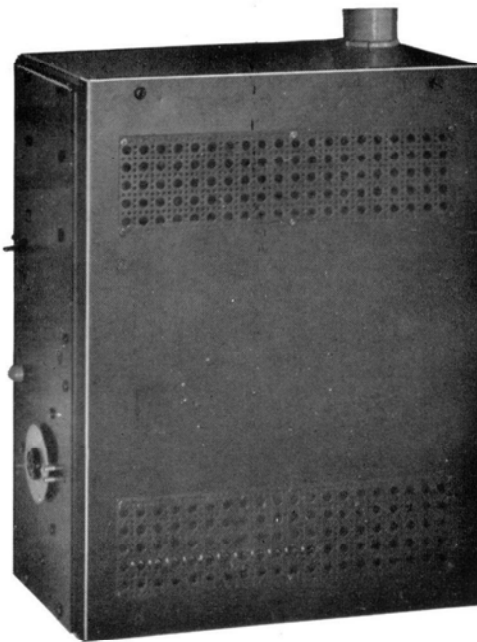

View of wall-mounted regulator. This model is used to regulate line voltages in the General Radio development and testing laboratories.

Type	Description	Code Word	Price
1570-ALM	Table Top Model, 115 volts, 60 cycles . . .	CEDAR	\$465.00
1570-ALR	Relay Rack Model, 115 volts, 60 cycles . . .	CHARY	465.00
1570-ALW	Wall Model, 115 volts, 60 cycles . . . . .	CLOWN	465.00
1570-AHM	Table Top Model, 230 volts, 60 cycles . . . .	CHALK	465.00
1570-AHR	Relay Rack Model, 230 volts, 60 cycles . . .	CURLY	465.00
1570-AHW	Wall Model, 230 volts, 60 cycles . . . . .	CLOSE	465.00
1570-ALQ6 *	115 volts, 50 cycles . . . . .	PASHA †	480.00
1570-AHQ11 *	230 volts, 50 cycles . . . . .	REGAL †	480.00

\* Insert M, R, or W, for table, relay-rack, or wall model, respectively.

† Suffix; add to code word for corresponding 60-cycle model, i.e., CEDARPASHA for Type 1570-ALMQ6.

\* PATENT NOTICE. See Note 8, page viii.



**FOR OPERATING D-C MOTORS FROM A-C LINES**

VARIAC Speed Controls are compact, high-performance motor speed controls, designed to operate d-c shunt, compound, or series motors from an a-c line. The motors are operated with constant field excitation and adjustable armature voltage, obtained from a Variac autotransformer and rectifier, so that shunt motor regulation characteristics are obtained.

*No electronic tubes are used in these controls.* Rectifiers are selenium types, so there is no time delay in starting

Variac® Motor Speed Controls are available in six power ratings: 1/15, 1/6, 1/3, 3/4, 1, and 1 1/2 horsepower. They are simple and rugged, have good regulation, and are particularly suited to shop installation. They have given excellent performance in a wide variety of laboratory, machine-tool, and industrial applications.

For each size motor speed control, a basic model is available for assembly into other equipment. These are identified by the suffix W in their type numbers. These models include the basic components of the mounted controls, but switching and, except for the 1- and 1 1/2-models, overload protection must be supplied by the user.

Figure 1 is the basic circuit for the motor speed controls. Two sets of full-wave rectifiers are used. One set supplies fixed field voltage; the other a continuously adjustable armature voltage, controlled by a Variac autotransformer.

The choke in the armature circuit, in conjunction with the full-wave selenium rectifier, assures continuous conduction throughout the a-c cycle, providing a low-impedance source of essentially ripple-free armature current.

Armature overload protection is accomplished with slo-blow fuses in the 1/15th and 1/6 hp-models, with magnetic circuit breakers

in the 1/3 and 3/4 hp models, and with thermal circuit breakers in the Variac in the 1 and 1 1/2 hp models.

The appliance-type switch supplied with the TYPE 1700-B and TYPE 1702-A controls is available as a separate item, the TYPE 1702-P3 Switch, to use with the W-Models. This switch has enough contacts to break the a-c and d-c circuits simultaneously, and also to handle reversing and dynamic braking. The drum switch supplied with the TYPE 1704-B and the TYPE 1705-B, which is particularly suited for machine-shop production work, is also available as a separate item for use with the W-models.

Type		Code Word	Price
1702-P3	Switch.....	FLIPO	\$ 6.00
1705-P1	Drum Controller.	DRUMO	22.00

The various units, with specifications, are described on the following pages.

Variac Motor Speed Controls offer:

- Smooth Wide-Range Speed Control — 15:1 for most applications; up to 100:1 or more with light or smooth loads.
- Versatile Starting Characteristics: Smooth, controlled starting for delicate loads; fast high-torque starting for heavy loads.
- Dynamic braking in all models 1/6 hp and higher brings the armature to a quick stop.
- Instant Starting.
- Quick Reversing.
- Negligible A-C Ripple — Motor need not be derated — No torque pulsation.
- Low First Cost.
- Very low maintenance. No electronic tubes.
- Simple installation.

PATENT NOTICE. See Note 8, page viii.

FIGURE 2. Speed-Torque Characteristics of a typical motor and speed control installation.

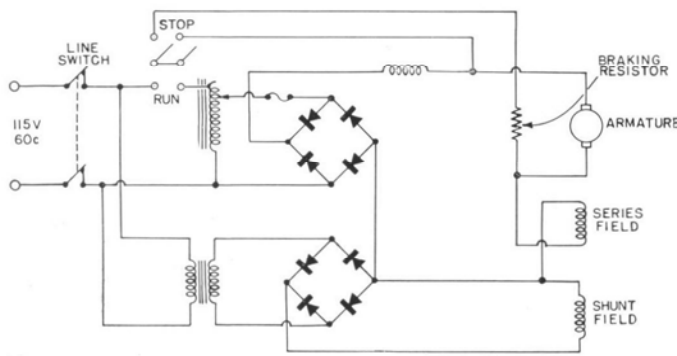
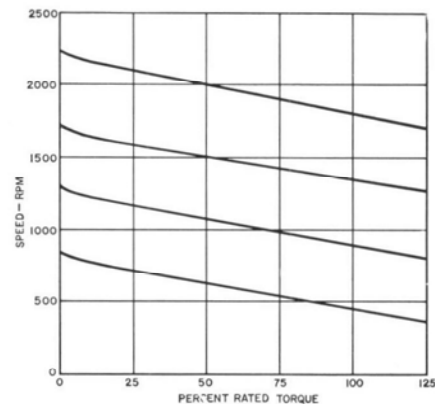

FIGURE 1. Circuit diagram of a Variac Motor Speed Control.





**TYPE 1701-AK AND 1701-AM**

For shunt motors, 1/15 hp and below. Typical applications are: Feed drives for lathes, milling machines, grinders and punch presses; rewinding and take-up drives; jewelers' lathes and other very light machinery; photographic and other processing equipment. — AK model has two speed ranges; — AM model has one, and armature fuse is accessible from front panel.

**TYPE 1701-AU**

Like TYPE 1701-AK, but for series and universal motors. One speed range. Gives shunt regulation characteristics with inexpensive universal motor at speeds up to 10,000 rpm. Motor field and armature leads must be separate.

Applications similar to TYPE 1701-AK, but including also higher speed applications, such as small, very high-speed drill presses.

**TYPES 1701-AKW AND 1701-AUW**

Basic models of the 1/15-hp controls. These contain the essential elements such as the choke, rectifiers and transformers mounted on a chassis, and the Variac supplied as a

separate unit to be mounted by the customer. No switches or overload protection are supplied. They may be chosen by the customer to suit his applications.

Type	Model	D.C. Field	Speed	Code Word	Unit Price	Recommended Motor
1701-AK	Complete in Cabinet	115 v.	0-rated	WINDY	1-4 \$80.00	MOD-5
1701-AM		38 v.	0-2 x rated	WIDOW	5-19 78.00	MOD-5
1701-AU		115 v.	0-rated	WEARY	20 up 76.00	MOD-4
1701-AKW	Basic (Chassis and Variac)	115 v.	0-rated	SERUM	1-4 67.00	MOD-5
		38 v.	0-2 x rated		5-19 63.50	
1701-AUW		10 v.	0-rated	SHINY	20 up 60.50	MOD-4
		16 v.				

**Input Line:** 105-125 v., 60 c. or 105-120 v., 50 c., 175 watts.

**Armature Output:** 0-115 v. dc, 0.8 a.

**Overload Protection:** Fuses, supplied on complete models only.

**Motors: Mod-5** Shunt, 1/15 hp, 1725 rpm, 10¾ lbs, Code Word MOTOR\*, Price \$35.00.

**Mod-4** Universal, 1/15 hp, 8800 rpm, 3¾ lbs, Code Word MOTOR\*, Price \$18.50.

**Dimensions:** Cabinet Models: 5¾ x 6¾ x 4¾ inches, over-all.

Basic Models: Chassis 6⅛ x 9 x 2¾ inches, Variac 3¼ x 3⅛ x 4⅜ inches.

**Weight:** Cabinet Models: 6 pounds.

Basic Models: Chassis 2¼ pounds, Variac 3½ pounds.



Type 1701-AK

**TYPE 1703-A (1/6 hp),  
TYPE 1700-B (1/3 hp), AND  
TYPE 1702-A (3/4 hp)**

These fractional horsepower models are completely assembled with switching and control elements on the face of the cabinet. Typical applications include feed and spindle drives, winding machines, grinders, drill presses, conveyors, and processing machinery.

**W-MODELS (TYPES 1703-BW,  
1700-CW, AND 1702-BW)**

Basic models of the 1/6 to 3/4 hp controls, these models have the essential elements, including the braking resistor, mounted on a simplified chassis with cover. The VARIAC is supplied separately to be mounted by the customer. A suitable switch or drum controller can be supplied (see page 220).

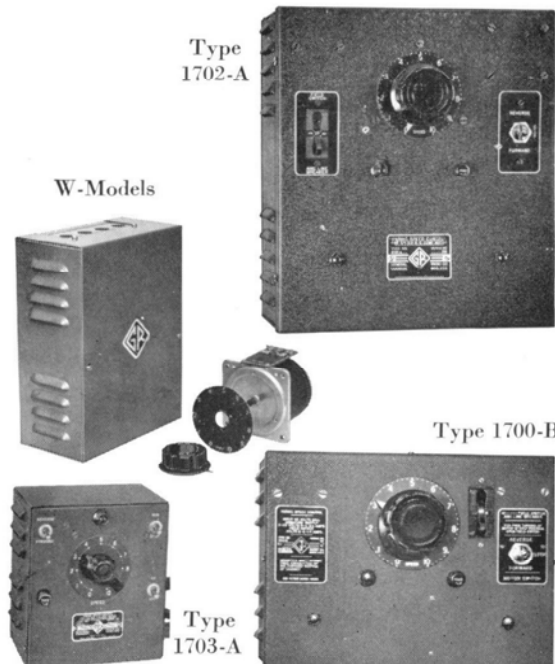

Type 1702-A

W-Models

Type 1700-B

Type 1703-A



Type	Model	D.C. Field	Speed	Code Word	Price			Recom- mended Motor
					1-4	5-19	20-up	
1703-A (1/6 hp)	Complete in Cabinet	115 v.	0-rated	WEBBY	\$97.50	\$94.50	\$91.50	MOD-11
		66 v.	0-1 1/4 x rated					
		48 v.	0-1 1/2 x rated					
1700-B (1/3 hp)		115 v.	0-rated	AFOOT	170.00	166.00	162.00	MOD-3
		75 v.	0-1.15 x rated					
1702-A (3/4 hp)		115 v.	0-rated	AMAZE	245.00	235.00	225.00	MOD-6
	75 v.	0-1.15 x rated						
1703-BW (1/6 hp)	Basic (Chassis with cover, and Variate)	115 v.	0-rated	SABOT	85.00	82.50	80.00	MOD-11
		66 v.	0-1 1/4 x rated					
		48 v.	0-1 1/2 x rated					
1700-CW (1/3 hp)		115 v.	0-rated	SALTY	145.00	141.50	138.00	MOD-3
		75 v.	0-1.15 x rated					
1702-BW (3/4 hp)		115 v.	0-rated	SATIN	205.00	196.00	187.00	MOD-6
	75 v.	0-1.15 x rated						

**Input Line:** 105-125v., 50-60c., 275 watts, for 1/6 hp. 105-125 v., 60 c., 560 and 1150 watts for 1/3, and 3/4 hp respectively (50 c available on special order).

**Armature Output:** 0-115 v., dc at 1.5, 3.0 and 6.5 amps for 1/3, 1/6 and 3/4 hp respectively.

**Overload Protection:** Fuses in 1/6 hp and magnetic circuit breakers for 1/3 and 3/4 hp complete controls only.

**Motors:** Mod-11, 1/6 hp Compound, 1725 rpm, 25 lbs, Code Word MOTOR\*, Price \$52.50.

Mod-3, 1/3 hp Compound, 1725 rpm, 30 lbs, Code Word MOTOR\*, Price \$59.00.

Mod-6, 3/4 hp, Compound with interpoles, 1725 rpm, 60 lbs, Code Word MOTOR\*, Price \$100.00.

**Dimensions and Weight:** 1703, Cabinet Model 7 1/8 x 7 3/4 x 4 5/8, 9 lbs, Basic Model, Chassis 7 1/2 x 10 1/4 x 3 1/2, 4 1/2 lbs, Variac 3 1/4 x 3 1/16 x 4 3/8, 3 1/2 lbs.

1700, Cabinet Model 12 7/8 x 9 3/8 x 6, 23 1/2 lbs, Basic Model, Chassis 9 3/4 x 12 5/8 x 5, 17 lbs, Variac 4 1/2 x 4 15/16 x 5 1/2, 6 1/2 lbs.

1702, Cabinet Model 13 1/2 x 15 1/2 x 6 1/2, 41 lbs, Basic Model, Chassis 11 1/4 x 15 1/4 x 5 7/8, 27 1/2 lbs, Variac 5 3/4 x 6 1/4 x 5 7/8, 11 1/4 lbs.

**TYPES 1704-B (1 hp) AND 1705-B (1 1/2 hp)**

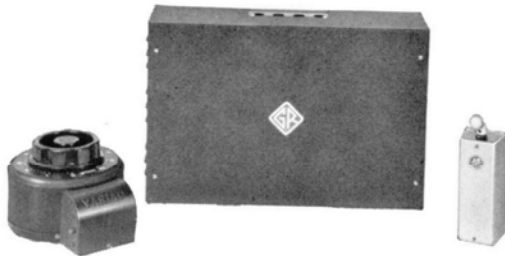

Each of these types is a complete control system with separate covered chassis, Variac and drum controller. -BW models are identical with -B models except that controller is not furnished.

Type	Model	D.C. Field	Speed	Code Word	Unit Price			Recom- mended Motor
					1-4	5-19	20 up	
1704-B (1 hp)	Chassis, with cover, Variate, and Controller	230 v. 160 v. 128 v.	0-rated 0-1.12 x rated 0-1.25 x rated	WEEDY	\$330	\$316	\$302	MOD-9
1705-B (1 1/2 hp)				WAXER	380	365	350	MOD-10
1704-BW (1 hp)	Chassis, cover, and Variate	230 v. 160 v. 128 v.	0-rated 0-1.12 x rated 0-1.25 x rated	SAVOR	308	294	280	MOD-9
1705-BW (1 1/2 hp)				SAXON	358	343	328	MOD-10

**Input Line:** 210-250 v., 60 c. and 50 c., 1500 and 1950 watts for 1 and 1 1/2 hp respectively.

**Armature Output:** 0-230 v. dc, 4.5 and 6 amps for 1 and 1 1/2 hp respectively.

**Overload Protection:** Circuit breaker in Variac.

**Motors:** Mod-9, 1 hp, Compound with interpoles, 1750 rpm, 75 lbs, Code Word MOTOR\*, Price \$185.00.

Mod-10, 1 1/2 hp, Compound with interpoles, 1750 rpm, 87 lbs, Code Word MOTOR\*, Price \$210.00.

**Dimensions (for both types):** Chassis 20 1/2 x 13 3/8 x 5 5/8, Variac 7 7/8 x 5 11/16 x 9 11/16, Controller 3 x 3 7/8 x 9.

**Weights:** 1704, Chassis 38 1/2 lbs, Variac 21 1/4 lbs, Controller 3 lbs.

1705, Chassis 44 1/2 lbs, Variac 21 1/4 lbs, Controller 3 lbs.

\* When ordering control with motor, use compound code word; for example, WINDYMOTOR is the code word for TYPE 1701-AK with motor. Motors are not sold separately.

# WAVEFORM-MEASURING INSTRUMENTS

The choice of an instrument for evaluating the components of a complex electrical signal, an acoustic noise, or a mechanical vibration depends upon the character of the signal, the information that is needed, and how the results are to be used. For example, if the wave is a periodic one that is stable in frequency, each individual component is readily measured with the TYPE 736-A Wave Analyzer. The very high selectivity of this analyzer with its 4-cycle bandwidth is independent of the frequency to which the analyzer is tuned, because the analyzer is a heterodyne type. This selectivity characteristic, obtained by quartz-crystal filters, is invaluable in the measurement of intermodulation distortion of amplifiers and other audio equipment. As an electronic voltmeter in the measurement of the transmission characteristics of electrical wave filters and as a null detector for impedance bridges, the excellent selectivity is of particular value in avoiding the effects of interfering signals, hum, noise, and distortion products.

The TYPE 760-B Sound Analyzer described in the section on Sound and Vibration, whose bandwidth is a constant percentage of the frequency to which its dial is set, finds its greatest use in the measurement of the components of noise, either electrical or acoustical, when the selectivity of the TYPE 736-A Wave Analyzer is often too great for rapid analysis, and in the measurement of noises whose frequency components fluctuate.

Although its tuning is continuous, if one assumes that the analyzer separates its range from 25 to 7500 cps into contiguous bands, according to its effective bandwidth, it will have about 190 bands without appreciable overlap, as contrasted with about 1500 bands for the same range with the wave analyzer. The TYPE 762-B Vibration Analyzer is a similar unit for lower frequencies. Its range from 2.5 to 750 cps is that of greatest interest in the field of vibration.

When a still simpler division of the spectrum is desired, the TYPE 1550-A Octave-Band Noise Analyzer (described in the section on Sound and Vibration) is available for division of the spectrum from 20 to 10,000 cps into eight bands.

The TYPE 1932-A Distortion and Noise Meter is a more specialized, yet remarkably versatile analyzer, designed for the routine and rapid measurements on audio systems. This electronic voltmeter uses the complete signal as a reference value. A selective network suppresses the fundamental component, and the remainder, which includes distortion components, hum and noise, is then measured. This single-number distortion rating is a convenient and frequently used figure of merit of the performance of an audio system.

Used with a cathode-ray oscillograph, it becomes a versatile production testing tool,\* immediately indicating optimum conditions, whenever adjustments are made that affect distortion or noise. Noise, distortion and hum are readily distinguished, and a distinction between second-harmonic and third-harmonic distortion can also be made.

Complete record of the waveform of a signal can be obtained by the use of the TYPE 651 Oscillograph Recorder to photograph the motion of the spot on a cathode-ray oscillograph as the spot is deflected by the electrical wave.

It is sometimes desirable in measurements to be able to improve the waveform of an exciting signal. The TYPE 830-R Wave Filter is available, to isolate a 1000-cycle component. This frequency has been selected because it is the one most commonly used for measurement purposes.

\* W. P. Buuck, "A Simplified System of Wave Analysis for Production Testing," *General Radio Experimenter*, vol. 28, no. 2, July, 1953, pp 1-7.

Type	Name	Class	Frequency Range-cps	Tuning Method	Bandwidth (3 db)	Input Voltage Range	Measurement Application	Power Supply	See Page
736-A	Wave Analyzer	Heterodyne 50-kc. crystal filter	20-16,000	Continuous (1 range)	4 cps	10 microvolts to 300 volts	Separating steady components	A-C Line	224
760-B	Sound Analyzer	R-C Degenerative	25-7500	Continuous (5 ranges)	2% of indicated frequency	1 millivolt to 10 volts	Separating components	Batteries	186
762-B	Vibration Analyzer	R-C Degenerative	2.5-750	Continuous (5 ranges)	2% and 10% of indicated frequency	1 millivolt to 10 volts	Separating components	Batteries	190
1550-A	Octave-Band Noise Analyzer	L-C Filter	20-10,000	Band Switch (8 bands)	2:1	66 db	Broad-Band Noise	Battery	185
1932-A	Distortion and Noise Meter	R-C Rejection	50-15,000 (fundamental)	Continuous (5 ranges)	Rejection band at 60 db = 0.02%	80 db	Harmonic Distortion—Relative Hum and Noise	A-C Line	226
830-R	Wave Filter	Narrow Pass Band	1000	Fixed	10 cps		Filtering 1000 cycle source	None	225
651-AE 651-AH	Oscillograph Recorders	Optical recording on 35 mm film	<i>Film Speed</i> 5-35 fps 25-100 fps	-AH model is also used for high-speed stroboscopic photography.				A-C Line	228

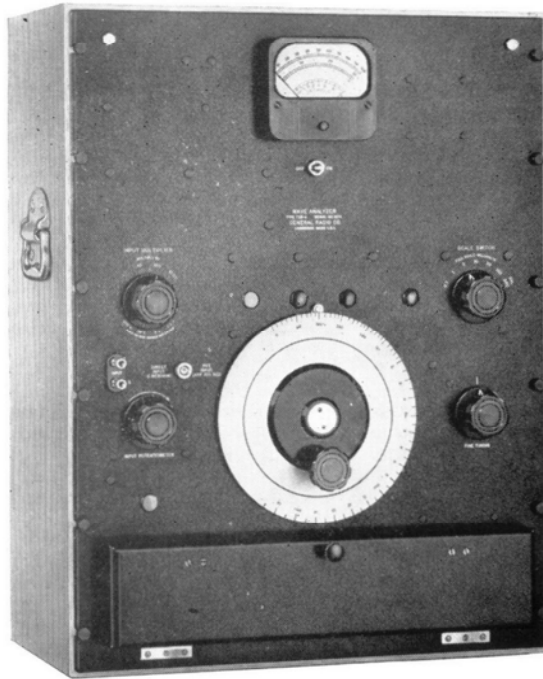

TYPE  
736-A  
WAVE  
ANALYZER

**USES:** The wave analyzer is used to measure the amplitude and frequency of the components of a steady-state complex electrical waveform. These include not only the components of harmonic distortion, but also those of intermodulation distortion, noise, and hum.

Specific uses of the TYPE 736-A Wave Analyzer include the measurement of distortion components in audio-frequency equipment, broadcast receivers and transmitters, telephone systems, public address equipment, oscillators, amplifiers, and vacuum-tube circuits in general; harmonic studies on electric power systems and electrical machinery; hum measurement in a-c operated communication equipment; noise analysis; and induction studies on telephone lines. As a sharply tuned voltmeter, it is invaluable in the measurement of the transmission characteristics of electric wave filters and as a null detector for impedance bridges. It is an excellent detector for intermodulation distortion measurements when the TYPE 1303-A Two-Signal Audio Generator is used as a source.

**DESCRIPTION:** The TYPE 736-A Wave Analyzer is a heterodyne type of vacuum-tube voltmeter. The intermediate-frequency amplifier includes a highly selective filter using three quartz crystals. The use of a heterodyne method makes it possible to vary the response frequency while using a fixed-frequency filter.

The output of the local oscillator and the whole of the complex waveform to be examined are fed to a balanced modulator where their combination produces both the sum and difference frequencies, or side bands, in the output. The original of the complex waveform is not passed by the modulator intermediate-frequency output transformer, and the local-oscillator carrier frequency is suppressed in the output because of the two-tube balanced modulator employed.

The 50-kilocycle component of the upper side band, proportional to the voltage of that frequency present in the original wave to which the main dial is set, is selected and amplified by the intermediate stages. The step attenuators provided make it possible to measure a wide range of voltages.

**FEATURES:** ➤ A "flat top" characteristic as shown by the curve (next page) is obtained by using the three-crystal filter. This feature makes tuning easier and increases the stability of the tuning adjustment.

➤ A very wide range of input voltages — 1,000,000 to 1, full scale — can be accommodated directly.

➤ Self-contained calibrating systems make it possible to standardize the voltage and frequency calibrations easily at any time.

➤ The input impedance is constant at 1 megohm, but a built-in 100,000-ohm potentiometer is provided as an alternate input



system where absolute voltage levels need not be determined.

➤ External magnetic fields cause no trouble because the balanced modulator is fed by a phase inverter tube, rather than by a transformer.

➤ Humidity effects are minimized by the hermetic sealing of all critical parts.

Transmission characteristic of the crystal filter in the TYPE 736-A Wave Analyzer.

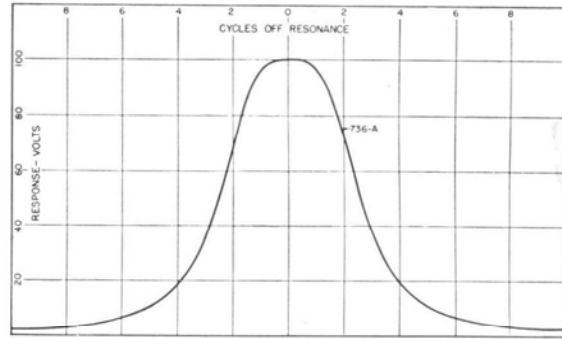

**SPECIFICATIONS**

**Frequency Range:** 20 to 16,000 cycles.  
**Selectivity:** Approximately as shown in plot, above. The response is down 15 db at 5 cycles, 30 db at 10 cycles, 60 db at 30 cycles from the peak. The selectivity is constant over the frequency range.  
**Voltage Range:** 300 microvolts to 300 volts full scale. The lowest division on the meter corresponds to 10  $\mu$ v. The over-all range is divided into four major ranges: 300  $\mu$ v to 300 mv, 3 mv to 3 v, 30 mv to 30 v, 0.3 to 300 v. Each of these ranges is divided into seven scale ranges; for example, the 0.3 v to 300 v range has the following full-scale ranges: 0.3 v, 1 v, 3 v, 10 v, 30 v, 100 v, 300 v.

A direct-reading decibel scale is also provided.  
**Voltage Accuracy:** Within  $\pm 5\%$  on all ranges. Spurious voltages from higher order modulation products introduced by the detector are suppressed by at least 70 db. Hum is suppressed by at least 75 db.

**Input Impedance:** One megohm when used for direct

voltage measurements. When used with the input potentiometer it is approximately 100,000 ohms.

**Accuracy of Frequency Calibration:**  $\pm (2\% + 1 \text{ cycle})$ .

**Tube Complement:**

- 3 — 6C6
- 2 — 6K6-G
- 3 — 6J7
- 1 — 6B8
- 1 — 6C5
- 1 — 6X5-G
- 1 — 6F5-G
- 3 — NE-48 neon lamps

**Power Supply:** A-C line, 105 to 125 volts, 40 to 60 cycles. A change in the power transformer connection permits the use of 210 to 250 volts, 40 to 60 cycles. A voltage-stabilizing circuit is included. Power input is about 65 watts.

**Accessories Supplied:** Spare neon lamps, spare fuses, one TYPE 274-NEO Shielded Connector, and a TYPE CAP-35 Power Cord.

**Mounting:** Shielded oak cabinet.

**Dimensions:** (Width) 19½ x (height) 25½ x (depth) 10¾ inches, over-all.

**Net Weight:** 86¼ pounds.

Type	Code Word	Price
<b>736-A</b>   Wave Analyzer	ASKEW	<b>\$1150.00</b>

PATENT NOTICE. See Note 2, page viii.

For other audio-frequency analyzers, see pages 185 to 190.

**TYPE 830-R WAVE FILTER**

The TYPE 830-R Wave Filter is a sharply-tuned, narrow-band-pass unit, which can be used to eliminate harmonics from distorted waveforms, for isolation of a 1000-cycle component of a complex waveform, and to eliminate spurious-frequency voltages from a 1000-cycle measuring system. Its low attenuation in the pass band makes it particularly useful in 1000-cycle bridge measurements to remove harmonics from the generator voltage.

This filter is sharply tuned for minimum attenuation at 1000 cycles and maximum attenuation at the second harmonic frequency, 2000 cycles. The input and output coils of this unit are tapped so that the filter can be used with different terminating impedances.

It can be operated from a vacuum tube (plate resistance 5000 ohms) or a 500-ohm line into a circuit of almost any impedance with satisfactory results.

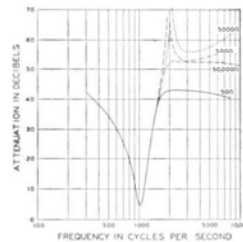

**SPECIFICATIONS**

**Attenuation Characteristic:** See accompanying curve.

**Voltage Limit:** Voltages up to 3 volts at any frequency may be applied to the 500-ohm input, or 10 volts at the 5000-ohm input, without significantly altering the response curves. At higher voltage levels, slight shifts in the frequency of the attenuation peaks may be expected.

**Terminals:** Soldering lugs.

**Dimensions:** (Height) 4½ x (width) 3¾ x (depth) 4 inches overall.

**Net Weight:** 3½ pounds.

Type	Cut-Off Frequency	Impedance	Code Word	Price
<b>830-R</b>	<b>1000 cycles</b>	{ 5000 or 500 $\Omega$ to 50,000, 5000, 500 or 50 $\Omega$ }	FILTERROTE	<b>\$42.00</b>



## TYPE 1932-A DISTORTION AND NOISE METER

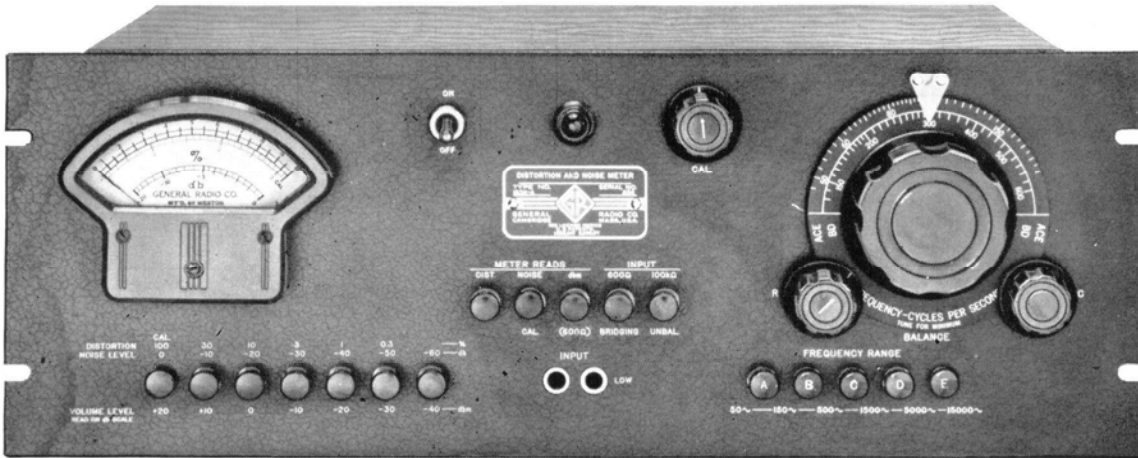

**USES:** The TYPE 1932-A Distortion and Noise Meter measures distortion, noise, and hum level in audio-frequency circuits. In conjunction with the TYPE 1931-A Modulation Monitor, the TYPE 1170-B F-M Monitor or the TYPE 1184-A TV Monitor, it can be used to measure these quantities directly in the output of radio broadcasting transmitters. It finds many uses in the electronics laboratory and in the production testing of radio receivers as a wide-range, highly sensitive voltmeter for such measurements, as signal-to-noise ratio, AVC characteristics, and hum level. With the aid of an oscilloscope, individual hum and distortion components can be identified.

**DESCRIPTION:** The principal elements of the unit are a high-gain amplifier with an R-C interstage coupling unit that balances to a sharp null, a calibrated attenuator for adjusting the sensitivity, and a vacuum-tube voltmeter. Degeneration maintains stability in amplifier gain and a flat transmission characteristic, except within an octave of the null

frequency. The null frequency is continuously variable. The null network eliminates the fundamental of the audio-frequency signal, leaving only the distortion products, which are indicated directly on the panel meter.

The null network is switched out of the circuit for noise and hum measurements, and the instrument then operates as a highly sensitive voltmeter. Two input circuits are provided: (1) a transformer for bridging a 600-ohm line; and (2) a direct connection to the 100,000-ohm gain control.

- FEATURES:**
- Continuous adjustment of frequency over the entire audio range is provided.
  - Quick frequency selection.
  - Frequencies up to 45,000 cycles are passed by the amplifier circuits, so that distortion measurements can be made on fundamental frequencies up to 15,000 cycles.
  - Distortion as low as 0.1% can be measured.
  - An auxiliary dbm calibration is provided.
  - An oscilloscope connection is provided for visual observation of the noise or distortion components.

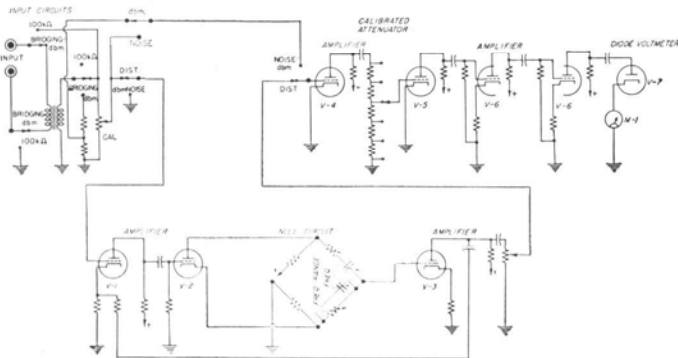

Functional schematic of the TYPE 1932-A Distortion and Noise Meter.



## SPECIFICATIONS

**Distortion Range:** Full-scale deflections for 0.3%, 1%, 3%, 10% or 30% distortion.

**Noise Measurement Range:** 80 db below reference calibration level, or 80 db below an audio-frequency signal of zero dbm level, at maximum sensitivity.

**Audio-Frequency Range:** 50 to 15,000 cycles (fundamental), for distortion measurements; 30 to 45,000 cycles for noise and hum measurements.

**Dbm Range:** Power-level range is from +20 to -60 dbm. (0 dbm is one milliwatt in 600 ohms).

**Input Voltage Range:** 1.2 to 30 volts for the 100-kilohm input, and 0.8 to 30 volts for the 600-ohm bridging input.

**Accuracy:** For distortion measurements,  $\pm 5\%$  of full scale for each range  $\pm$  residual distortion as noted below; for noise and dbm measurements,  $\pm 5\%$  of full scale.

**Residual Distortion Level:**

100-Kilohm Input: 0.05%, max., below 7500 c.  
0.10%, max., above 7500 c.  
Bridging Input: 0.10%, max., between 50 and 70 c.  
0.05%, max., between 70 and 7500 c.  
0.10%, max., above 7500 c.

**Residual Noise Level:** Less than -80 db.

**Input Impedance:** 100,000 ohms unbalanced, and 600-ohm bridging input (10,000 ohms), balanced or unbalanced.

**Meter:** A large meter with an illuminated scale is provided, calibrated in percentage and db. The ballistic characteristic is similar to that of a vu meter.

Type		Code Word	Price
1932-A	Distortion and Noise Meter.....	TABOO	\$620.00
FRI-412	Aluminum End Frames.....	ENDFRAMDIG	13.00 Pair

PATENT NOTICE. See Notes 2, 15, page viii.

## TYPE 1932-P1 A-M DETECTOR UNIT

The TYPE 1932-P1 A-M Detector Unit, for measuring the A-M noise level in F-M transmitters, consists of a linear rectifier and an r-f filter, with provision for introducing an audio-frequency calibrating voltage. The detector output, after filtering, is passed through a standard 75-microsecond de-emphasis circuit to the Distortion and Noise Meter. The de-emphasis circuit can be switched out to give a flat characteristic, if desired. A microammeter indicates the diode current.

Provision is made for the use of an external diode detector to cover ranges of carrier frequency not included in the normal operating range of the self-contained diode detector.

## SPECIFICATIONS

**R-F Input:** 4 to 8 volts required, from low-impedance line, 50-220 Mc.

**Audio Input:** 400 cycles; 4 to 8 volts; 1000-ohm input impedance.

Type		Code Word	Price
1932-P1	A-M Detector Unit.....	AMDET	\$95.00

**Tube Complement:**

4 — 6J5-GT      1 — 6K6-GT      1 — 6X5GT  
1 — 6SN7-GT    1 — 6H6            2 — 0D3

**Accessories Supplied:** TYPE CAP-35 Power Cord, cable for connecting to the TYPE 1931-A Modulation Monitor, spare fuses.

**Other Accessories Required:** For measuring the distortion in oscillators and other audio-frequency sources no additional equipment is required. For measurements on amplifiers, lines, and other communications networks, a low-distortion oscillator is required. TYPE 1301-A Low-Distortion Oscillator (see page 103) is recommended. When the modulated output of a radio transmitter is to be measured, a linear demodulator is necessary. The TYPE 1931-A Modulation Monitor (page 142) or TYPE 1170-B F-M Monitor (page 139) and the TYPE 1184-A TV Monitor (page 140) are recommended. However, any detector system having minimum undistorted output of 1.5 volts rms can be used.

**Terminals:** Terminals are provided at the rear for connection to the modulation monitor. A Western Electric jack is provided at the panel also, as an auxiliary input circuit. Plugging into this jack automatically disconnects the rear connectors.

**Power Supply:** 105 to 125 (or 210 to 250) volts, 50 to 60 cycles. The line input power is 65 watts.

**Mounting:** The instrument is relay rack mounted. End frames are available for table mounting. (See price list below.)

**Panel Finishes:** Standard General Radio black crackle. Certain standard finishes which can be processed in quantity can be supplied.

**Dimensions:** Panel (length) 19 x (height) 7 inches; depth behind panel, 12 inches.

**Net Weight:** 37 $\frac{3}{4}$  pounds.

**Audio Output:**

30-30,000 cycles  $\pm 1$  db; or 75  $\mu$ sec de-emphasis characteristic.

1 to 1.5 volts, into 100 k $\Omega$  load.

**Diode:** 1N34-A Crystal.

**Terminals:** Telephone jack for a-f voltage; coaxial connector for r-f voltage; plug for inserting into panel jacks of Distortion and Noise Meter; telephone jack for external diode detector.

**Accessories Supplied:** 1 TYPE S74-C8 Cable Connector.

**Mounting:** Black wrinkle-finish case.

**Dimensions:** 5 $\frac{1}{4}$  x 6 x 2 $\frac{1}{2}$  inches, over-all.

**Net Weight:** 1 $\frac{1}{2}$  pounds.



## TYPE 651 OSCILLOGRAPH RECORDERS

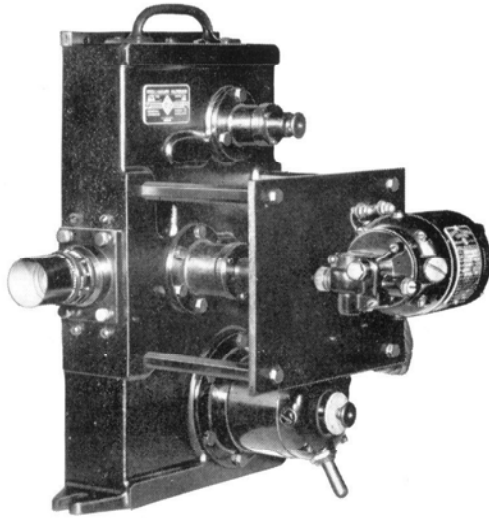

**USES:** These devices are designed for recording the trace of a cathode-ray oscillograph to obtain an accurate record of transient phenomena. Typical applications are the study of the response of electrical networks to sud-

denly applied voltages, the recording of switching transients, and the study of the instantaneous variations of voltages and currents in electrical machinery under arbitrary load variations.

High-speed motion up to several thousand frames per second can be recorded with the TYPE 651-AH, when the subject is illuminated by a high-speed stroboscopic light source.

**DESCRIPTION:** In the TYPE 651-AE and TYPE 651-AH Oscillograph Recorders, the film is driven continually past the aperture, so that the trace of the horizontally deflected cathode-ray spot is recorded as a continuous line.

The large central driving sprocket and a bottom take-up reel are driven by separate motors in the TYPE 651-AE.

The TYPE 651-AH uses a single motor, driving the take-up reel, and an electrical governor on the sprocket shaft. (Note: the photograph above shows the TYPE 651-AE). When the TYPE 651-AH is used for high-speed stroboscopic photography, framing is provided by the stroboscopic light source.

### SPECIFICATIONS

**Film:** Any 35-mm film or paper with standard perforations. Daylight loading with negligible waste.

**TYPE 651-AE:** When motors are operated at the specified voltages, film speeds between approximately 5 and 35 feet per second are obtainable. Motors geared for lower speed ranges can be supplied on special order.

**TYPE 651-AH:** Approximately 25 to 100 feet per second for specified voltages.

**Lens System:** Lens must be purchased separately. A lens of aperture  $f/1.5$  and 2-inch focal length in an adjustable mounting that permits focusing for distances between 8 and 100 inches is available, assembled with mounting plate to fit the recorder. (See price list). The image for focusing is observed directly on the equivalent of a ground glass in the plane of the film. The lens is equipped with an iris diaphragm.

**Oscillograph Screen:** A low-persistence actinic blue screen (P5 or P11 phosphor), should be used.

**Reels:** Capacity of reels, 100 feet.

Flight of a bullet, as recorded by the TYPE 651-AH and a stroboscope at 10,000 flashes per second.

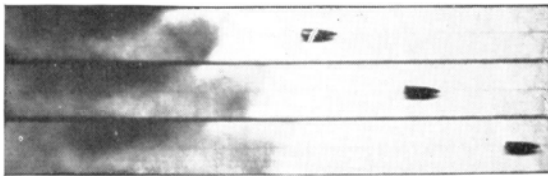

**Drive System:** TYPE 651-AE: Both the film-drive sprocket and the take-up reel are driven by universal (a-c or d-c) motors. The film speed is varied by applying voltages between 65 and 200 volts to these motors.

**TYPE 651-AH:** The take-up reel is driven by a universal motor, whose speed is varied by applying voltages between 65 and 230 volts. An adjustable electric governor controls the sprocket shaft speed.

**Speed Control:** For a-c drive, a W5HMT Variac is recommended; for d-c drive, a rheostat should be used.

**Starting Characteristics:** TYPE 651-AE: Full operating speed is reached in approximately 25 feet of film travel at maximum speed. At lower speeds, less film is consumed in reaching operating speeds.

TYPE 651-AH: Full speed in from 10 to 40 feet.

**Accessories Supplied:** TYPE CAP-35 Power Cord.

Type	Length	Width	Height	Net Weight
651-AE	12 inches	11 $\frac{3}{4}$	16 $\frac{1}{2}$	32 pounds
651-AH	12 inches	8	16 $\frac{1}{2}$	30 $\frac{3}{4}$ pounds

Waveform recorded by TYPE 651-AE from cathode-ray oscilloscope screen.

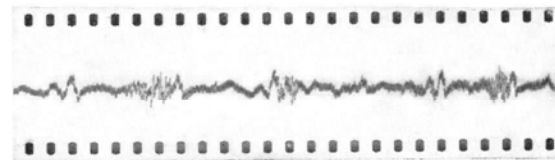

Type		Code Word	Price
*651-AE	Oscillograph Recorder.....	DINER	\$600.00*
*651-AH	Oscillograph Recorder.....	DRYAD	650.00*
651-P5	Lens Assembly, $f/1.5 \times 2.0''$ .....	DIARY	165.00

\* Without lens.  
PATENT NOTICE. See Note 6, page viii.



# PARTS AND ACCESSORIES

The General Radio Company has developed and is constantly improving on a complete line of parts for use in its laboratory and industrial instruments. The design objectives are different from those that govern the design of parts for tv and radio receivers and similar assemblies; among them are unailing reliability, long life, convenience, excellent appearance, and known electrical characteristics. All General Radio parts are painstakingly designed; they use the best available materials; and production is tooled to yield reasonable prices in consideration of the rigid design requirements. Another important design consideration is to produce integrated groups of basic elements that fit together electrically and have a unity of appearance.

An excellent example of the integrated line is found in General Radio binding posts, coaxial elements, plugs and jacks. Binding posts, for instance, are constructed of brass with Bright-Alloy plate. Bright-Alloy is a high-conducting trimetal plating which does not tarnish (it has a lower tarnish rate even than nickel, for example), will not fingermark, and solders as readily as any known material. Polystyrene insulation, in both red and black for color coding, is used because of its high resistivity and exceptionally low loss. The captive top will accept the standard GR TYPE 274 Plug which seats with a taper into the chamfered binding post top to assure mechanical and electrical stability. The insulators are keyed to the binding posts and may be keyed to the panel if desired. They may also be used to mount the TYPE 938 Jack. Both the binding posts and the jack have tips for soldering — no lugs are used as they can introduce an uncertainty of contact.

The TYPE 874 Coaxial Connector, introduced by General Radio a few years ago, has already become an accepted laboratory standard for high-frequency work. An extensive line of coaxial elements using this connector is described in a separate section (Pages 45 to 62). The inner connector is the correct size to accept a TYPE 274 Plug.

The Type 274-MB Double Plug is another connector that has become standard equipment in almost all laboratories. The springs of the plugs, as with all TYPE 274 Plugs, are of hardened beryllium-copper, for low contact resistance, and are molded, for strength, into a black polystyrene body, which has a raised ridge along one side so that polarity can be noted by touch. To reduce the chance of electrical shock, no metal part except the plugs themselves is exposed.

The new TYPE 970 Potentiometers have been designed with particular care to produce an instrument-grade potentiometer at reasonable cost. Care has been taken in the selection of all materials to produce a high

degree of mechanical strength and stability coupled with correct electrical design. For example, the smallest practicable size resistance wire is selected to obtain high resolution. They are wound by specially designed machines to produce uniformity of spacing and tension on the winding form; the wound form is tightly cemented into the bakelite shell molding, which has cylindrical walls of uniform cross-section so that it will not age out of round. Strong shafts made of glass-reinforced polyester are used, so that the shaft is electrically dead, and the capacitance to ground is correspondingly reduced.

The TYPE 1420 Capacitors are of unique design. Both the stator and the rotor sections are made from extruded aluminum stock. The plates are cut from this solid shaped stock by high-precision, ganged circular saws. Thus the complete rotor or stator stack is cut from a homogeneous piece which virtually eliminates the contact resistance inherent in the conventional stock construction. These new capacitors are being introduced into General Radio equipment and are offered for general sale for the first time with this catalog. Their advantages in stability and mechanical strength are obvious; their electrical characteristics are equally good.

The General Radio knobs are well known for their attractive appearances and mechanical excellence. Shaft holes are bored for precision, and all except the smallest are provided with two set-screws. They are available in a variety of models and sizes and are consistent in style with the binding posts.

Dials are designed to the closest mechanical tolerances, and are available for direct drive, friction drive, and gear drive, with a black matte finish to reduce glare and thus to provide even better readability.

The TYPES 941 and 942 Transformers probably provide the best performance of any audio transformers commercially available. The former is a general-purpose impedance-matching transformer for general laboratory work in audio and ultrasonic frequencies. The latter is a high-level output transformer with excellent frequency range and very low distortion. The primary has separate windings so that it may be used in the conventional push-pull circuits or in the recently developed single-ended push-pull circuit. This transformer is an excellent one for hi-fi use where the handling of high peaks of output power without distortion is essential.

The TYPE 578 Transformer is designed specifically for generator or detector isolation in a-c bridge circuits, and has an effective inter-winding capacitance of only 0.3  $\mu\mu\text{f}$ .

## Contents of this Section

	<i>Page</i>
Variable Air Capacitor .....	230
Potentiometers .....	231
Transformers .....	234
Dials .....	236
Knobs .....	238
Plug and Jack .....	239
Binding Posts .....	240
Patch Cords .....	242



## TYPE 1420 VARIABLE AIR CAPACITOR



**USES:** The TYPE 1420 capacitor was developed especially for use in laboratory instruments requiring low dielectric losses, low inductance and resistance, and high mechanical and thermal stability. It is used in the TYPE 1606-A Radio-Frequency Bridge and in the TYPE 874-VC Variable Capacitor.

**DESCRIPTION:** These capacitors are of novel construction. The rotor and stator are each machined from solid, shaped aluminum extrusions of identical alloy. The illustration shows how the one-piece stator also serves as a

frame for the assembly. The ends of the stator are bored to receive concentric split rings, made of thermally stable cross-linked polystyrene. These rings are held in compression by precisely machined clamps of the same alloy as the stator. Vestiges of plates are left in both stator ends and clamps to register with turned grooves on the insulators for precise axial positioning. Threaded ball-bearing cages of plated brass are clamped in the center of the insulating rings, and the rotor is carried by a glass-polyester shaft. The front bearing cage has an integral flange for mounting the capacitor on a panel, and the rear cage has a thin-walled perforated section to which a rotor lead can be soldered. A two-fingered coin-silver spring, permanently affixed to the rotor, makes sliding contact with the rear cage. There is no metallic path through ball bearings to rotor or stator. A solder lug is attached directly to the stator at the rear.

**FEATURES:**

- Low residual inductance and resistance.
- Good linearity.
- Low temperature coefficient.
- Insulated rotor.
- Sealed, long-life bearings.

### SPECIFICATIONS

**Capacitance Range:**

	Nominal		Range for Linear variation
	Max.	Min.	
H	250	16	216 $\pm 5\mu\mu\text{f}$
G	130	14	108 $\pm 5\mu\mu\text{f}$
F	70	13	54 $\pm 5\mu\mu\text{f}$

The rotor-to-ground capacitance is about  $2\mu\mu\text{f}$ , and the stator-to-ground capacitance is about  $6\mu\mu\text{f}$ , for all sizes. The data in the above table are for the capacitor used as a two-terminal device, with rotor grounded. If stator is grounded, maximum and minimum capacitance values will be decreased by about  $4\mu\mu\text{f}$ .

**Linearity:** The variation of capacitance with angle of rotation is guaranteed linear within  $\pm 0.2\%$  of full scale. The angular range of linear variation is  $160^\circ$ .

Typical linearity is better than  $\pm 0.1\%$ .

**Dielectric Losses:** For the grounded-rotor connection, the dielectric losses correspond to a  $D_oC_o$  product of less than  $.01 \times 10^{-12}$ . The rotor-to-ground capacitance has a  $D_oC_o$  product of  $0.1 \times 10^{-12}$ . This loss component is in parallel with the main capacitance only for the grounded-stator connection.

**Insulation Resistance:** Greater than  $10^{11}$  ohms under standard ASTM laboratory conditions ( $23^\circ\text{C}$ , 50% RH).

**Temperature Coefficient of Capacitance:** Approximately  $+.003\%$  per degree C.

**Shock and Vibration:** Will pass shock and vibration tests of MIL-T-945-A.

**Maximum Voltage:** 700 volts peak.

**Inductance:** Approximately 0.006 micro-henry.

**Torque:** 2 ounce-inches maximum.

**Net Weight:** TYPE 1420-F, 4 oz; -G,  $4\frac{1}{2}$  oz; -H,  $5\frac{1}{2}$  oz.

**Dimensions:** See sketch.

Depth behind panel

F  $1\frac{3}{4}$  inches

G  $2\frac{1}{8}$

H  $2\frac{7}{8}$

Shaft Dia.  $\frac{3}{8}$ "

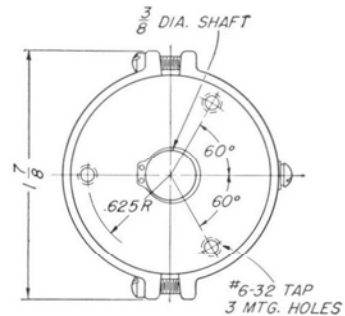

Type	Code Word	Price
1420-F 70 $\mu\mu\text{f}$ , max.....	MARRY	\$20.00
1420-G 130 $\mu\mu\text{f}$ , max.....	MATIN	21.50
1420-H 250 $\mu\mu\text{f}$ , max.....	MAXIM	22.50

See pages 236 to 238 for knobs and dials for use with these capacitors.



## 970 SERIES POTENTIOMETERS

The 970-Series Potentiometers are moderately priced, high-quality controls with performance approaching the best available. They can be used not only at dc, but also throughout the audio- and ultrasonic-frequency ranges and, in many applications, at low radio frequencies.

**DESCRIPTION:** The materials used in the all-phenolic body (1), dust-proof cover (2), and glass-reinforced-polyester shaft (3) minimize the capacitance to ground. Low inductance results from the use of a thin winding form of phenolic laminate. A small-diameter brush (4) of precious-metal alloy assures high resolution, since it touches only two wires at a time on the resistor. Brush arm and spring (8) are combined into a single stamping of spring-temper phosphor-bronze. The screw (10) that holds the cover to the base passes through a horseshoe-shaped slot in the brush arm to serve as a rotational stop that exerts no force on the brush. The brush rides with uniform pressure on the firmly anchored wires at the edge (5) of the resistance winding. The combination of precious-metal contact, firm track and uniform contact pressure minimizes electrical noise.

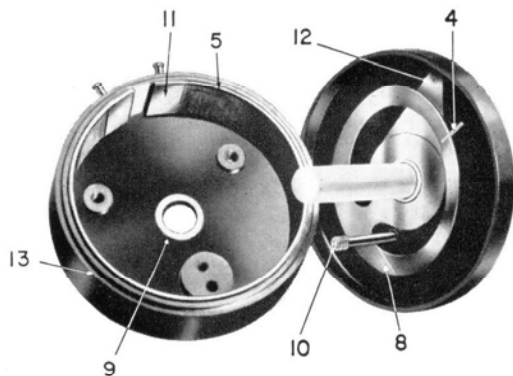

The projecting hub (6) permits adjustment of the shaft with respect to the contact brush while the case is closed. This hub rotates in a reamed brass insert molded into the cover to form a metal-to-metal main bearing close to the plane of the brush. The shaft is rigidly held by this hub, and a second bearing is provided by a stainless-steel insert (9) to guide the shaft in the base. This arrangement provides stable, repeatable settings.

Resistance elements are wound of low-temperature-coefficient alloys. Linearity is assured by uniform turn spacing, on a mandrel that is firmly cemented into the smoothly cylindrical base molding.

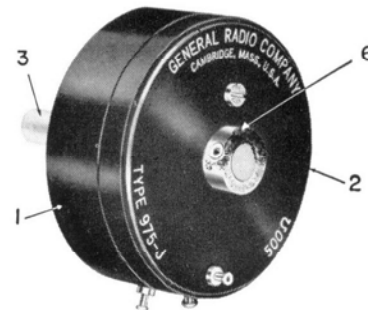

The turret terminals are both riveted and soldered to the ends of the winding (11) and to the spring-bronze contact take-off in the cover (12), so that none of the fixed internal connections depend on pressure alone.

### SPECIAL TYPES

Units in the 970 design can be made on special order with: 360 mechanical rotation, taps as close as  $\frac{1}{4}$  inch apart along the entire winding, resistance other than listed values, resistance tapers, resistance tolerance and linearity tolerances better than standard. For applications requiring maximum shaft rigidity, shafts of metal-cored phenolic or of metal can be supplied.

### GANGING

When ganged, the 970-Series Potentiometers retain their low-capacitance characteristics. Units are designed to be nested with phenolic spacing rings stacked on a long shaft, and held together with thin metal clamping rings and tie rods. This assembly allows units to be set in any desired phase relationship. Inquiries are welcomed on special-design basis.

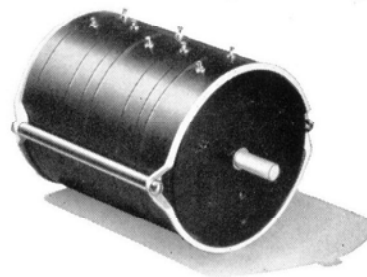

### KNOBS

Recommended knobs for these potentiometers are described on page 238. Use TYPES KNS-6 and KNSP-6 for TYPES 971, 972, 973, and 974; TYPES KNS-8 and KNSP-8 for TYPES 975 and 976; and TYPES KNS-12 and KNSP-12 for TYPES 977 and 978.

Dial plates to fit these potentiometers are listed on page 237.



TYPE 971				TYPE 972				TYPE 973				TYPE 974							
APPROXIMATE WEIGHT		1/2 OZ		APPROXIMATE WEIGHT		3/4 OZ		APPROXIMATE WEIGHT		1 OZ		APPROXIMATE WEIGHT		1 3/4 OZ					
EFFECTIVE ELECTRICAL ROTATION		320 $\pm$ 5°		EFFECTIVE ELECTRICAL ROTATION		320 $\pm$ 5°		EFFECTIVE ELECTRICAL ROTATION		320 $\pm$ 5°		EFFECTIVE ELECTRICAL ROTATION		320 $\pm$ 5°					
TOTAL MECHANICAL ROTATION		330 $\pm$ 5°		TOTAL MECHANICAL ROTATION		330 $\pm$ 5°		TOTAL MECHANICAL ROTATION		330 $\pm$ 5°		TOTAL MECHANICAL ROTATION		330 $\pm$ 5°					
STANDARD RESISTANCE TOLERANCE		±5%		STANDARD RESISTANCE TOLERANCE		±5%		STANDARD RESISTANCE TOLERANCE		±5%		STANDARD RESISTANCE TOLERANCE		±5%					
AVERAGE TORQUE		1 OZ IN		AVERAGE TORQUE		1 OZ IN		AVERAGE TORQUE		1 1/4 OZ IN		AVERAGE TORQUE		1 1/4 OZ IN					
TYPE LETTER	NOMINAL RESISTANCE OHMS	TEMPERATURE COEFFICIENT OF RESISTIVITY	RESOLUTION	STANDARD INDEPENDENT LINEARITY	TYPE LETTER	NOMINAL RESISTANCE OHMS	TEMPERATURE COEFFICIENT OF RESISTIVITY	RESOLUTION	STANDARD INDEPENDENT LINEARITY	TYPE LETTER	NOMINAL RESISTANCE OHMS	TEMPERATURE COEFFICIENT OF RESISTIVITY	RESOLUTION	STANDARD INDEPENDENT LINEARITY	TYPE LETTER	NOMINAL RESISTANCE OHMS	TEMPERATURE COEFFICIENT OF RESISTIVITY	RESOLUTION	STANDARD INDEPENDENT LINEARITY
B	2				C	5	+07%			C	5	+07%			D	10	+07%		
C	5				D	10				D	10				E	20			
D	10		<1%		E	20				E	20				F	50			
E	20				F	50				F	50		<5%		G	100			
F	50				G	100				G	100				H	200			
G	100	±002%			H	200	±002%			H	200	±002%			J	500	±002%		
H	200				J	500				J	500				K	1000			
J	500		<5%	±2%	K	1000				K	1000				L	2000			
K	1000				L	2000				L	2000				M	5000			
L	2000				M	5000				M	5000				N	10,000			
M	5000	+002%			N	10,000	+002%			N	10,000	+002%			P	20,000	+002%		
N	10,000		<2%		P	20,000				P	20,000				Q	50,000			
P	20,000				Q	50,000		<2%		Q	50,000				R	100,000			

Type	Code Word	Unit Price	Type	Code Word	Unit Price	Type	Code Word	Unit Price	Type	Code Word	Unit Price
971-B	ANTRIMBITE	\$3.25	972-C	BANTERCREW	\$3.75	973-C	CANDIDCREW	\$4.00	974-D	DANCERDULL	\$4.50
971-C	ANTRIMCREW	3.25	972-D	BANTERDULL	3.75	973-D	CANDIDDULL	4.00	974-E	DANCEREARL	4.50
971-D	ANTRIMDULL	3.25	972-E	BANTEREARL	3.75	973-E	CANDIDEARL	4.00	974-F	DANCERFALL	4.50
971-E	ANTRIMEARL	3.25	972-F	BANTERFALL	3.75	973-F	CANDIDFALL	4.00	974-G	DANCERGERM	4.50
971-F	ANTRIMFALL	3.25	972-G	BANTERGERM	3.75	973-G	CANDIDGERM	4.00	974-H	DANCERHUNT	4.50
971-G	ANTRIMGERM	3.25	972-H	BANTERHUNT	3.75	973-H	CANDIDHUNT	4.00	974-J	DANCERJUMP	4.50
971-H	ANTRIMHUNT	3.25	972-J	BANTERJUMP	3.75	973-J	CANDIDJUMP	4.00	974-K	DANCERKISS	4.50
971-J	ANTRIMJUMP	3.25	972-K	BANTERKISS	3.75	973-K	CANDIDKISS	4.00	974-L	DANCERLEAP	5.00
971-K	ANTRIMKISS	3.25	972-L	BANTERLEAP	3.75	973-L	CANDIDLEAP	4.25	974-M	DANCERMILK	5.00
971-L	ANTRIMLEAP	3.25	972-M	BANTERMILK	3.75	973-M	CANDIDMILK	4.25	974-N	DANCERNULL	5.00
971-M	ANTRIMMILK	3.25	972-N	BANTERNULL	3.75	973-N	CANDIDNULL	4.25	974-P	DANCERPARK	5.00
971-N	ANTRIMNULL	3.25	972-P	BANTERPARK	3.75	973-P	CANDIDPARK	4.25	974-Q	DANCERQUAD	5.00
971-P	ANTRIMPARK	3.25	972-Q	BANTERQUAD	3.75	973-Q	CANDIDQUAD	4.25	974-R	DANCERRISK	5.00



TYPE 975					TYPE 976					TYPE 977					TYPE 978				
APPROXIMATE WEIGHT 3 OZ. EFFECTIVE ELECTRICAL ROTATION 320±2° TOTAL MECHANICAL ROTATION 330±5° STANDARD RESISTANCE TOLERANCE ±2% AVERAGE TORQUE 3 1/2 OZ. IN.					APPROXIMATE WEIGHT 4 OZ. EFFECTIVE ELECTRICAL ROTATION 320±2° TOTAL MECHANICAL ROTATION 330±5° STANDARD RESISTANCE TOLERANCE ±2% AVERAGE TORQUE 3 1/2 OZ. IN.					APPROXIMATE WEIGHT 9 OZ. EFFECTIVE ELECTRICAL ROTATION 320±2° TOTAL MECHANICAL ROTATION 330±5° STANDARD RESISTANCE TOLERANCE ±2% AVERAGE TORQUE 10 OZ. IN.					APPROXIMATE WEIGHT 12 OZ. EFFECTIVE ELECTRICAL ROTATION 320±2° TOTAL MECHANICAL ROTATION 330±5° STANDARD RESISTANCE TOLERANCE ±2% AVERAGE TORQUE 10 OZ. IN.				
TYPE LETTER	NOMINAL RESISTANCE OHMS	TEMPERATURE COEFFICIENT OF RESISTIVITY	RESOLUTION	STANDARD INDEPENDENT LINEARITY	TYPE LETTER	NOMINAL RESISTANCE OHMS	TEMPERATURE COEFFICIENT OF RESISTIVITY	RESOLUTION	STANDARD INDEPENDENT LINEARITY	TYPE LETTER	NOMINAL RESISTANCE OHMS	TEMPERATURE COEFFICIENT OF RESISTIVITY	RESOLUTION	STANDARD INDEPENDENT LINEARITY	TYPE LETTER	NOMINAL RESISTANCE OHMS	TEMPERATURE COEFFICIENT OF RESISTIVITY	RESOLUTION	STANDARD INDEPENDENT LINEARITY
*D	10				*E	20	+07%			*E	20	+07%			*F	50	+07%		
*E	20				*F	50				*F	50				*G	100		< 2%	±5%
*F	50		< 5%	±1%	*G	100		< 5%	±1%	*G	100		< 2%	±5%	*H	200		< 2%	±5%
*G	100				*H	200				*H	200				*J	500			
*H	200				*J	500				*J	500				*K	1000			
J	500	±002%			K	1000	±002%			K	1000	±002%			L	2000			
K	1000		< 2%		L	2000		< 2%		L	2000		< 1%		M	5000		< 1%	
L	2000				M	5000				M	5000				N	10,000			
M	5000			±5%	N	10,000			±5%	N	10,000				P	20,000			
N	10,000				P	20,000		< 1%		P	20,000			±2%	Q	50,000			±2%
P	20,000	+002%	< 1%		Q	50,000	+002%			Q	50,000	+002%			R	100,000	+002%		
Q	50,000				R	100,000				R	100,000		< 0.5%		T	200,000		< 0.5%	
R	100,000		< 0.5%		T	200,000				T	200,000				U	500,000			

\* NOT USUALLY MANUFACTURED OR STOCKED. INQUIRIES ARE INVITED

Type	Code Word	Unit Price	Type	Code Word	Unit Price	Type	Code Word	Unit Price	Type	Code Word	Unit Price
975-J	EAGLETJUMP	\$4.75	976-K	FANGELKISS	\$5.50	977-K	GANDERKISS	\$6.00	978-L	HAMPERLEAP	\$7.00
975-K	EAGLETKISS	4.75	976-L	FANGELLEAP	5.50	977-L	GANDERLEAP	6.00	978-M	HAMPERMILK	7.00
975-L	EAGLETLEAP	4.75	976-M	FANGELMILK	5.50	977-M	GANDERMILK	6.00	973-N	HAMPERNULL	7.75
975-M	EAGLETMILK	4.75	976-N	FANGELNULL	6.00	977-N	GANDERNULL	6.75	974-P	HAMPERPARK	7.75
975-N	EAGLETNULL	5.25	976-P	FANGELPARK	6.00	977-P	GANDERPARK	6.75	978-Q	HAMPERQUAD	7.75
975-P	EAGLETPARK	5.25	976-Q	FANGELQUAD	6.00	977-Q	GANDERQUAD	6.75	978-R	HAMPERRISK	7.75
975-Q	EAGLETQUAD	5.25	976-R	FANGELRISK	6.00	977-R	GANDERRISK	6.75	978-T	HAMPERTICK	8.50
975-R	EAGLETRISK	5.25	976-T	FANGELTICK	6.50	977-T	GANDERTICK	7.50	978-U	HAMPERULNA	10.00



## TYPE 942-A OUTPUT TRANSFORMER

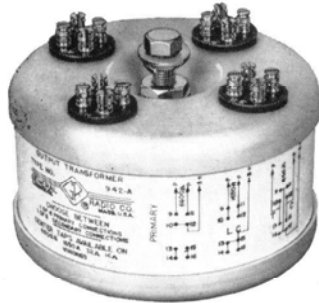

90 WATTS CONTINUOUS RATING

The TYPE 942-A Transformer is a high-level output and impedance-matching unit with excellent frequency response and low distortion. It is suitable for use in the highest-quality sound-reproducing systems, in radio transmitter modulators, and for general use as a high-level step-up or step-down matching transformer.

The low-loss toroidal core carries eight individual windings, giving a wide variety of impedance ratios. All duplicate windings are matched to the nearest turn. Leakage reactance between primary sections is very small, to give minimum distortion from switching transients in conventional push-pull circuits, and connections to individual primaries are provided for the single-ended push-pull amplifier circuit.

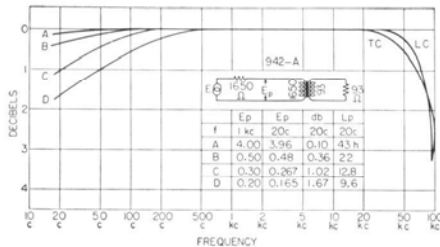

**Primary Impedance:** 6600 ct, 1650 ct, or 413 ohms.  
**Secondary Impedance:** 4, 8, 16 ct, 23, 32 ct, 47, 59, 93 ohms.

**Impedance Transformation Ratios:** 4.42, 7.04, 8.85, 12.89, 17.70, 25.78, 28.16, 35.4, 51.6, 70.8, 103.2, 112.6, 141.6, 206.2, 283.2, 413, 825, and 1650.

**Distortion:** 1% or less at nominal impedance and continuous rated power above 30 cps.

**Power Rating:** 90 watts continuous for 35°C ambient. With d-c, in windings, rating must be reduced so as not to exceed allowable power loss.

**Allowable Power Loss:** 8 watts for 30°C rise.

**Maximum Transformer Temperature:** 65°C.

**Primary Inductance:** Approximately 24 henrys at initial permeability with primaries in series, increases with operating level.

**Insulation:** Tested for 2000 volts between individual windings and between each winding and case.

**Dimensions:** (Height) 3¾ inches x (diameter) 5¼ inches.

**Net Weight:** 7 pounds.

Type	Code Word	Price
942-A	TRANTORDOG	\$65.00

PATENT NOTICE. See Note 1, page viii.

## TYPE 941-A TOROIDAL TRANSFORMER

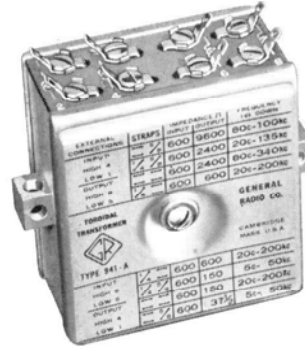

FOR IMPEDANCE MATCHING OR BRIDGING IN  
LOW-LEVEL 600-COMMUNICATION CIRCUITS

This transformer has highly astatic windings and tight coupling. The toroidal core is a spiral of high-permeability-alloy tape. Identical pairs of windings on each half of the toroid minimize pickup and induction field, while close coupling between inner and outer windings keeps leakage reactance low and extends high-frequency response.

**Frequency and Impedance Ranges:** See Table I

**Zero-Signal Inductance:** Inner windings, in series, 5 to 6 henrys; outer windings, in series, 20 to 24 henrys.

**Voltage Matching:** Inner windings, 0.015% or better; outer windings, 0.08% or better.

**Operating Level:** See Table II

**Distortion:** See Table II

**Resistance:** Inner windings, in series, 9 ohms; outer windings, in series, 34 ohms.

**Dimensions:** Aluminum case, 3¾ x 3¼ x 1½ inches. Mounting blocks project ¼ inch beyond case in 3¼ inch dimension. Mounting holes are 3¾ inches on centers and are drilled for clearance with 10-32 machine screws.

**Net Weight:** 13½ ounces.

TABLE I

Terminating Impedances		Frequency for	Flat Insertion
Ω	Ω	1 db drop	Loss Less than
600	9600	80 c — 100 Kc	0.3 db
600	2400	20 c — 135 Kc	0.2 db
600	2400	80 c — 340 Kc	0.2 db
600	600	20 c — 200 Kc	0.1 db
150	600	5 c — 50 Kc	0.7 db
150	600	20 c — 200 Kc	0.2 db
37.5	600	5 c — 50 Kc	0.8 db

TABLE II

Watts	Level		60-cycle r-m-s distortion
	dbm		
1.26	31		<1%
1	30		<0.5%
0.5	27		<0.2%
0.032	15		<0.1%

Type	Code Word	Price
941-A	TRANTORCAT	\$38.00



## TYPE 578 SHIELDED TRANSFORMER

This transformer is used in direct-reading a-c bridges to isolate the bridge circuit from changes in electrostatic potential in the generator (or detector) circuit and to reduce the effect of the capacitance of the external circuit to ground. It can also be used to isolate any measuring circuit from the generator or detector, or to produce a balanced output from a grounded generator.

Three shields are used, one around each winding and a third to bring the core laminations to the potential of the case. The direct capacitance from primary to secondary is less than  $0.3 \mu\text{mf}$ , and the capacitance added across the bridge arms is less than  $80 \mu\text{mf}$ , which is less than the usual generator-to-ground capacitance.

The transformer covers a wide frequency range and can be used either step-up or step-down.



### SPECIFICATIONS

**Turns Ratio:** 4 to 1 or 1 to 4.

**Ranges:** See price table.

**Capacitances:** see drawing.

$C_1, C_2, C_5, C_6$ .....	each $200 \mu\text{mf}$
$C_3$ .....	$0.3 \mu\text{mf}$
$C_7, C_8$ .....	each $70 \mu\text{mf}$
$C_4$ .....	$30 \mu\text{mf}$

**Winding Inductance:** Turns squared (see table) multiplied by  $3.5 \times 10^{-6}$  henries, approx.

**D-C Resistance:** (In ohms) 30 times inductance in henries, approx.

**Voltage Limits:** The high-impedance winding of TYPES 578-A or -B may be connected directly across a 115-volt 50- to 60-cycle line if the impedance connected to the other winding equals or exceeds the lowest value given under "low impedance" in the table below. The TYPE 578-B may be used at 25 cycles under the same conditions.

For TYPES 578-A or -B, the low-impedance winding may be connected directly to a 115-volt, 50- to 60-cycle line provided that the resistance across the high-impedance winding exceeds 10,000 ohms. The TYPE 578-B may be used at 25 cycles under the same conditions.

**Insulation:** The insulation from winding to winding and from windings to case will withstand 1000 volts, peak.

**Dimensions:** Base,  $3\frac{1}{8} \times 2\frac{13}{16}$  inches; height,  $4\frac{1}{8}$  inches.

**Net Weight:**  $2\frac{1}{2}$  pounds.

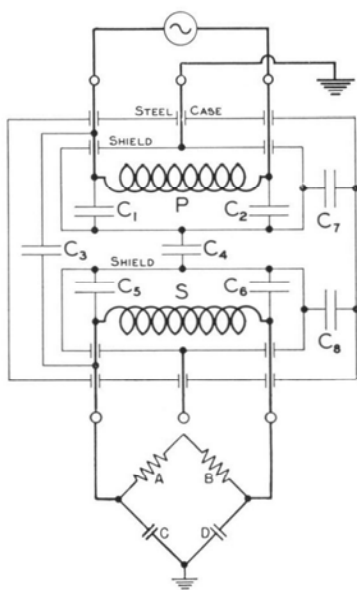

Grounded bridge supplied through a double-shielded transformer. When case is grounded, the capacitance placed across each capacitance arm is  $40 \mu\text{mf}$ . Note that the winding shield on the bridge side is *not* grounded, but is floating.

Type	Turns	Frequency Range*	Impedance Range*		Code Word	Price
			Low-Impedance Winding	High-Impedance Winding		
578-A	600 to 2400	50 cycles to 10 kc	50 $\Omega$ to 5 k $\Omega$	1 k $\Omega$ to 100 k $\Omega$	TABLE	\$25.00
578-B	1000 to 4000	20 cycles to 5 kc	60 $\Omega$ to 6 k $\Omega$	1.2 k $\Omega$ to 120 k $\Omega$	TENOR	25.00
578-C	60 to 240	2 kc to 500 kc	20 $\Omega$ to 2 k $\Omega$	0.4 k $\Omega$ to 40 k $\Omega$	TEPID	25.00

\*These ranges are for transmission within 6 db. At extremes of both impedance and frequency ranges, the transmission may be down by 12 db.



TYPE 908-WB



TYPE 908-WA

### GEAR-DRIVE PRECISION DIALS

The TYPE 907 and 908 Gear-Drive Precision Dials have aluminum dial plates with black anodized finish. Scales are individually engraved on an automatic, self-indexing engraving machine. The radial, accurately located lines divide the complete circumference into 360 divisions numbered from 0 to 360.

Settings can be consistently duplicated to one-fifth of a division, allowing a precision of resetting of better than 0.06% of full scale. Parallax is eliminated by the use of an indicator that always remains flush with the surface of the dial, and which at the same time absorbs, through the flexibility of its mounting arm, any slight eccentricities of the main shaft.

The ring gear and drive pinion are precision-cut gears, spring pressed to eliminate any backlash. The drive ratio is 10:1, and it is possible to use a calibrated vernier or increment dial on the pinion shaft if desired. Any standard TYPE 901 dial (page 237) can be adapted for use on the pinion shaft. The drive pinion is held in a stainless-steel collet, which runs in a phosphor-bronze bushing. The collet allows

the drive to be adjusted for any panel thickness up to  $\frac{5}{16}$  inch.

The main dials are set permanently and securely to their shafts through the use of two set-screws 90° apart; this procedure eliminates any dial backlash that might otherwise occur. The dial hubs are bored to receive a  $\frac{3}{8}$ -inch shaft, but a split bushing is furnished for use with  $\frac{1}{4}$ -inch shafts.

The dial indicator, knob, and all necessary mounting parts are supplied, as are complete drilling and mounting instructions.

**MOTOR DRIVES** — Motor drives for attachment to these dials are described on page 202.

Motor drive attached to a 908-type dial on the TYPE 1304-B Beat-Frequency Audio Generator.

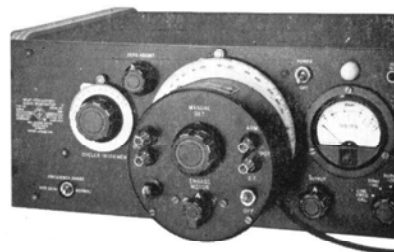

Type	Mounting	Dial		Max. Panel Thickness	Total Panel Area	Net Weight	Code Word	Price
		Arc	Divisions					
<b>➤ 4-INCH DIAMETER GEAR-DRIVE PRECISION DIALS</b>								
907-WA	Front-of-Panel	360°	360	—	4 x 5 inches	11 oz.	DITAB	\$10.50
907-WB	Back-of-Panel	360°	360	$\frac{5}{16}$ inch	4 x 5 inches	11 oz.	DITOP	10.50
<b>➤ 6-INCH DIAMETER GEAR-DRIVE PRECISION DIALS</b>								
908-WA	Front-of-Panel	360°	360	—	6 x 7 $\frac{1}{2}$ inches	21 oz.	DIVAT	\$14.50
908-WB	Back-of-Panel	360°	360	$\frac{5}{16}$ inch	6 x 7 $\frac{1}{2}$ inches	19 oz.	DIVIM	14.50

PATENT NOTICE. See Note 13, page viii.





## FRICION-DRIVE AND DIRECT-DRIVE DIALS



TYPE 904-VF



TYPE 902-TF

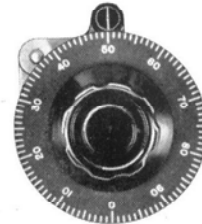

TYPE 901-WD

Approx.  
1/2 size

These dials are attractive in appearance, with accurate, photo-etched scales, and are intended for uses where precisely cut scales and precision drives are not needed. Dial plates are of aluminum, with black anodized finish.

The friction-drive mechanism, which is available on the 2 3/4-inch and 4-inch sizes, consists of a thin disc, which is mounted on the back of the dial plate, gripped and driven by two small discs attached to the friction-drive shaft. The tension of the drive can be easily

adjusted after installation.

Dials are insulated from the shaft. Knobs are secured to their shafts by the use of two setscrews separated by 90° and are supplied bored to receive a 3/8-inch shaft. Bushings are supplied for use on 1/4-inch shafts.

The indicators shown in the photographs are designed to remain flush with the surface of the dial, thus eliminating parallax and absorbing any slight eccentricities of the main shaft. Indicators, mounting screws, drive knobs, and drilling templates are furnished.

Type	Dial		Drive	Net Weight	Code Word	Price
	Arc	Divisions				
<b>➤ 2-INCH DIAMETER — TYPE 901 DIALS</b>						
901-TD	180°	100	Direct	2 oz.	DIALOG	\$2.00
901-VD	270°	100	Direct	2 oz.	DILAP	2.00
901-WD	360°	100	Direct	2 oz.	DILID	2.00
<b>➤ 2 3/4-INCH DIAMETER — TYPE 902 DIALS</b>						
902-TD	180°	100	Direct	2 1/2 oz.	DIMAP	\$2.50
902-VD	270°	100	Direct	2 1/2 oz.	DIMID	2.50
902-TF	180°	100	Friction, 3.3:1	4 oz.	DIMOB	4.00
902-VF	270°	100	Friction, 3.3:1	4 oz.	DIMUG	4.00
<b>➤ 4-INCH DIAMETER — TYPE 904 DIALS</b>						
904-TF	180°	100	Friction, 5:1	8 oz.	DIPEN	\$5.00
904-VF	270°	200	Friction, 5:1	8 oz.	DIPUT	5.00

PATENT NOTICE. See Note 13, page viii.

## DIAL PLATES FOR 970-SERIES POTENTIOMETERS

The 4-inch and 2 3/4-inch sizes are reversible; one side for use as dial plate, with pointer-type knob; the other side for use as dial, attached to knob. The 2-inch size is single side, for dial plate only. Photos show, left to right, dial-plate side of 970-P3, dial side of 970-P2, 970-P1. Scales cover full angle of winding —320°.

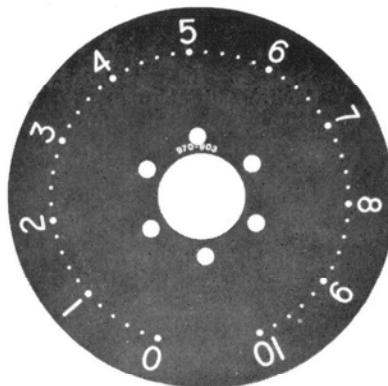

Type	Dia.	Use With Type	Code Word	Price
970-P1	2"	971, 972, 973, 974	DIPAL	\$0.10
970-P2	2 3/4"	975, 976	DIPOT	.20
970-P3	4"	977, 978	DIPUG	.35

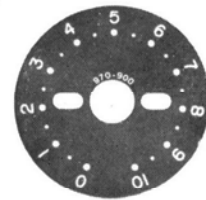
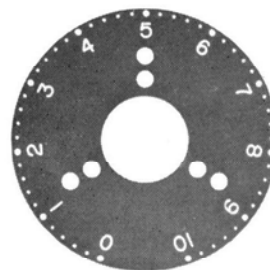



### TYPE KN FLUTED KNOBS

These molded phenolic knobs are used on General Radio laboratory instruments. Each is molded in one piece with a brass insert bored for a 3/8-inch shaft except the TYPE KN5P-1, which is reamed for a 1/4-inch shaft. A bushing is furnished with each of the others to adapt it to a 1/4-inch shaft. Knob is clamped to shaft by two set-screws spaced 90° apart, except in TYPE KN5P-6, which has 135° spacing. TYPE KNB-1 has single set-screw.



TYPE KNB-1

TYPE KNB-2



TYPE KN5P-1



TYPE KN5P-6

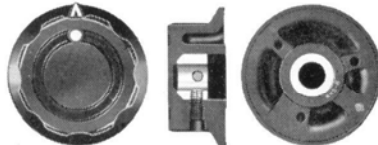

TYPE KN5P-8



TYPE ZKNU-3

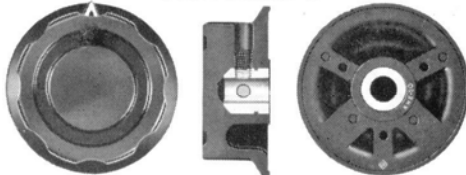

TYPE KN5P-10

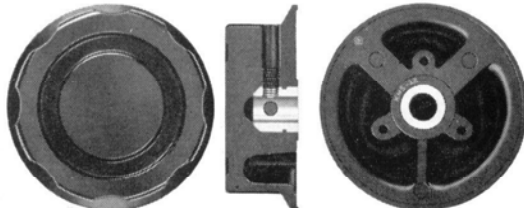

TYPE KNS-12

The TYPE KN Fluted Knobs are shown approximately three-eighths actual size in the photograph.

#### TYPE KNB-1 1 5/16" SKIRT DIA WITH BAR

#### TYPE KNB-2 1 5/16" SKIRT DIA WITH BAR

Bar-Type especially convenient on switches.

Unit Price†	5*-19	20-199	200-399	400-1999	2000 up
TYPE KNB-1	\$0.80	\$0.70	\$0.65	\$0.60	\$0.57
TYPE KNB-2	\$0.85	\$0.75	\$0.70	\$0.65	\$0.60

Code Word: KNB-1, BARKNOBONE Weight for 5: 3 3/4 oz.

Code Word: KNB-2, BARKNOBTWO Weight for 5: 6 oz.

#### TYPE KN5P-1 1 5/16-INCH SKIRT DIA

Unit Price†	5*-19	20-199	200-399	400-1999	2000 up
TYPE KN5P-1	\$0.60	\$0.50	\$0.47	\$0.44	\$0.42

Code Word: NURLNOBDEEN

Net Weight for 5: 6 oz.

#### TYPE KN5P-6 WITH POINTER 1 5/16" SKIRT DIA

#### TYPE KNS-6 WITHOUT POINTER

Unit Price†	5*-19	20-199	200-399	400-1999	2000 up
KN5P-6 or KNS-6	\$0.60	\$0.50	\$0.47	\$0.44	\$0.42

Code Words: KN5P-6, NURLNOBSIX

KNS-6, NURLNOBOUT Net Weight for 5: 5 1/2 oz.

#### TYPE KN5P-8 WITH POINTER 1 5/16" SKIRT DIA

#### TYPE KNS-8 WITHOUT POINTER

Unit Price†	5*-19	20-199	200-399	400-1999	2000 up
KN5P-8 or KNS-8	\$0.70	\$0.60	\$0.57	\$0.54	\$0.52

Code Words: KN5P-8, NURLNOBATE

KNS-8, NURLNOBOAF Net Weight for 5: 8 oz.

#### TYPE ZKNU-3 1 5/16" SKIRT DIA WITH SPINNER

This knob has an auxiliary finger spinner so that knob can be spun rapidly with the index finger. Particularly useful with slow-motion drives.

Code Word: SPINNOBTRE

Net Weight: 2 3/4 oz.

Unit Price \$1.55

#### TYPE KN5P-10 WITH POINTER 2 1/4" SKIRT DIA

#### TYPE KNS-10 WITHOUT POINTER

Unit Price†	5*-19	20-199	200-399	400-1999	2000 up
KN5P-10 or KNS-10	\$0.95	\$0.82	\$0.75	\$0.70	\$0.65

Code Words: KN5P-10, NURLNOBTEN

KNS-10, NURLNOBORB Net Weight for 5: 12 1/2 oz.

#### TYPE KN5P-12 WITH POINTER 2 7/8" SKIRT DIA

#### TYPE KNS-12 WITHOUT POINTER

Unit Price†	5*-19	20-199	200-399	400-1999	2000 up
KN5P-12 or KNS-12	\$1.15	\$1.05	\$0.95	\$0.90	\$0.85

Code Words: KN5P-12, NURLNOBGIG

KNS-12, NURLNOBDOZ Net Weight for 5: 17 oz.

PATENT NOTICE. See Note 13, page viii.

\* Minimum quantity sold. † Net. No further quantity discounts.



PLUGS AND JACKS

TYPE 274 PLUGS AND JACKS

TYPE 274 Plugs and Jacks, originated by General Radio in 1924, are almost universally used in electronics and communications laboratories for connecting equipment in temporary or semi-permanent setups and for connecting plug-in elements in tuning systems and other laboratory instruments. All TYPE 274 Plugs and

Jacks are rated at 15 amperes. Plugs have nickel-plated brass stud, beryllium copper springs. Jacks are nickel-plated brass. These plugs and jacks are designed for positive and reliable contact. The plug seats firmly in the jack so that the plug springs are not depended upon for mechanical stability.



TYPE 274-P PLUG

Furnished with nut and soldering lug.  
Code Word: STANPARCAT

Quantity	Unit Price †
10* - 99	\$0.125
100 - 999	.105
1000 - 1999	.087
2000 - 19999	.085

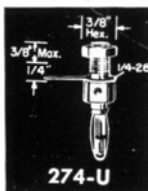

TYPE 274-U PLUG

1/4-28 threaded stud. Jack top accepts TYPE 274 Plug. Code Word: STANPARGOT

Quantity	Unit Price †
10* - 99	\$0.20
100 - 999	.175
1000 - 1999	.165



TYPE 274-J JACK

Fits TYPE 274 Plugs. Nickel-plated brass. Code Word: STANPARTOP

Quantity	Unit Price †
10* - 99	\$0.06
100 - 999	.0495
1000 - 1999	.0468
2000 - 19,999	.044



TYPE 274-SB SHORT-CIRCUIT PLUG

Handy for shorting two terminals. Consists of two TYPE 274-U Plugs connected by two plated links.

Code Word: STANPARZIP Price: \$0.75

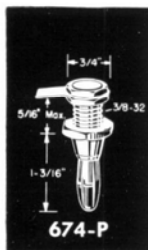

TYPE 674 JUMBO PLUGS AND JACKS

Heavy-duty parts, designed for 35 amperes. Similar in design to TYPE 274, but larger. Nickel-plated brass, with beryllium copper springs. Nuts and soldering lugs included.

TYPE 674-P JUMBO PLUG

Code Word: STANPARAPE

Quantity	Unit Price †
10* - 99	\$0.48
100 - 199	.43
200 - 999	.38

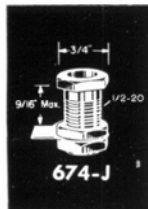

TYPE 674-J JUMBO JACK

Code Word: STANPARAYE

Quantity	Unit Price †
10* - 99	\$0.22
100 - 199	.21
200 - 999	.20

\* Minimum quantity sold.  
† Net prices. No further quantity discounts.

TYPE 274-MB INSULATED DOUBLE PLUG

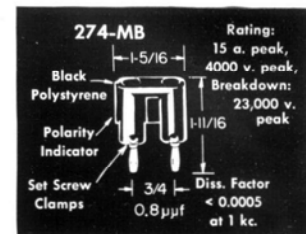

Attractively designed, molded-polystyrene double-plug assembly for rapid and convenient connections in the laboratory. Fits TYPE 938 Binding Post and TYPE 274 Jacks on standard 3/4-inch spacing; jack top permits stacking for multiple connections. Low capacitance, low losses, completely insulated for hand protection, polarity indication molded in.



Code Word: STANPARBUG

Quantity	Unit Price †
5* - 9	\$0.65
10 - 99	.55
100 - 199	.52
200 - 999	.49
1000 up	.47

TYPE 274-DB INSULATED SINGLE PLUGS

Red or black polystyrene-insulated plug with jack top; set screw clamp on plug end for wire or telephone tip.

TYPE 274-DB1 (black) Code Word: STAPLUGANT

TYPE 274-DB2 (red) Code Word: STAPLUGARC

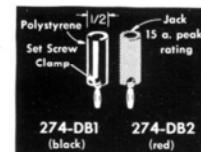

Quantity	Unit Price †
5 - 9	\$0.50
10 - 99	.40
100 - 199	.38
200 - 299	.36
1000 up	.34

TYPE 274-ND SHIELDED DOUBLE PLUG

Double plug in die-case aluminum case for completely shielded connections to a pair of TYPE 938 Binding Posts. Cable entrance to cap is from either side, and polarity indication is provided. Fits TYPE 274-NF Universal Patch Cord (page 242)

Code Word: STARPLUGDOG

Price: \$1.50

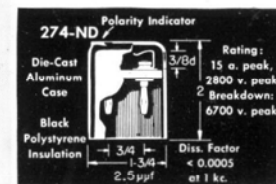
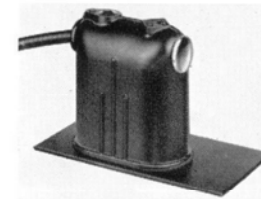



**TYPE 938  
BINDING  
POST  
HAS THE  
ELECTRICAL AND  
MECHANICAL  
PROPERTIES  
NEEDED  
FOR MODERN  
ELECTRONIC  
INSTRUMENTS**

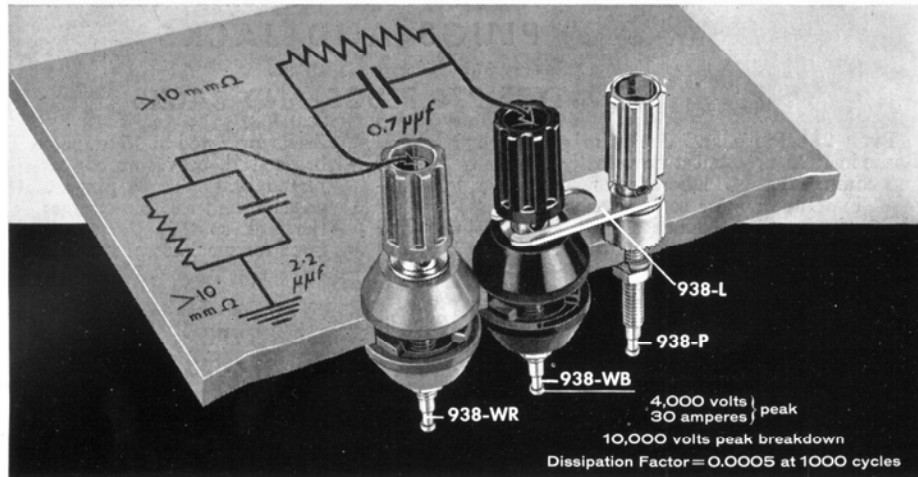

The TYPE 938 Binding Post is designed to meet exacting requirements. It combines excellent electrical properties and ingenious mechanical design. Materials are carefully chosen for their electrical and mechanical properties—brass with Bright-Alloy plate for high conductivity, and polystyrene insulation for high resistance and low power factor, either red or black for color coding. It can be mounted on metal or insulating panels, of a thickness from zero to  $\frac{3}{16}$  inch.

Mechanical details are shown below. The insulators can be keyed to binding post and to panel for positive register.

Six different methods of connection are possible with this assembly (see below). The binding post has the same height above panel as the TYPE 874 Coaxial Connector (see page 61), whose center will take a TYPE 274 Plug, so that a grounded binding post can be mounted adjacent to the coaxial connector to fit a TYPE 274-MB Double Plug.

PATENT NOTICE. See Note 3, page viii.

Type	Code Word	Unit Prices†	100-10*-99	1000-999	2000-9999	10,000 up
938-P Metal top, 938-F Spacer.....	STANPARDOT	\$0.38	\$0.33	\$0.31	\$0.30	\$0.29
938-R Metal top, red Insulators.....	STANPARGIG	.45	.39	.36	.345	.33
938-W Metal top, black insulators.....	STANPARANT	.45	.39	.36	.345	.33
938-WB Black top and black insulators.....	STANPARBAN	.53	.45	.42	.395	.38
938-WR Red top and red insulators.....	STANPARCUB	.53	.45	.42	.395	.38

\* Minimum quantity sold.

† Net prices. No further quantity discounts.

The above binding post combinations are shipped unassembled. When assembly and/or individual packaging before shipment is required, add 5¢ per binding post for each operation.

**METHODS OF CONNECTION**

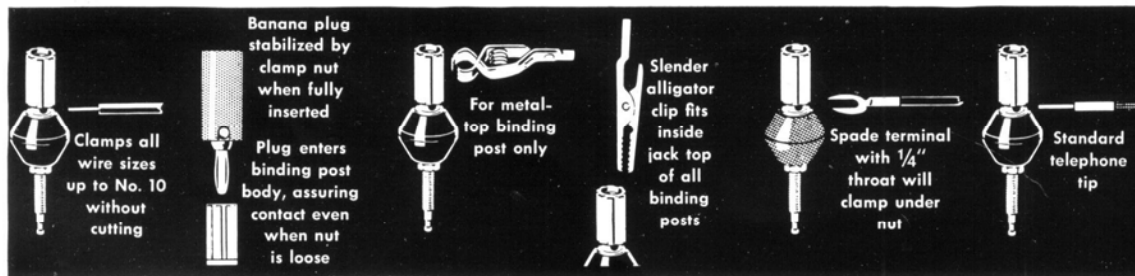

**MECHANICAL DETAILS**

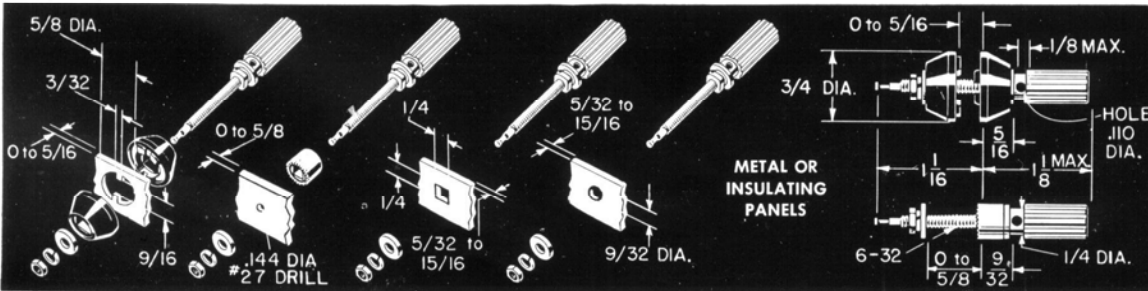

Locking keys in  $\frac{3}{16}$ -inch mounting bobs can be omitted if locking feature is not wanted.



**TYPE 938 BINDING POST—**

Binding posts and insulators are available separately for those who prefer to stock the basic parts and to assemble binding posts as required.

**BASIC PARTS**

The insulators also will mount a TYPE 938 Jack, see below. Both binding post and jack have soldering tips — no lugs are used.

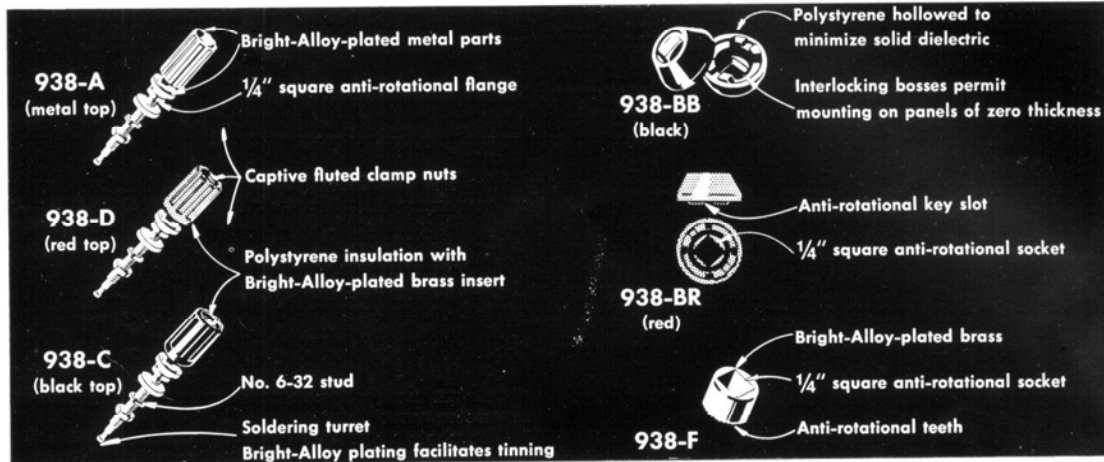

PATENT NOTICE. See Note 3, page viii.

Type	Code Word	Unit Prices†	100-10*-99	100-999	1000-1999	2000-9999	10,000 up
938-A	Metal-Top Binding Post	STANPARASP	\$0.32	\$0.28	\$0.26	\$0.25	\$0.24
938-C	Black-Top Binding Post	STANPARAWL	.40	.34	.32	.30	.29
938-D	Red-Top Binding Post	STANPARARM	.40	.34	.32	.30	.29
938-BB	Black Insulators (Pair)	STANPARAUK	.13	.11	.10	.095	.09
938-BR	Red Insulators (Pair)	STANPARATE	.13	.11	.10	.095	.09
938-F	Spacer	STANPARBON	.06	.05	.05	.05	.05

**OTHER ACCESSORIES FOR TYPE 938 BINDING POSTS  
TYPE 938-Z FLAT INSULATORS**

These insulators mount two binding posts, and are particularly easy to assemble, since 3/4-inch spacing is maintained without exact machining.

Type	Code Word	Price‡ per pair	5*-99	100-999	1000-1999	2000-9999	10,000 up
938-Z	Insulator	STANPARHOD	\$0.175	\$0.165	\$0.155	\$0.145	\$0.14

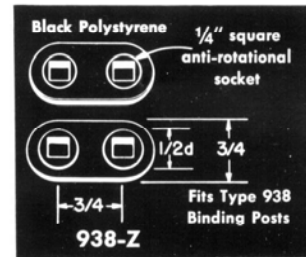

**TYPE 838-B ALLIGATOR CLIP**

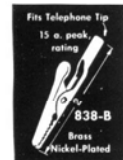

Slender-nose clip that fits inside jack top of all TYPE 938 Binding Posts.

Type	Code Word	Unit Prices†	100-10*-99	200-999	1000 up
838-B	Alligator Clip	STANPARNIP	\$0.15	\$0.14	\$0.13
938-L	Shorting Link	STANPARBET	.10	.09	.085

**TYPE 938-L SHORTING LINK**

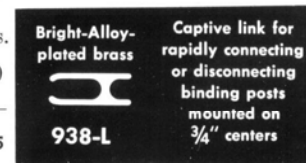

**TYPES 938-J JACK AND 938-X JACK ASSEMBLY**

A jack and jack assembly using TYPE 938-BB Insulators. Jack is similar to TYPE 274-J Jack, but with longer shank. Fits TYPE 274 Plugs.

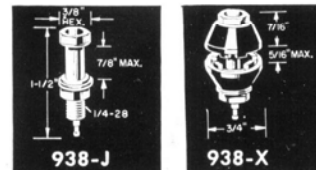

Type	Code Word	Unit Prices†	100-10*-99	100-999	1000-1999	2000-9999	10,000 up
938-J	Jack	STANPARACT	\$0.32	\$0.28	\$0.25	\$0.22	\$0.21
938-XB	Jack Assembly, Black Ins.	STANPARART	.45	.39	.35	.315	.30
938-XR	Jack Assembly, Red Ins.	STANPARHIT	.45	.39	.35	.315	.30

\* Minimum quantity sold. † Net prices. No further quantity discounts.



**TYPE 274-NF UNIVERSAL PATCH CORD**

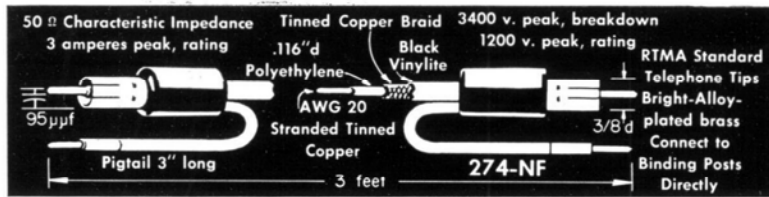

The TYPE 274-NF Patch Cord is the basic unit of an extremely versatile system of connectors. By use of available adaptors and plugs, connections can be made to General Radio TYPE 874-Coaxial Elements, TYPE 938 Binding Posts, and General Radio TYPE 938-B Clips, Army-Navy type N, BNC, C, HN, and UHF coaxial connectors, and VHF and UHF transmission lines are all accommodated through the TYPE 874 Coaxial Adaptors on page 62. These connections can be made with a minimum number of units, permitting maximum flexibility from a given patch cord and connector assortment.

The photograph at the right indicates how the TYPE 274-NF Patch Cord is attached to the TYPE 874-Q6 Adaptor, TYPE 838-B Alligator Clips, the TYPE 274-MB Double Plug, and the TYPE 274-ND Shielded Double Plug.

Type	Code Word	Price
274-NF   Patch Cord	STANPARAGAG	\$1.50

**TYPE 274-NCO PATCH CORD**

The TYPE 274-NCO is a three-foot shielded lead terminated with TYPE 274-MB double plugs.

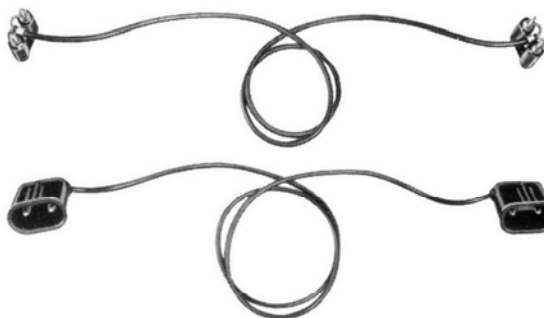

(Above) TYPE 274-NCO  
(Below) TYPE 274-NEO

Type	Code Word	Price
274-NCO   Patch Cord	STANPARZOO	\$3.50

**TYPE 274-NEO PATCH CORD**

The TYPE 274-NEO is a shielded lead, three feet long, terminated with TYPE 274-ND shielded double plugs which are permanently attached.

Type	Code Word	Price
274-NEO   Patch Cord	STAPLUGEYE	\$5.00

**TYPE 874-Q6 ADAPTOR**

Fits TYPE 274-NF Universal Patch Cord to connect TYPE 874 Coaxial system to TYPE 274 banana-plug terminals (page 239).

Type	Code Word	Price
874-Q6   Adaptor	COAXCLOSER	\$1.50

PATENT NOTICE. See Note 4, page viii.

**TYPE CAP-35 POWER CORD**

This is the power cord supplied with General Radio a-c operated instruments; TYPE SJ cord rated by the Underwriters Laboratories at 7 amperes and 300v rms. A high-quality, durable connector, designed for rugged service. Cord is 7 feet long, consisting of two No. 18 stranded conductors, rubber covered. Plug and connector bodies are molded in rubber directly to the rubber sheath of the cable.



(Above)  
TYPE 874-Q6  
Adaptor

(Left)  
TYPE CAP-35  
Power Cord

Type	Code Word	Price
CAP-35   Power Cord	8 oz.   CORDY	\$1.75



## SMITH CHARTS

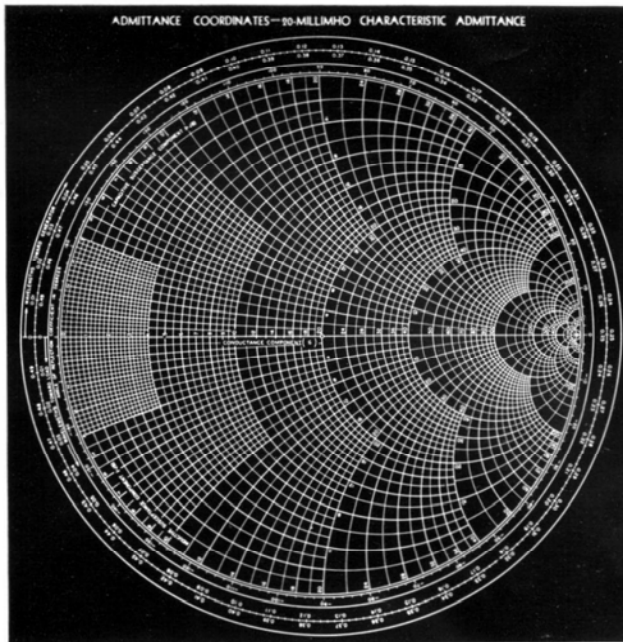

In measurements on transmission-line circuits, it is often necessary to determine, or to correct for, the impedance transformation produced by a length of line. Transmission-line equations can be used to make the calculation, but the process is laborious. A chart with which the calculations can be made graphically with very little effort has been devised by P. H. Smith<sup>1</sup> and is known as the Smith chart. In many cases valuable information can be gained by directly plotting a series of measurements on the chart. In addition to the application indicated above, the chart can be used to determine the VSWR corresponding to any impedance and to convert from impedance to admittance and vice versa. This chart is very useful for measurements using the TYPE 1601-A V-H-F Bridge, TYPE 1602-B U-H-F Admittance Meter, and the TYPE 874-LBA Slotted Line.

Smith charts are usually drawn with normalized impedance coordinates, so that they can be used with lines of any impedance. For work at a single characteristic impedance, a chart reading directly in impedance or admittance is more convenient, because it eliminates the normalizing operation. Four forms of the Smith chart are available, one

<sup>1</sup> *Electronics*, Vol. 17, No. 1, pp. 130-133, 318-325, January 1944.

with normalized coordinates, one with normalized expanded coordinates, one with impedance coordinates (50-ohm characteristic impedance), and one with admittance coordinates (20-millimho characteristic admittance). The 50-ohm characteristic impedance (20-millimho characteristic admittance) is common to all General Radio coaxial equipment. Charts are printed on thin 8½" x 11" paper.

Several copies of the appropriate chart are furnished with the TYPE 874-LBA Slotted Line, the TYPE 874-UB Balun, the TYPE 1601-A V-H-F Bridge, and the TYPE 1602-B U-H-F Admittance Meter. Charts for other applications and additional charts for use with the above instruments can be obtained from General Radio Company at the following prices:

Quantity	Price
50	\$2.00
100	3.75
200	7.00
500	14.00
1000	25.00
2000	47.00

Be sure to specify which type of chart is wanted.

Type	Code Word	Price
<b>Smith Chart—Admittance Coordinates</b> ..... (20-millimho Characteristic Admittance)	ADMITCHART	See Above
<b>Smith Chart—Impedance Coordinates</b> ..... (50-ohm Characteristic Impedance)	IMPEDCHART	See Above
<b>Smith Chart—Normalized Coordinates</b> .....	NORMACHART	See Above
<b>Smith Chart—Normalized Expanded Coordinates</b> .....	EXPANCHART	See Above

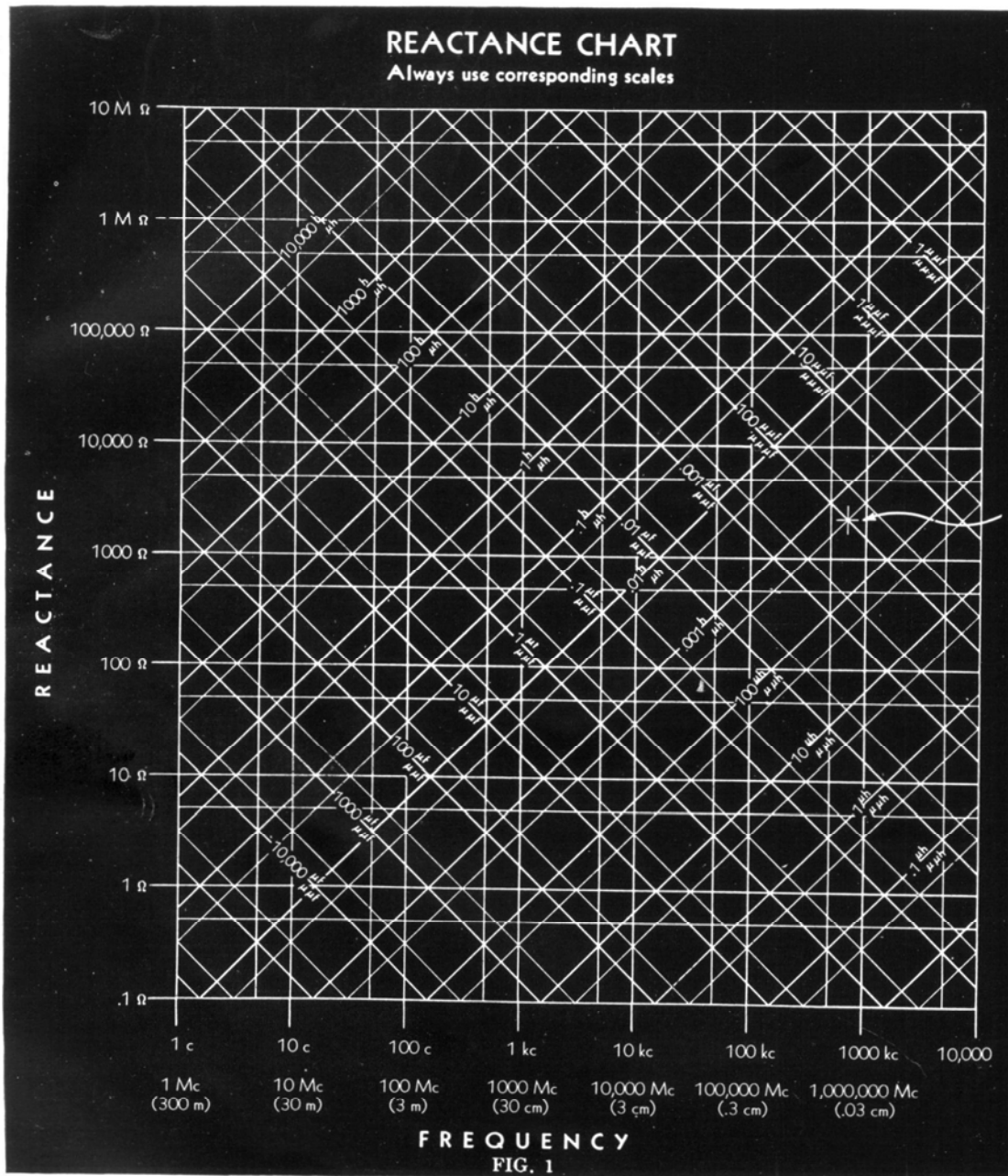

The accompanying chart may be used to find:

- (1) The reactance of a given inductance at a given frequency.
- (2) The reactance of a given capacitance at a given frequency.
- (3) The resonant frequency of a given inductance and capacitance.

In order to facilitate the determination of magnitude of the quantities involved to two or three significant figures the chart is divided into two parts. Figure 1 is the complete chart to be used for rough calculations. Figure

2, which is a single decade of Figure 1 enlarged approximately 7 times, is to be used where the significant two or three figures are to be determined.

**TO FIND REACTANCE**

Enter the charts vertically from the bottom (frequency) and along the lines slanting upward to the left (capacitance) or to the right (inductance). Corresponding scales (upper or lower) must be used throughout. Project horizontally to the left from the intersection and read reactance.

**Write for Enlarged Copies of These Charts**



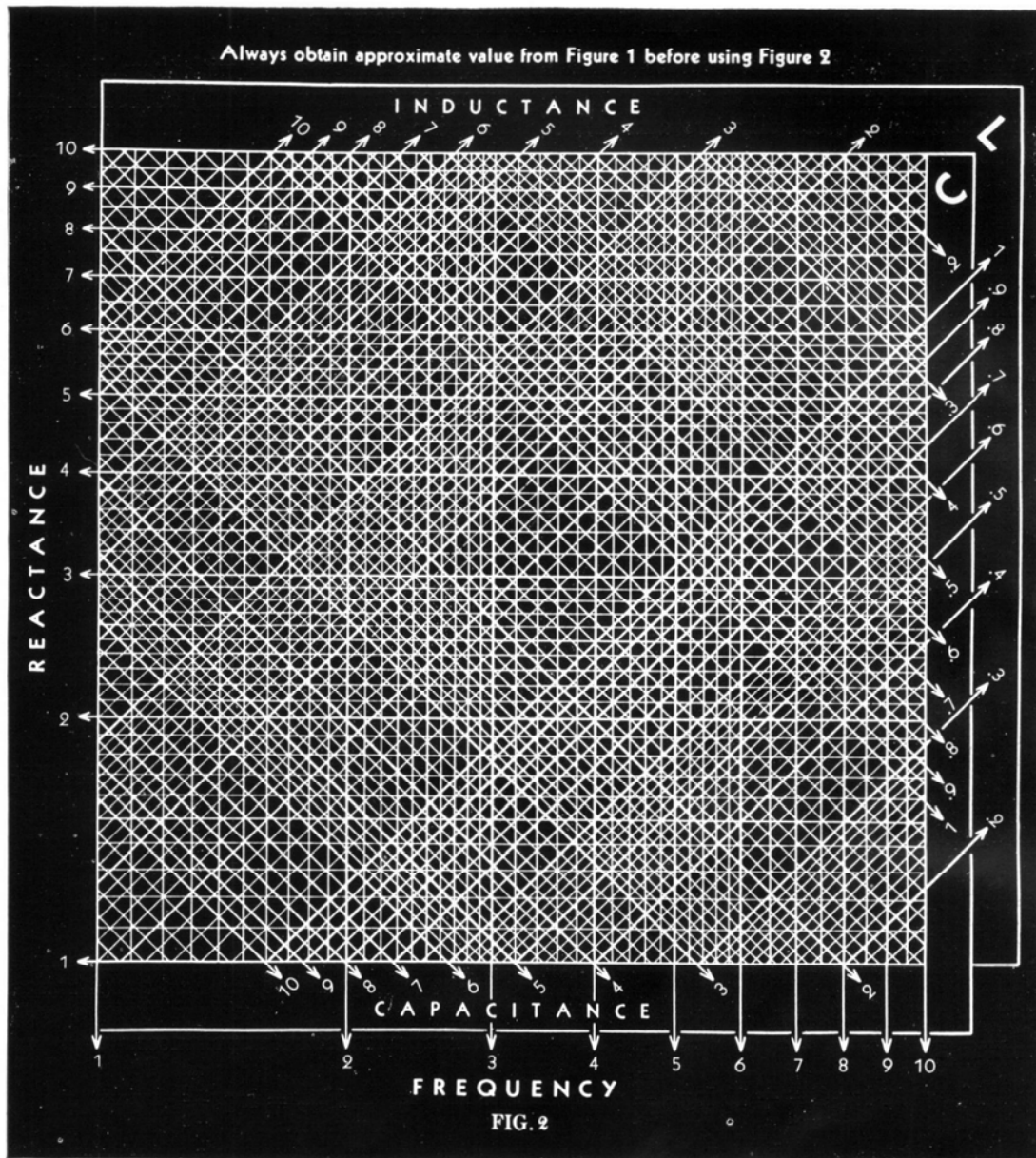

**TO FIND RESONANT FREQUENCY**

Enter the slanting lines for the given inductance and capacitance. Project downward from their intersection and read resonant frequency from the bottom scale. Corresponding scales (upper or lower) must be used throughout.

**Example:** The sample point indicated (Figure 1) corresponds to a frequency of about 700 kc and an inductance of 500  $\mu$ h, or a capacitance of 100  $\mu$ mf, giving in either case a reactance of about 2000 ohms. The resonant frequency of a circuit containing these values of inductance and capacitance is, of course, 700 kc, approximately.

**USE OF FIGURE 2**

Figure 2 is used to obtain additional precision of reading but does not place the decimal point which must be located from a preliminary entry on Figure 1. Since the chart necessarily requires two logarithmic decades for inductance and capacitance for every single decade of frequency and reactance, unless the correct decade for L and C is chosen, the calculated values of reactance and frequency will be in error by a factor of 3.16.

**Example:** (Continued.) The reactance corresponding to 500  $\mu$ h or 100  $\mu$ mf is 2230 ohms at 712 kc, their resonant frequency.



**DECIBEL CONVERSION TABLES**

It is convenient in measurements and calculations on communications systems to express the ratio between any two amounts of electric or acoustic power in units on a logarithmic scale. The *decibel* (1/10th of the *bel*) on the briggsian or base-10 scale and the *neper* on the napierian or base-*e* scale are in almost universal use for this purpose.

Since voltage and current are related to power by impedance, both the *decibel* and the *neper* can be used to express voltage and current ratios, if care is taken to account for the

impedances associated with them. In a similar manner the corresponding acoustical quantities can be compared.

Table I and Table II on the following pages have been prepared to facilitate making conversions in either direction between the number of *decibels* and the corresponding power, voltage, and current ratios. Both tables can also be used for *nepers* and the *mile of standard cable* by applying the conversion factors from the table on the opposite page.

*Decibel* — The number of decibels  $N_{db}$  corresponding to the ratio between two amounts of power  $P_1$  and  $P_2$  is

$$N_{db} = 10 \log_{10} \frac{P_1}{P_2} \quad (1)$$

When two voltages  $E_1$  and  $E_2$  or two currents  $I_1$  and  $I_2$  operate in identical impedances,

$$N_{db} = 20 \log_{10} \frac{E_1}{E_2} \quad (2)$$

and 
$$N_{db} = 20 \log_{10} \frac{I_1}{I_2} \quad (3)$$

If  $E_1$  and  $E_2$  or  $I_1$  and  $I_2$  operate in unequal impedances,

$$N_{db} = 20 \log_{10} \frac{E_1}{E_2} + 10 \log_{10} \frac{Z_2}{Z_1} + 10 \log_{10} \frac{k_1}{k_2} \quad (4)$$

and 
$$N_{db} = 20 \log_{10} \frac{I_1}{I_2} + 10 \log_{10} \frac{Z_1}{Z_2} + 10 \log_{10} \frac{k_1}{k_2} \quad (5)$$

where  $Z_1$  and  $Z_2$  are the absolute magnitudes of the corresponding impedances and  $k_1$  and  $k_2$  are the values of power factor for the impedances.  $E_1$ ,  $E_2$ ,  $I_1$ , and  $I_2$  are also the absolute magnitudes of the corresponding quantities. Note that Table I and Table II can be

used to evaluate the impedance and power factor terms, since both are similar to the expression for power ratio, equation (1).

*Neper* — The number of nepers  $N_{nep}$  corresponding to a power ratio  $\frac{P_1}{P_2}$  is

$$N_{nep} = \frac{1}{2} \log_e \frac{P_1}{P_2} \quad (6)$$

For voltage ratios  $\frac{E_1}{E_2}$  or current ratios  $\frac{I_1}{I_2}$  working in identical impedances,

$$N_{nep} = \log_e \frac{E_1}{E_2} \quad (7)$$

and 
$$N_{nep} = \log_e \frac{I_1}{I_2}$$

When  $E_1$  and  $E_2$  or  $I_1$  and  $I_2$  operate in unequal impedances,

$$N_{nep} = \log_e \frac{E_1}{E_2} + \frac{1}{2} \log_e \frac{Z_2}{Z_1} + \frac{1}{2} \log_e \frac{k_1}{k_2} \quad (8)$$

and

$$N_{nep} = \log_e \frac{I_1}{I_2} + \frac{1}{2} \log_e \frac{Z_1}{Z_2} + \frac{1}{2} \log_e \frac{k_1}{k_2} \quad (9)$$

where  $Z_1$  and  $Z_2$  and  $k_1$  and  $k_2$  are as in equations (4) and (5).



## RELATIONS BETWEEN DECIBELS, NEPERS, AND MILES OF STANDARD CABLE

<i>Multiply</i>	<i>By</i>	<i>To Find</i>
decibels . . . . .	.1151	nepers
decibels . . . . .	1.056	miles of standard cable
miles of standard cable	.947	decibels
miles of standard cable	.109	nepers
nepers . . . . .	8.686	decibels
nepers . . . . .	9.175	miles of standard cable

## TO FIND VALUES OUTSIDE THE RANGE OF CONVERSION TABLES

Values outside the range of either Table I or Table II on the following pages can be readily found with the help of the following simple rules:

TABLE I: DECIBELS TO VOLTAGE AND POWER RATIOS

**Number of decibels positive (+):** Subtract +20 decibels successively from the given number of decibels until the remainder falls within range of Table I. *To find the voltage ratio*, multiply the corresponding value from the right-hand voltage-ratio column by 10 for each time you subtracted 20 db. *To find the power ratio*, multiply the corresponding value from the right-hand power-ratio column by 100 for each time you subtracted 20 db.

**Example—Given:** 49.2 db.

$$49.2 \text{ db} - 20 \text{ db} - 20 \text{ db} = 9.2 \text{ db}$$

$$\text{Voltage ratio: } 9.2 \text{ db} \rightarrow 2.884$$

$$2.884 \times 10 \times 10 = 288.4 \rightarrow 49.2 \text{ db}$$

$$\text{Power ratio: } 9.2 \text{ db} \rightarrow 8.318$$

$$8.318 \times 100 \times 100 = 83180 \rightarrow 49.2 \text{ db}$$

**Number of decibels negative (-):** Add +20 decibels successively to the given number of decibels until the sum falls within the range of Table I. *For the voltage ratio*, divide the value from the left-hand voltage-ratio column by 10 for each time you added 20 db. *For the power ratio*, divide the value from the left-hand power-ratio column by 100 for each time you added 20 db.

**Example—Given:** -49.2 db

$$-49.2 \text{ db} + 20 \text{ db} + 20 \text{ db} = -9.2 \text{ db}$$

$$\text{Voltage ratio: } -9.2 \text{ db} \rightarrow .3467$$

$$.3467 \times 1/10 \times 1/10 = .003467 \rightarrow -49.2 \text{ db}$$

$$\text{Power ratio: } -9.2 \text{ db} \rightarrow .1202$$

$$.1202 \times 1/100 \times 1/100 = .00001202 \rightarrow -49.2 \text{ db}$$

TABLE II: VOLTAGE RATIOS TO DECIBELS

**For ratios smaller than those in table—**Multiply the given ratio by 10 successively until the product can be found in the table. From the number of decibels thus found, subtract +20 decibels for each time you multiplied by 10.

**Example—Given:** Voltage ratio = .0131

$$.0131 \times 10 \times 10 = 1.31$$

$$\text{From Table II, } 1.31 \rightarrow 2.345 \text{ db}$$

$$2.345 \text{ db} - 20 \text{ db} - 20 \text{ db} = -37.655 \text{ db}$$

**For ratios greater than those in table—**Divide the given ratio by 10 successively until the remainder can be found in the table. To the number of decibels thus found, add +20 db for each time you divided by 10.

**Example—Given:** Voltage ratio = 712

$$712 \times 1/10 \times 1/10 = 7.12$$

$$\text{From Table II, } 7.12 \rightarrow 17.050 \text{ db}$$

$$17.050 \text{ db} + 20 \text{ db} + 20 \text{ db} = 57.050 \text{ db}$$



TABLE I

GIVEN: Decibels

TO FIND: Power and  $\left\{ \begin{matrix} \text{Voltage} \\ \text{Current} \end{matrix} \right\}$  Ratios

TO ACCOUNT FOR THE SIGN OF THE DECIBEL

For positive (+) values of the decibel — Both voltage and power ratios are greater than unity. Use the two right-hand columns.

For negative (-) values of the decibel — Both voltage and power ratios are less than unity. Use the two left-hand columns.

Example — Given:  $\pm 9.1$  db Find:

	Power Ratio	Voltage Ratio
+9.1 db	8.128	2.851
-9.1 db	0.1230	0.3508

← -db+ →					← -db+ →				
Voltage Ratio	Power Ratio	db	Voltage Ratio	Power Ratio	Voltage Ratio	Power Ratio	db	Voltage Ratio	Power Ratio
<b>1.0000</b>	<b>1.0000</b>	<b>0</b>	<b>1.000</b>	<b>1.000</b>	<b>.5623</b>	<b>.3162</b>	<b>5.0</b>	<b>1.778</b>	<b>3.162</b>
.9886	.9772	.1	1.012	1.023	.5559	.3090	5.1	1.799	3.236
.9772	.9550	.2	1.023	1.047	.5495	.3020	5.2	1.820	3.311
.9661	.9333	.3	1.035	1.072	.5433	.2951	5.3	1.841	3.388
.9550	.9120	.4	1.047	1.096	.5370	.2884	5.4	1.862	3.467
.9441	.8913	.5	1.059	1.122	.5309	.2818	5.5	1.884	3.548
.9333	.8710	.6	1.072	1.148	.5248	.2754	5.6	1.905	3.631
.9226	.8511	.7	1.084	1.175	.5188	.2692	5.7	1.928	3.715
.9120	.8318	.8	1.096	1.202	.5129	.2630	5.8	1.950	3.802
.9016	.8128	.9	1.109	1.230	.5070	.2570	5.9	1.972	3.890
<b>.8913</b>	<b>.7943</b>	<b>1.0</b>	<b>1.122</b>	<b>1.259</b>	<b>.5012</b>	<b>.2512</b>	<b>6.0</b>	<b>1.995</b>	<b>3.981</b>
.8810	.7762	1.1	1.135	1.288	.4955	.2455	6.1	2.018	4.074
.8710	.7586	1.2	1.148	1.318	.4898	.2399	6.2	2.042	4.169
.8610	.7413	1.3	1.161	1.349	.4842	.2344	6.3	2.065	4.266
.8511	.7244	1.4	1.175	1.380	.4786	.2291	6.4	2.089	4.365
.8414	.7079	1.5	1.189	1.413	.4732	.2239	6.5	2.113	4.467
.8318	.6918	1.6	1.202	1.445	.4677	.2188	6.6	2.138	4.571
.8222	.6761	1.7	1.216	1.479	.4624	.2138	6.7	2.163	4.677
.8128	.6607	1.8	1.230	1.514	.4571	.2089	6.8	2.188	4.786
.8035	.6457	1.9	1.245	1.549	.4519	.2042	6.9	2.213	4.898
<b>.7943</b>	<b>.6310</b>	<b>2.0</b>	<b>1.259</b>	<b>1.585</b>	<b>.4467</b>	<b>.1995</b>	<b>7.0</b>	<b>2.239</b>	<b>5.012</b>
.7852	.6166	2.1	1.274	1.622	.4416	.1950	7.1	2.265	5.129
.7762	.6026	2.2	1.288	1.660	.4365	.1905	7.2	2.291	5.248
.7674	.5888	2.3	1.303	1.698	.4315	.1862	7.3	2.317	5.370
.7586	.5754	2.4	1.318	1.738	.4266	.1820	7.4	2.344	5.495
.7499	.5623	2.5	1.334	1.778	.4217	.1778	7.5	2.371	5.623
.7413	.5495	2.6	1.349	1.820	.4169	.1738	7.6	2.399	5.754
.7328	.5370	2.7	1.365	1.862	.4121	.1698	7.7	2.427	5.888
.7244	.5248	2.8	1.380	1.905	.4074	.1660	7.8	2.455	6.026
.7161	.5129	2.9	1.396	1.950	.4027	.1622	7.9	2.483	6.166
<b>.7079</b>	<b>.5012</b>	<b>3.0</b>	<b>1.413</b>	<b>1.995</b>	<b>.3981</b>	<b>.1585</b>	<b>8.0</b>	<b>2.512</b>	<b>6.310</b>
.6998	.4898	3.1	1.429	2.042	.3936	.1549	8.1	2.541	6.457
.6918	.4786	3.2	1.445	2.089	.3890	.1514	8.2	2.570	6.607
.6839	.4677	3.3	1.462	2.138	.3846	.1479	8.3	2.600	6.761
.6761	.4571	3.4	1.479	2.188	.3802	.1445	8.4	2.630	6.918
.6683	.4467	3.5	1.496	2.239	.3758	.1413	8.5	2.661	7.079
.6607	.4365	3.6	1.514	2.291	.3715	.1380	8.6	2.692	7.244
.6531	.4266	3.7	1.531	2.344	.3673	.1349	8.7	2.723	7.413
.6457	.4169	3.8	1.549	2.399	.3631	.1318	8.8	2.754	7.586
.6383	.4074	3.9	1.567	2.455	.3589	.1288	8.9	2.786	7.762
<b>.6310</b>	<b>.3981</b>	<b>4.0</b>	<b>1.585</b>	<b>2.512</b>	<b>.3548</b>	<b>.1259</b>	<b>9.0</b>	<b>2.818</b>	<b>7.943</b>
.6237	.3890	4.1	1.603	2.570	.3508	.1230	9.1	2.851	8.128
.6166	.3802	4.2	1.622	2.630	.3467	.1202	9.2	2.884	8.318
.6095	.3715	4.3	1.641	2.692	.3428	.1175	9.3	2.917	8.511
.6026	.3631	4.4	1.660	2.754	.3388	.1148	9.4	2.951	8.710
.5957	.3548	4.5	1.679	2.818	.3350	.1122	9.5	2.985	8.913
.5888	.3467	4.6	1.698	2.884	.3311	.1096	9.6	3.020	9.120
.5821	.3388	4.7	1.718	2.951	.3273	.1072	9.7	3.055	9.333
.5754	.3311	4.8	1.738	3.020	.3236	.1047	9.8	3.090	9.550
.5689	.3236	4.9	1.758	3.090	.3199	.1023	9.9	3.126	9.772



TABLE I (continued)

← -db+ →					← -db+ →				
Voltage Ratio	Power Ratio	db	Voltage Ratio	Power Ratio	Voltage Ratio	Power Ratio	db	Voltage Ratio	Power Ratio
.3162	<b>1.000</b>	<b>10.0</b>	<b>3.162</b>	<b>10.000</b>	<b>.1585</b>	<b>.02512</b>	<b>16.0</b>	<b>6.310</b>	<b>39.81</b>
.3126	.09772	10.1	3.199	10.23	.1567	.02455	16.1	6.383	40.74
.3090	.09550	10.2	3.236	10.47	.1549	.02399	16.2	6.457	41.69
.3055	.09333	10.3	3.273	10.72	.1531	.02344	16.3	6.531	42.66
.3020	.09120	10.4	3.311	10.96	.1514	.02291	16.4	6.607	43.65
.2985	.08913	10.5	3.350	11.22	.1496	.02239	16.5	6.683	44.67
.2951	.08710	10.6	3.388	11.48	.1479	.02188	16.6	6.761	45.71
.2917	.08511	10.7	3.428	11.75	.1462	.02138	16.7	6.839	46.77
.2884	.08318	10.8	3.467	12.02	.1445	.02089	16.8	6.918	47.86
.2851	.08128	10.9	3.508	12.30	.1429	.02042	16.9	6.998	48.98
<b>.2818</b>	<b>.07943</b>	<b>11.0</b>	<b>3.548</b>	<b>12.59</b>	<b>.1413</b>	<b>.01995</b>	<b>17.0</b>	<b>7.079</b>	<b>50.12</b>
.2786	.07762	11.1	3.589	12.88	.1396	.01950	17.1	7.161	51.29
.2754	.07586	11.2	3.631	13.18	.1380	.01905	17.2	7.244	52.48
.2723	.07413	11.3	3.673	13.49	.1365	.01862	17.3	7.328	53.70
.2692	.07244	11.4	3.715	13.80	.1349	.01820	17.4	7.413	54.95
.2661	.07079	11.5	3.758	14.13	.1334	.01778	17.5	7.499	56.23
.2630	.06918	11.6	3.802	14.45	.1318	.01738	17.6	7.586	57.54
.2600	.06761	11.7	3.846	14.79	.1303	.01698	17.7	7.674	58.88
.2570	.06607	11.8	3.890	15.14	.1288	.01660	17.8	7.762	60.26
.2541	.06457	11.9	3.936	15.49	.1274	.01622	17.9	7.852	61.66
<b>.2512</b>	<b>.06310</b>	<b>12.0</b>	<b>3.981</b>	<b>15.85</b>	<b>.1259</b>	<b>.01585</b>	<b>18.0</b>	<b>7.943</b>	<b>63.10</b>
.2483	.06166	12.1	4.027	16.22	.1245	.01549	18.1	8.035	64.57
.2455	.06026	12.2	4.074	16.60	.1230	.01514	18.2	8.128	66.07
.2427	.05888	12.3	4.121	16.98	.1216	.01479	18.3	8.222	67.61
.2399	.05754	12.4	4.169	17.38	.1202	.01445	18.4	8.318	69.18
.2371	.05623	12.5	4.217	17.78	.1189	.01413	18.5	8.414	70.79
.2344	.05495	12.6	4.266	18.20	.1175	.01380	18.6	8.511	72.44
.2317	.05370	12.7	4.315	18.62	.1161	.01349	18.7	8.610	74.13
.2291	.05248	12.8	4.365	19.05	.1148	.01318	18.8	8.710	75.86
.2265	.05129	12.9	4.416	19.50	.1135	.01288	18.9	8.811	77.62
<b>.2239</b>	<b>.05012</b>	<b>13.0</b>	<b>4.467</b>	<b>19.95</b>	<b>.1122</b>	<b>.01259</b>	<b>19.0</b>	<b>8.913</b>	<b>79.43</b>
.2213	.04898	13.1	4.519	20.42	.1109	.01230	19.1	9.016	81.28
.2188	.04786	13.2	4.571	20.89	.1096	.01202	19.2	9.120	83.18
.2163	.04677	13.3	4.624	21.38	.1084	.01175	19.3	9.226	85.11
.2138	.04571	13.4	4.677	21.88	.1072	.01148	19.4	9.333	87.10
.2113	.04467	13.5	4.732	22.39	.1059	.01122	19.5	9.441	89.13
.2089	.04365	13.6	4.786	22.91	.1047	.01096	19.6	9.550	91.20
.2065	.04266	13.7	4.842	23.44	.1035	.01072	19.7	9.661	93.33
.2042	.04169	13.8	4.898	23.99	.1023	.01047	19.8	9.772	95.50
.2018	.04074	13.9	4.955	24.55	.1012	.01023	19.9	9.886	97.72
<b>.1995</b>	<b>.03981</b>	<b>14.0</b>	<b>5.012</b>	<b>25.12</b>	<b>.1000</b>	<b>.01000</b>	<b>20.0</b>	<b>10.000</b>	<b>100.00</b>
.1972	.03890	14.1	5.070	25.70					
.1950	.03802	14.2	5.129	26.30					
.1928	.03715	14.3	5.188	26.92					
.1905	.03631	14.4	5.248	27.54					
.1884	.03548	14.5	5.309	28.18					
.1862	.03467	14.6	5.370	28.84					
.1841	.03388	14.7	5.433	29.51					
.1820	.03311	14.8	5.495	30.20					
.1799	.03236	14.9	5.559	30.90					
<b>.1778</b>	<b>.03162</b>	<b>15.0</b>	<b>5.623</b>	<b>31.62</b>					
.1758	.03090	15.1	5.689	32.36					
.1738	.03020	15.2	5.754	33.11					
.1718	.02951	15.3	5.821	33.88					
.1698	.02884	15.4	5.888	34.67					
.1679	.02818	15.5	5.957	35.48					
.1660	.02754	15.6	6.026	36.31					
.1641	.02692	15.7	6.095	37.15					
.1622	.02630	15.8	6.166	38.02					
.1603	.02570	15.9	6.237	38.90					

← -db+ →				
Voltage Ratio	Power Ratio	db	Voltage Ratio	Power Ratio
<b>3.162 × 10<sup>-1</sup></b>	<b>10<sup>-1</sup></b>	<b>10</b>	<b>3.162</b>	<b>10</b>
	10 <sup>-1</sup>	20	10	10 <sup>2</sup>
3.162 × 10 <sup>-2</sup>	10 <sup>-3</sup>	30	3.162 × 10	10 <sup>3</sup>
	10 <sup>-4</sup>	40	10 <sup>2</sup>	10 <sup>4</sup>
3.162 × 10 <sup>-3</sup>	10 <sup>-5</sup>	50	3.162 × 10 <sup>2</sup>	10 <sup>5</sup>
	10 <sup>-6</sup>	60	10 <sup>3</sup>	10 <sup>6</sup>
3.162 × 10 <sup>-4</sup>	10 <sup>-7</sup>	70	3.162 × 10 <sup>3</sup>	10 <sup>7</sup>
	10 <sup>-8</sup>	80	10 <sup>4</sup>	10 <sup>8</sup>
3.162 × 10 <sup>-5</sup>	10 <sup>-9</sup>	90	3.162 × 10 <sup>4</sup>	10 <sup>9</sup>
<b>10<sup>-5</sup></b>	<b>10<sup>-10</sup></b>	<b>100</b>	<b>10<sup>5</sup></b>	<b>10<sup>10</sup></b>

To find decibel values outside the range of this table, see page 247



TABLE II

GIVEN: { Voltage  
Current } Ratio

TO FIND: Decibels

POWER RATIOS

To find the number of decibels corresponding to a given power ratio — Assume the given power ratio to be a voltage ratio and find the corresponding number of decibels from the table. The desired result is exactly one-half of the number of decibels thus found.

Example — Given: a power ratio of 3.41.

Find: 3.41 in the table:

3.41 → 10.655 db (voltage)

10.655 db × 1/2 = 5.328 db (power)

Voltage Ratio	.00	.01	.02	.03	.04	.05	.06	.07	.08	.09
1.0	.000	.086	.172	.257	.341	.424	.506	.588	.668	.749
1.1	.828	.906	.984	1.062	1.138	1.214	1.289	1.364	1.438	1.511
1.2	1.584	1.656	1.727	1.798	1.868	1.938	2.007	2.076	2.144	2.212
1.3	2.279	2.345	2.411	2.477	2.542	2.607	2.671	2.734	2.798	2.860
1.4	2.923	2.984	3.046	3.107	3.167	3.227	3.287	3.346	3.405	3.464
1.5	3.522	3.580	3.637	3.694	3.750	3.807	3.862	3.918	3.973	4.028
1.6	4.082	4.137	4.190	4.244	4.297	4.350	4.402	4.454	4.506	4.558
1.7	4.609	4.660	4.711	4.761	4.811	4.861	4.910	4.959	5.008	5.057
1.8	5.105	5.154	5.201	5.249	5.296	5.343	5.390	5.437	5.483	5.529
1.9	5.575	5.621	5.666	5.711	5.756	5.801	5.845	5.889	5.933	5.977
2.0	6.021	6.064	6.107	6.150	6.193	6.235	6.277	6.319	6.361	6.403
2.1	6.444	6.486	6.527	6.568	6.608	6.649	6.689	6.729	6.769	6.809
2.2	6.848	6.888	6.927	6.966	7.008	7.044	7.082	7.121	7.159	7.197
2.3	7.235	7.272	7.310	7.347	7.384	7.421	7.458	7.495	7.532	7.568
2.4	7.604	7.640	7.676	7.712	7.748	7.783	7.819	7.854	7.889	7.924
2.5	7.959	7.993	8.028	8.062	8.097	8.131	8.165	8.199	8.232	8.266
2.6	8.299	8.333	8.366	8.399	8.432	8.465	8.498	8.530	8.563	8.595
2.7	8.627	8.659	8.691	8.723	8.755	8.787	8.818	8.850	8.881	8.912
2.8	8.943	8.974	9.005	9.036	9.066	9.097	9.127	9.158	9.188	9.218
2.9	9.248	9.278	9.308	9.337	9.367	9.396	9.426	9.455	9.484	9.513
3.0	9.542	9.571	9.600	9.629	9.657	9.686	9.714	9.743	9.771	9.799
3.1	9.827	9.855	9.883	9.911	9.939	9.966	9.994	10.021	10.049	10.076
3.2	10.103	10.130	10.157	10.184	10.211	10.238	10.264	10.291	10.317	10.344
3.3	10.370	10.397	10.423	10.449	10.475	10.501	10.527	10.553	10.578	10.604
3.4	10.630	10.655	10.681	10.706	10.731	10.756	10.782	10.807	10.832	10.857
3.5	10.881	10.906	10.931	10.955	10.980	11.005	11.029	11.053	11.078	11.102
3.6	11.126	11.150	11.174	11.198	11.222	11.246	11.270	11.293	11.317	11.341
3.7	11.364	11.387	11.411	11.434	11.457	11.481	11.504	11.527	11.550	11.573
3.8	11.596	11.618	11.641	11.664	11.687	11.709	11.732	11.754	11.777	11.799
3.9	11.821	11.844	11.866	11.888	11.910	11.932	11.954	11.976	11.998	12.019
4.0	12.041	12.063	12.085	12.106	12.128	12.149	12.171	12.192	12.213	12.234
4.1	12.256	12.277	12.298	12.319	12.340	12.361	12.382	12.403	12.424	12.444
4.2	12.465	12.486	12.506	12.527	12.547	12.568	12.588	12.609	12.629	12.649
4.3	12.669	12.690	12.710	12.730	12.750	12.770	12.790	12.810	12.829	12.849
4.4	12.869	12.889	12.908	12.928	12.948	12.967	12.987	13.006	13.026	13.045
4.5	13.064	13.084	13.103	13.122	13.141	13.160	13.179	13.198	13.217	13.236
4.6	13.255	13.274	13.293	13.312	13.330	13.349	13.368	13.386	13.405	13.423
4.7	13.442	13.460	13.479	13.497	13.516	13.534	13.552	13.570	13.589	13.607
4.8	13.625	13.643	13.661	13.679	13.697	13.715	13.733	13.751	13.768	13.786
4.9	13.804	13.822	13.839	13.857	13.875	13.892	13.910	13.927	13.945	13.962
5.0	13.979	13.997	14.014	14.031	14.049	14.066	14.083	14.100	14.117	14.134
5.1	14.151	14.168	14.185	14.202	14.219	14.236	14.253	14.270	14.287	14.303
5.2	14.320	14.337	14.353	14.370	14.387	14.403	14.420	14.436	14.453	14.469
5.3	14.486	14.502	14.518	14.535	14.551	14.567	14.583	14.599	14.616	14.632
5.4	14.648	14.664	14.680	14.696	14.712	14.728	14.744	14.760	14.776	14.791
5.5	14.807	14.823	14.839	14.855	14.870	14.886	14.902	14.917	14.933	14.948
5.6	14.964	14.979	14.995	15.010	15.026	15.041	15.056	15.072	15.087	15.102
5.7	15.117	15.133	15.148	15.163	15.178	15.193	15.208	15.224	15.239	15.254
5.8	15.269	15.284	15.298	15.313	15.328	15.343	15.358	15.373	15.388	15.402
5.9	15.417	15.432	15.446	15.461	15.476	15.490	15.505	15.519	15.534	15.549



TABLE II (continued)

<i>Voltage Ratio</i>	.00	.01	.02	.03	.04	.05	.06	.07	.08	.09
<b>6.0</b>	<b>15.563</b>	<b>15.577</b>	<b>15.592</b>	<b>15.606</b>	<b>15.621</b>	<b>15.635</b>	<b>15.649</b>	<b>15.664</b>	<b>15.678</b>	<b>15.692</b>
6.1	15.707	15.721	15.735	15.749	15.763	15.778	15.792	15.806	15.820	15.834
6.2	15.848	15.862	15.876	15.890	15.904	15.918	15.931	15.945	15.959	15.973
6.3	15.987	16.001	16.014	16.028	16.042	16.055	16.069	16.083	16.096	16.110
6.4	16.124	16.137	16.151	16.164	16.178	16.191	16.205	16.218	16.232	16.245
6.5	16.258	16.272	16.285	16.298	16.312	16.325	16.338	16.351	16.365	16.378
6.6	16.391	16.404	16.417	16.430	16.443	16.456	16.469	16.483	16.496	16.509
6.7	16.521	16.534	16.547	16.560	16.573	16.586	16.599	16.612	16.625	16.637
6.8	16.650	16.663	16.676	16.688	16.701	16.714	16.726	16.739	16.752	16.764
6.9	16.777	16.790	16.802	16.815	16.827	16.840	16.852	16.865	16.877	16.890
<b>7.0</b>	<b>16.902</b>	<b>16.914</b>	<b>16.927</b>	<b>16.939</b>	<b>16.951</b>	<b>16.964</b>	<b>16.976</b>	<b>16.988</b>	<b>17.001</b>	<b>17.013</b>
7.1	17.025	17.037	17.050	17.062	17.074	17.086	17.098	17.110	17.122	17.135
7.2	17.147	17.159	17.171	17.183	17.195	17.207	17.219	17.231	17.243	17.255
7.3	17.266	17.278	17.290	17.302	17.314	17.326	17.338	17.349	17.361	17.373
7.4	17.385	17.396	17.408	17.420	17.431	17.443	17.455	17.466	17.478	17.490
7.5	17.501	17.513	17.524	17.536	17.547	17.559	17.570	17.582	17.593	17.605
7.6	17.616	17.628	17.639	17.650	17.662	17.673	17.685	17.696	17.707	17.719
7.7	17.730	17.741	17.752	17.764	17.775	17.786	17.797	17.808	17.820	17.831
7.8	17.842	17.853	17.864	17.875	17.886	17.897	17.908	17.919	17.931	17.942
7.9	17.953	17.964	17.975	17.985	17.996	18.007	18.018	18.029	18.040	18.051
<b>8.0</b>	<b>18.062</b>	<b>18.073</b>	<b>18.083</b>	<b>18.094</b>	<b>18.105</b>	<b>18.116</b>	<b>18.127</b>	<b>18.137</b>	<b>18.148</b>	<b>18.159</b>
8.1	18.170	18.180	18.191	18.202	18.212	18.223	18.234	18.244	18.255	18.266
8.2	18.276	18.287	18.297	18.308	18.319	18.329	18.340	18.350	18.361	18.371
8.3	18.382	18.392	18.402	18.413	18.423	18.434	18.444	18.455	18.465	18.475
8.4	18.486	18.496	18.506	18.517	18.527	18.537	18.547	18.558	18.568	18.578
8.5	18.588	18.599	18.609	18.619	18.629	18.639	18.649	18.660	18.670	18.680
8.6	18.690	18.700	18.710	18.720	18.730	18.740	18.750	18.760	18.770	18.780
8.7	18.790	18.800	18.810	18.820	18.830	18.840	18.850	18.860	18.870	18.880
8.8	18.890	18.900	18.909	18.919	18.929	18.939	18.949	18.958	18.968	18.978
8.9	18.988	18.998	19.007	19.017	19.027	19.036	19.046	19.056	19.066	19.075
<b>9.0</b>	<b>19.085</b>	<b>19.094</b>	<b>19.104</b>	<b>19.114</b>	<b>19.123</b>	<b>19.133</b>	<b>19.143</b>	<b>19.152</b>	<b>19.162</b>	<b>19.171</b>
9.1	19.181	19.190	19.200	19.209	19.219	19.228	19.238	19.247	19.257	19.266
9.2	19.276	19.285	19.295	19.304	19.313	19.323	19.332	19.342	19.351	19.360
9.3	19.370	19.379	19.388	19.398	19.407	19.416	19.426	19.435	19.444	19.453
9.4	19.463	19.472	19.481	19.490	19.499	19.509	19.518	19.527	19.536	19.545
9.5	19.554	19.564	19.573	19.582	19.591	19.600	19.609	19.618	19.627	19.636
9.6	19.645	19.654	19.664	19.673	19.682	19.691	19.700	19.709	19.718	19.726
9.7	19.735	19.744	19.753	19.762	19.771	19.780	19.789	19.798	19.807	19.816
9.8	19.825	19.833	19.842	19.851	19.860	19.869	19.878	19.886	19.895	19.904
9.9	19.913	19.921	19.930	19.939	19.948	19.956	19.965	19.974	19.983	19.991

<i>Voltage Ratio</i>	0	1	2	3	4	5	6	7	8	9
<b>10</b>	<b>20.000</b>	<b>20.828</b>	<b>21.584</b>	<b>22.279</b>	<b>22.923</b>	<b>23.522</b>	<b>24.082</b>	<b>24.609</b>	<b>25.105</b>	<b>25.575</b>
20	26.021	26.444	26.848	27.235	27.604	27.959	28.299	28.627	28.943	29.248
30	29.542	29.827	30.103	30.370	30.630	30.881	31.126	31.364	31.596	31.821
40	32.041	32.256	32.465	32.669	32.869	33.064	33.255	33.442	33.625	33.804
50	33.979	34.151	34.320	34.486	34.648	34.807	34.964	35.117	35.269	35.417
60	35.563	35.707	35.848	35.987	36.124	36.258	36.391	36.521	36.650	36.777
70	36.902	37.025	37.147	37.266	37.385	37.501	37.616	37.730	37.842	37.953
80	38.062	38.170	38.276	38.382	38.486	38.588	38.690	38.790	38.890	38.988
90	39.085	39.181	39.276	39.370	39.463	39.554	39.645	39.735	39.825	39.913
<b>100</b>	<b>40.000</b>	—	—	—	—	—	—	—	—	—

To find ratios outside the range of this table, see page 247

## INDEX BY TYPE NUMBER

<i>Type</i>	<i>Name</i>	<i>Page</i>	<i>Type</i>	<i>Name</i>	<i>Page</i>
CAP-35	Power Cord . . . . .	242	720-A	Heterodyne Frequency Meter . . . . .	85
DNT	Detectors . . . . .	69	722	Precision Capacitor . . . . .	151
KN	Knobs . . . . .	238	723	Vacuum-Tube Fork . . . . .	109
M-2	Variac® Autotransformer	215	736-A	Wave Analyzer . . . . .	224
M-5	Variac® Autotransformer	215	740-B	Capacitance Test Bridge . . . . .	25
M-10	Variac® Autotransformer	215	759-P21	Tripod and Extension Cable . . . . .	182
V-2	Superseded by Type W-2 . . . . .	210	759-P22	100-foot Cable . . . . .	181
V-5	Superseded by Type W-5 . . . . .	211	759-P25	Dynamic Microphone Assembly . . . . .	181
V-10	Variac® Autotransformer	212	759-P35	Vibration Pickup . . . . .	182
V-20	Variac® Autotransformer	213	759-P36	Control Box . . . . .	182
W-2	Variac® Autotransformer	210	760-B	Sound Analyzer . . . . .	186
W-5	Variac® Autotransformer	211	761-A	Vibration Meter . . . . .	188, 189
50	Variac® Autotransformer	214	762-B	Vibration Analyzer . . . . .	190
50-P1, P2	Chokes . . . . .	208, 214	783-A	Output Power Meter . . . . .	134
60-AM, AU	Superseded by Type M . . . . .	215	805-C	Standard Signal Generator	96
71-A	Variac Transformer . . . . .	216	821-A	Twin-T . . . . .	42
107	Variable Inductor . . . . .	164	830-R	Wave Filter . . . . .	225
200-B	Superseded by Type W-2 . . . . .	210	838-B	Alligator Clip . . . . .	241
214-A	Superseded by 970-Series . . . . .	231	874	Coaxial Elements . . . . .	45
219	Decade Condenser . . . . .	160	874-LBA	Slotted Line and Vernier . . . . .	46
274	Plugs and Jacks . . . . .	239	874-MD	Slotted-Line Motor Drive	48
274	Patch Cords . . . . .	242	901-S	Dials . . . . .	236
301-A	Superseded by 970-Series . . . . .	231	907-R	X-Y Dial Drives . . . . .	203
314-A	Superseded by 970-Series . . . . .	231	908-P1, P2	Synchronous Dial Drives	202
371-A, T	Superseded by 970-Series . . . . .	231	908-R	X-Y Dial Drives . . . . .	203
380	Superseded by 980-Series . . . . .	158	916-A	Superseded by Type 1606-A	36
471-A	Superseded by 970-Series . . . . .	231	916-AL	Radio-Frequency Bridge . . . . .	38
480-P	Panels . . . . .	117	938	Binding Posts and Jacks . . . . .	240
500	Resistor . . . . .	175	940	Decade Inductor . . . . .	165
505	Capacitor . . . . .	155	941-A	Toroidal Transformer	234
509	Capacitor . . . . .	156	942-A	Output Transformer . . . . .	234
510	Decade Resistance Unit . . . . .	170	970	Potentiometer . . . . .	231
544-B	Megohm Bridge . . . . .	18	970-P	Potentiometer Dial Plates	236
546-C	A-F Microvolter . . . . .	135	980	Decade Capacitor Unit . . . . .	158
561-D	Vacuum-Tube Bridge . . . . .	43	1000-P3	Voltage Divider . . . . .	98
578	Shielded Transformer . . . . .	235	1000-P4	Dummy Antenna . . . . .	98
583-A	Output Power Meter . . . . .	133	1000-P5	Transformer . . . . .	98
631-BL	Strobotac . . . . .	192	1000-P6	Crystal Diode Modulator	99
631-P1	Strobotron . . . . .	192	1000-P7	Balanced Modulator . . . . .	100
648-A	Strobolux . . . . .	193	1000-P10	Test Loop . . . . .	98
648-P1	Replacement Lamp . . . . .	193	1001-A	Standard-Signal Generator	94
650-A	Impedance Bridge . . . . .	28	1021	Standard-Signal Generators . . . . .	92
650-P1	Oscillator-Amplifier . . . . .	29	1100-AP, AQ	Frequency Standard . . . . .	74
651-AE, AH	Oscillograph Recorders . . . . .	228	1105-A	Frequency Measurement Equipment . . . . .	77
667-A	Inductance Bridge . . . . .	30	1106-A, B, C	Frequency Transfer Units	80
670-F	Compensated Decade Resistor . . . . .	172	1107-A	Interpolation Oscillator . . . . .	82
674	Jumbo Plugs and Jacks . . . . .	239	1108-A	Coupling Panel . . . . .	83
715-A	Superseded by Type 1230-A	2			
716-C	Capacitance Bridge . . . . .	18			
716-CS1	Capacitance Bridge . . . . .	20			
716-P4	Guard Circuit . . . . .	22			



## INDEX BY TYPE NUMBER

<i>Type</i>	<i>Name</i>	<i>Page</i>	<i>Type</i>	<i>Name</i>	<i>Page</i>
1109-A	Comparison Oscilloscope .	84	1391-A	Pulse, Sweep, and Time-Delay Generator . . . .	120
1110-A	Interpolation Frequency Standard . . . . .	86	1401	Fixed Air Capacitor . . . .	154
1170-B	F-M Monitor . . . . .	138	1419-A	Polystyrene Decade Capacitor . . . . .	157
1176-A	Frequency Meter . . . . .	89	1420	Variable Air Capacitor . .	230
1181-A	Frequency Deviation Monitor . . . . .	138	1432	Decade Resistor . . . . .	169
1181-AT	Color Subcarrier Monitor	139	1450	Decade Attenuator . . . .	173
1184-A	TV-Transmitter Monitor.	140	1454-A	Decade Voltage Divider .	174
1201-A	Unit Regulated Power Supply . . . . .	145	1481	Standard Inductor . . . .	163
1202-A	Unit Vibrator Power Supply . . . . .	146	1482	Standard Inductor . . . .	162
1203-A	Unit Power Supply . . . .	144	1490	Decade Inductor . . . . .	165
1204-B	Unit Variable Power Supply . . . . .	145	1501-A	Light Meter . . . . .	136
1206-B	Unit Amplifier . . . . .	5	1530-A	Microflash . . . . .	196
1208-B	Unit Oscillator . . . . .	116	1532-B	Strobolume . . . . .	194
1209-B	Unit Oscillator . . . . .	116	1534-A	Polariscope . . . . .	197
1210-B	Unit R-C Oscillator . . . .	114	1535-B	Contactors . . . . .	195
1210-P1	Detector and Discriminator	115	1550-A	Octave-Band Noise Analyzer . . . . .	185
1211-B	Unit Oscillator . . . . .	113	1551-A	Sound-Level Meter . . . .	178
1212-A	Unit Null Detector . . . .	66	1551-P1	Condenser Microphone System . . . . .	180
1212-P1, P2	Filters . . . . .	67	1551-P11	Attenuator Pad . . . . .	181
1213-C	Unit Time/Frequency Calibrator . . . . .	88	1552-B	Sound-Level Calibrator . .	184
1214-A	Unit Oscillator . . . . .	112	1555-A	Sound-Survey Meter . . . .	183
1215-B	Unit Oscillator . . . . .	117	1556-A	Impact Noise Analyzer . .	187
1216-A	Unit IF Amplifier . . . . .	68	1570-A	Automatic Voltage Regulator . . . . .	218
1217-A	Unit Pulser . . . . .	122	1601-A	V-H-F Bridge . . . . .	39
1218-A	Unit Oscillator . . . . .	117	1602-B	U-H-F Admittance Meter .	40
1219-A	Unit Pulse Amplifier . . . .	123	1603-A	Z-Y Bridge . . . . .	34
1220-A	Unit Klystron Oscillator .	118	1604-B	Comparison Bridge . . . .	31
1230-A, AE	D-C Amplifier and Electrometer . . . . .	2	1605-A	Impedance Comparator . .	32
1231-B	Amplifier and Null Detector . . . . .	64	1606-A	R-F Bridge . . . . .	36
1231-P	Filters and Attenuator . . .	65	1610-A	Capacitance Measuring Assembly . . . . .	24
1233-A	Power Amplifier . . . . .	4	1611-A	Capacitance Test Bridge . .	26
1261-A	Power Supply . . . . .	147	1651-A	Bolometer Bridge . . . . .	50
1262-A	Power Supply . . . . .	147	1652-A	Resistance Limit Bridge . .	14
1263-A	Amplitude-Regulating Power Supply . . . . .	148	1690-A	Dielectric Sample Holder .	23
1301-A	Low-Distortion Oscillator	103	1691-A	Capacitance Test Jig . . . .	21
1301-P1	Range Extension Unit . . . .	103	1700-5	Variac® Speed Controls . .	220
1302-A	Oscillator . . . . .	108	1702-P3	Switch . . . . .	220
1303-A	Two-Signal Audio Generator . . . . .	106	1705-P1	Drum Controller . . . . .	220
1304-B	Beat-Frequency Audio Generator . . . . .	104	1750-A	Sweep Drive . . . . .	200
1307-A	Transistor Oscillator . . . .	109	1800-B	Vacuum-Tube Voltmeter . .	128
1330-A	Bridge Oscillator . . . . .	110	1800-P	Multipliers . . . . .	131
1390-A	Random Noise Generator	124	1803-B	Vacuum-Tube Voltmeter . .	130
1390-P1	Voltage Divider . . . . .	125	1862-B	Megohmmeter . . . . .	132
			1931-A	Modulation Monitor . . . .	142
			1932-A	Distortion and Noise Meter . . . . .	226
			1932-P1	A-M Detector Unit . . . . .	227
			1951-A	Filter . . . . .	67

# INDEX BY TITLE

	<i>Page</i>		<i>Page</i>
Adaptor Plug, Microphone . . . . .	185	Universal . . . . .	28, 34
Adaptors, Coaxial . . . . .	62	V-H-F . . . . .	39
Adjustable Autotransformer, Variac® . . . . .	206-217	Vacuum Tube . . . . .	43
Adjustable Lines and Stubs, Coaxial . . . . .	54, 56	Z-Y . . . . .	34
Adjustable Power Supply . . . . .	145	Bridge Amplifier . . . . .	64, 66
Admittance Meter, UHF . . . . .	40	Bridge Amplifier-Oscillator . . . . .	29
Admittance Bridge, A-F . . . . .	34	Bridge Detector . . . . .	29, 64, 66, 69
Air Capacitor, Fixed . . . . .	154	Bridge Guard Circuit . . . . .	22
Precision . . . . .	151-153	Bridge Transformer . . . . .	235
Standard . . . . .	151-154	Broad-Band Modulator . . . . .	99, 100
Variable . . . . .	56, 151-153, 230	Broadcast Monitors, Frequency and Modulation . . . . .	137-143
Air Line, Coaxial . . . . .	54	Cable, Coaxial . . . . .	60
Alligator Clip . . . . .	241	Cable, Extension and Tripod . . . . .	182
A-M Detector . . . . .	49, 227	Cable Connectors, Coaxial . . . . .	61
Amplifier, Audio-Frequency . . . . .	4, 5, 64, 65	Calibrator, Sound-Level . . . . .	184
Direct Current . . . . .	2	Calibrator, Time/Frequency . . . . .	88
Power . . . . .	4	Camera (Continuous-Film Recorder) . . . . .	228
Pulse . . . . .	123	Capacitance Bridge 18, 20, 24, 25, 26, 28, 36, 38, 39, 42	
Amplifier and Null Detector . . . . .	64, 66	Capacitors . . . . .	149-160
Amplitude Modulator . . . . .	99, 100	Capacitor, Air Dielectric . . . . .	56, 151-154, 230
Amplitude-Regulating Power Supply . . . . .	148	Decade . . . . .	157, 158, 160
Analyzer, Impact Noise . . . . .	187	Fixed . . . . .	154, 155, 156
Noise . . . . .	185, 186, 187	Mica Dielectric . . . . .	155, 156, 158-160
Octave-Band . . . . .	185	Paper Dielectric . . . . .	158-160
Sound . . . . .	185, 186	Polystyrene Dielectric . . . . .	157, 158
Vibration . . . . .	190	Precision . . . . .	151-153
Wave . . . . .	224	Standard . . . . .	151-153, 154, 156
Antenna, Dummy . . . . .	98	Variable Air . . . . .	56, 151-153, 230
Antenna Measuring Equipment . . . . .	36, 38, 39, 40	Capacitor Test Fixture . . . . .	21
Attenuator, Adjustable . . . . .	64	Case for Sound-Survey Meter . . . . .	183
Coaxial . . . . .	57	for Transistor Oscillator . . . . .	109
Decade . . . . .	173	Chokes (for Variacs) . . . . .	208, 214
Pad (for sound-level meter) . . . . .	181	Cliplock, Coaxial . . . . .	61
Audio-Frequency Meter . . . . .	89	Coaxial Elements . . . . .	54-62
Microvolter . . . . .	135	Coaxial Patchcords . . . . .	60
Oscillator . . . . .	82, 103-114	Color T-V, Subcarrier Frequency Monitor . . . . .	139
Audio Generator, Beat-Frequency . . . . .	104	Comparator, Impedance . . . . .	32
Two-Signal . . . . .	106	Comparison Bridges . . . . .	14, 31, 32
Automatic Voltage Regulator . . . . .	218	Comparison Oscilloscope . . . . .	84
Automatic Dial Drives . . . . .	199-202	Compensated Decade Resistor . . . . .	172
Autotransformer, Variac® . . . . .	206-217	Component Mounts . . . . .	3, 59
Balanced Modulator . . . . .	100	Condenser Microphone System . . . . .	180
Balun . . . . .	52	Connectors, Coaxial . . . . .	61
Band Analyzer, Octave- . . . . .	185	Shielded . . . . .	239
Band-Pass Filter . . . . .	225	Contact, Stroboscopic . . . . .	195
Bar Knobs . . . . .	238	Control Box and Vibration Pickup . . . . .	182
Basic Connector, Coaxial . . . . .	61	Controls, Motor Speed . . . . .	220-222
Basic Motor Speed Controls . . . . .	221, 222	Cords, Patch and Power . . . . .	242
Beat-Frequency Oscillators . . . . .	82, 104, 106	Coupling Elements, Coaxial . . . . .	56
Binding Posts . . . . .	240	Coupling Panel . . . . .	83
Bolometers . . . . .	50	Crystal Diode Modulator . . . . .	99, 100
Bolometer Bridge . . . . .	50	Decade Attenuator . . . . .	173
Bridges, Antenna Measuring . . . . .	36, 38, 39, 40	Decade Capacitor . . . . .	157-160
Bolometer . . . . .	50	Decade Inductor . . . . .	165
Capacitance 18, 20, 24, 25, 26, 28, 34, 36, 38, 39, 42		Decade Resistor . . . . .	169-172
D-C Limit . . . . .	14	Decade Switches . . . . .	159, 171
High-Resistance . . . . .	16	Decade Voltage Divider . . . . .	174
Impedance . . . . .	28, 31, 32, 34, 36, 38, 39, 40	Delay Generator, Time . . . . .	120
Impedance Comparison . . . . .	31, 32	Detector and Discriminator . . . . .	115
Inductance . . . . .	30	Detectors . . . . .	49, 63-69, 227
Megohm . . . . .	16	Detectors, Null . . . . .	63-69, 156, 223
Power Factor . . . . .	25, 26	Detector, Voltmeter . . . . .	49
Radio-Frequency . . . . .	20, 36, 38, 39, 40, 42	Deviation Monitor, Frequency . . . . .	138
Resistance . . . . .	14, 16, 28		
U-H-F . . . . .	40		

## INDEX BY TITLE

	<i>Page</i>
Dial, Direct-Drive and Friction-Drive	237
Gear-Drive, Precision	236
Dial Drives, Synchronous	202
X-Y	203
Dial Drives, Automatic Sweep	199-202
Dielectric Measuring Bridge	18, 20, 24
Dielectric Sample Holder	22
Diode Modulator, Crystal	99, 100
Discriminator, Detector and	113
Direct-Current Amplifier	2
Distortion and Noise Meter	226
Drive, Dial	199-202
Drive, Sweep	200
Drum Controller	220
Dummy Antenna	98
Dynamic Microphone Assembly	181
Electrometer	2
F-M Monitor	139
Filter, Band-Pass	225
Coaxial	58
High-Pass	67
Low-Pass	58
Rejection	58
Tuned Circuit	65, 67
Wave	225
Flash, High Speed	196
Fork, Vacuum-Tube Driven	109
Frequency-Deviation Monitor	138
Frequency Measuring Equipment	77
Frequency Meter, Audio	89
Heterodyne	80, 85
Frequency Monitor	138, 141
Frequency Standard	74, 88
Friction-Drive Dial	237
Fuse Bolometer	51
Gear-Drive Dial	236
Generator, Oscillator	101-118
Pulse	119-123
Random-Noise	124
Square-Wave	114, 120, 122
Standard-Signal	90-100
Guard Circuit	22
Harmonic Analyzer	186, 190, 224
Heterodyne Frequency Meter	80, 85
High-Level Microphone	180
High-Pass Filter	67
High-Speed Light Source	192, 193, 194, 196
Impact Noise Analyzer	187
Impedance Bridge	26, 28, 34
Impedance-Matching Transformer	234
Inductance Bridge	30
Inductor, Decade	165, 166
Fixed	162, 163
Standard	162, 163, 164
Variable	164
Insulated Plugs	239
Insulators, Panel Terminal	241
Intermediate-Frequency Amplifier, Unit	68
Intermodulation Test Source	106
Interpolating Frequency Standard	86
Interpolation Equipment	77
Interpolation Oscillator	82
Jacks and Plugs	239
Jumbo Plugs and Jacks	239
Kit, Slotted Line	47
Klystron Oscillator	118
Knobs	238

	<i>Page</i>
Light Meter	136
Limit Bridge, Resistance	14
Limit Bridges	14, 31, 32
Lines and Line Elements, Coaxial	54
Line, Slotted	46
Loop, Test	98
Low-Distortion Oscillator	103
Low-Pass Filter	58
Matched Terminations, Coaxial	55
Mechanical Sweep Drive	200
Megohm Bridge	16
Megohmmeter	2, 132
Mega-megohmmeter	2
Meter, Audio Frequency	89
Distortion and Noise	226
Frequency Deviation	138
Heterodyne Frequency	80, 85
Light	136
Megohm	2, 132
Noise	178, 183
Output	133, 134
Sound-Level	178
Sound-Survey	183
U-H-F Admittance	40
Vacuum-Tube Voltmeters	128, 130
Vibration	188
Microflash	196
Micro-microammeter	2
Microphone Adaptor Plug	185
Microphone Assembly, Dynamic	181
Microphone System, Condenser	180
Microvolter	135
Mixer-Rectifier	51
Modulation Monitor	142
Modulator, Amplitude	99, 100
Modulator, Balanced	100
Modulator, Crystal Diode	99, 100
Modulator, Video	99, 100
Monitors, Frequency	138, 139, 140
Monitors, Modulation	139-143
Motor Drive, Slotted Line	48
Motor Drive, Dial	199-203
Motor Drive, Sweep	200
Motor Speed Controls	220-222
Multiplier (For Vacuum-Tube Voltmeter)	131
Multivibrators	75
Mutual Inductance Standard	164
Noise Analyzer, Impulse	187
Octave-Band	185
Noise Generator, Random	124
Noise Meter	178, 183
Null Detector and Amplifier	64
Null Detector, Unit	66
Octave-Band Noise Analyzer	185
Oscillator, Audio	82, 103-112, 114
Beat-Frequency	82, 104, 106
Dial Drive	199-203
Electro-Mechanical	109
Interpolation	82
Inverse Feedback	103, 108
Klystron	118
Piezo-Electric	75, 88
Radio-Frequency	80, 110, 113, 116-118
Resistance-Capacitance Tuned	103, 108, 114
Sweep Drive	200
Transistor	109
Tuning-Fork-Driven	109
Ultra-High-Frequency	116-118
Very-High-Frequency	116-117
Super-High-Frequency	118
Oscillator-Amplifier	29

# INDEX BY TITLE

	<i>Page</i>		<i>Page</i>
Oscillograph Recorder . . . . .	228	Stubs, Coaxial . . . . .	56
Oscilloscope, Comparison . . . . .	84	Sweep Drives . . . . .	48, 199-203
Output-Power Meter . . . . .	133, 134	Sweep Drive, Automatic . . . . .	200
Pad, Attenuator . . . . .	57, 181	Sweep Drive, Slotted Line . . . . .	48
Panel Terminal Insulator . . . . .	241	Sweep Generator, Pulse, Time Delay and . . . . .	120
Parts and Accessories . . . . .	229-242	Synchrometer . . . . .	75
Patch Cord . . . . .	242	Synchronous Dial Drives . . . . .	202
Pickup, Vibration . . . . .	182	Television Transmitter Monitor . . . . .	140
Piezo-Electric Oscillator . . . . .	75, 88	Terminations, Coaxial . . . . .	55
Plugs and Jacks . . . . .	239	Test Fixture, Capacitor . . . . .	21
Polariscope . . . . .	197	Test Loop . . . . .	98
Polyethylene Cable . . . . .	60	Thermistor . . . . .	51
Polystyrene Capacitors . . . . .	157, 158	Time-Delay, Pulse and Sweep Generator . . . . .	120
Potentiometers . . . . .	231-233	Time/Frequency Calibrator, Unit . . . . .	88
Power Amplifier . . . . .	4	Transformer, Adjustable (Variac®) . . . . .	206-217
Power Cord . . . . .	242	Bridge . . . . .	235
Power Meter, Output . . . . .	133, 131	Impedance Matching . . . . .	234
Power Output Transformer . . . . .	234	Power Output . . . . .	234
Power Supply . . . . .	144-148	Shielded . . . . .	235
Power Supply, Amplitude Regulating . . . . .	148	Toroidal . . . . .	234
Power Supply, Unit . . . . .	144-146	V-H-F . . . . .	98
Precision Capacitor . . . . .	151	Variac . . . . .	216
Precision Dial . . . . .	236	Transistor Oscillator . . . . .	109
Primary Frequency Standard . . . . .	74	Tripod and Extension Cable . . . . .	182
Pulse Amplifier, Unit . . . . .	123	Tuned-Circuit Filter . . . . .	65, 67
Pulse, Sweep and Time Delay Generator . . . . .	120	Tuning Fork Oscillator . . . . .	109
Pulsar, Unit . . . . .	122	Twin-T Impedance-Measuring Network . . . . .	42
Radio-Frequency Bridge . . . . .	36, 38, 39, 42	Two-Signal Audio Generator . . . . .	106
Radio-Frequency Oscillator . . . . .	110, 113, 116-118	U-H-F Coaxial Equipment . . . . .	45-62
Random Noise Generator . . . . .	121	U-H-F Heterodyne Frequency Meter . . . . .	85
R-C Oscillator . . . . .	103, 108, 114	U-H-F Oscillator . . . . .	116-118
Recorder, Oscillograph . . . . .	228	U-H-F Standard-Signal Generator . . . . .	92
Rectifier, Mixer . . . . .	51	Unit Instruments . . . . .	204-205
Rectifier, Voltmeter . . . . .	49	Universal Bridge . . . . .	28, 34
Regulated Power Supply, Unit . . . . .	145	Vacuum-Tube Bridge . . . . .	43
Regulating Power Supply, Amplitude . . . . .	148	Vacuum-Tube Voltmeters . . . . .	128, 130
Regulators, Line Voltage . . . . .	218	Variable Air Capacitor . . . . .	56, 151-153, 230
Rejection Filters, Coaxial . . . . .	58	Inductor . . . . .	164
Resistance Bridges . . . . .	14, 16, 28	Power Supply . . . . .	145
Resistance Meter, Megohm . . . . .	2, 132	Resistor . . . . .	231-233
Resistor, Compensated Decade . . . . .	172	Variac, Autotransformer . . . . .	206-217
Constant-Inductance . . . . .	172	Motor Speed Control . . . . .	220-222
Decade . . . . .	169-172	Transformer . . . . .	216
Fixed . . . . .	175	Voltage Regulator . . . . .	218
Variable . . . . .	231-233	Variometer . . . . .	164
Rheostat and Voltage Divider . . . . .	231-233	V-H-F Coaxial Equipment . . . . .	45-62
Rigid-Line Adaptors, Coaxial . . . . .	62	V-H-F Oscillators . . . . .	113, 116-117
Sample Holder, Dielectric . . . . .	23	V-H-F Standard-Signal Generators . . . . .	92
Secondary Frequency Standard . . . . .	74	Vibration Analyzer . . . . .	196
Shielded Transformer . . . . .	235	Vibration Meter . . . . .	188
Signal Generators, Standard . . . . .	90-100	Vibration Pickup . . . . .	182
Slotted Line . . . . .	46	Vibrator Power Supply, Unit . . . . .	146
Slotted-Line Motor Drive . . . . .	48	Voltage Divider . . . . .	98, 125, 174, 231
Smith Charts . . . . .	243	Voltage Divider (10:1) . . . . .	98
Sound Analyzer . . . . .	186	Voltage Divider (Decade) . . . . .	125, 174
Sound-Level Calibrator . . . . .	184	Voltage Divider (Rheostat) . . . . .	231
Sound-Level Meter . . . . .	178	Voltage Regulator, Automatic . . . . .	218
Sound-Survey Meter . . . . .	183	Voltmeter, Vacuum-Tube . . . . .	128, 130
Speed Controls, Motor . . . . .	220-222	Voltmeter Detector . . . . .	49
Square-Wave Generator . . . . .	114, 120, 122	Voltmeter Indicator . . . . .	49
Standard, Capacitance . . . . .	151-153, 154, 156	Voltmeter Rectifier . . . . .	49
Inductance . . . . .	162, 163, 164	Wave Analyzer . . . . .	186, 190, 224
Interpolating Frequency . . . . .	86	Wave Filter . . . . .	225
Mutual Inductance . . . . .	164	Waveform-Measuring Instruments . . . . .	223-228
Primary Frequency . . . . .	74	X-Y Dial Drives . . . . .	203
Secondary Frequency . . . . .	74	Z-Y Bridge . . . . .	34
Strobolume . . . . .	194		
Strobolux . . . . .	193		
Stroboscopes . . . . .	191-196		
Strobotac . . . . .	192		

# EXPORT DISTRIBUTORS

## AUSTRALIA

HAYWARD C. PARISH  
Box 2148 G.P.O.  
Sydney, Australia  
WARBURTON, FRANKI, LIMITED  
380 Bourke Street  
Melbourne, Australia

## BELGIUM

GROENEVELD, VAN DER POLL & CO'S.  
Electrotechnische Fabriek N.V.  
de Ruyterkade 41-43  
Amsterdam, Holland

## CANADA

CANADIAN MARCONI COMPANY, LTD.  
P. O. Box 1480, Station O  
Ville St. Laurent  
Montreal 9, Quebec, Canada  
CANADIAN MARCONI COMPANY, LTD.  
830 Bayview Avenue  
Toronto, Ontario, Canada

Other offices in St. John's, Newfoundland; Halifax, Nova Scotia; Winnipeg, Manitoba; Edmonton, Alberta; and Vancouver, British Columbia.

## DENMARK

MOGENS BANG & COMPANY, INC.  
91 Ryvangsalle  
Hellerup  
Copenhagen, Denmark

## EGYPT

MOUSTAPHA EZZAT ABDEL WAHAB & COMPANY  
106, Mohamed Bey Farid Street  
Post Office Box 1537  
Cairo, Egypt

## FINLAND

K. L. NYMAN  
11 Meritullinkatu  
Helsinki, Finland

## FRANCE

ETS. RADIOPHON  
50, Rue du Faubourg Poissonniere  
Paris 10, France  
RADIOPHON CORPORATION  
509 Madison Ave.  
New York 22, New York

## GREECE

K. KARAYANNIS  
Karitsi Square  
Athens, Greece

## INDIA

EASTERN ELECTRIC & ENGINEERING CO.  
127 Mahatma Gandhi Road  
P. O. Box 459  
Bombay, India

## ISRAEL

LANDSEAS EASTERN COMPANY  
P. O. Box 2554  
Tel Aviv, Israel  
LANDSEAS PRODUCTS CORPORATION  
48 West Forty-Eighth St.  
New York 36, New York

## ITALY

ING. S. & DR. GUIDO BELOTTI  
Piazza Trento, 8  
Milan, Italy

## JAPAN

MIDORIYA ELECTRIC COMPANY, LTD.  
3, 4-Chome Ginzaishi  
Chuo-ku  
Tokyo, Japan

## LATIN AMERICA

AD. AURIEMA, INC.  
89 Broad Street  
New York 4, New York  
Resident offices in principal cities of South America, Central America, Mexico, and the Caribbean area.

## NETHERLANDS

GROENEVELD VAN DER POLL & CO'S.  
Electrotechnische Fabriek N. V.  
de Ruyterkade 41-43  
Amsterdam, Holland

## NEW ZEALAND

HAYWARD C. PARISH  
Box 2148 G.P.O.  
Sydney, Australia  
SPEDDING, LIMITED  
Cor. Beach Road & Anzac Avenue  
Auckland, C.1, New Zealand

## NORWAY

MASKIN-AKTIESELSKAPET ZETA  
Drammensveien 26  
Oslo 22, Norway

## SOUTH AFRICA

G. H. LANGLER & COMPANY, LTD.  
249 Main Street  
Johannesburg, South Africa

## SPAIN and PORTUGAL

AD. AURIEMA, INC.  
89 Broad Street  
New York 4, New York  
Resident offices in Madrid and Lisbon.

## SWEDEN

JOHN C. LAGERCRANTZ  
Vartavagen 57  
Stockholm, Sweden

## SWITZERLAND

SEYFFER AND COMPANY, INC.  
Badenerstrasse 265  
Zurich, 3/40, Switzerland

## TURKEY

ETABLISSEMENT MEHMET VASFI  
Boite Postale Istanbul 143  
Istanbul, Turkey

## UNITED KINGDOM

CLAUDE LYONS, LIMITED  
76 Old Hall Street  
Liverpool, England  
CLAUDE LYONS, LIMITED  
Valley Works  
4-10 Ware Road  
Hoddesdon, Herts, England

GENERAL RADIO COMPANY

vi	HOW TO ORDER	
viii	AMPLIFIERS	
6	BRIDGES	
44	COAXIAL ELEMENTS	
62	DETECTORS	
70	FREQUENCY AND TIME	
90	STANDARD-SIGNAL	GENERATORS
100	OSCILLATORS	
118	PULSE, RANDOM NOISE	
126	METERS	
136	MONITORS FOR RADIO AND TV STATIONS	
144	POWER SUPPLIES	
148	REACTANCE	CAPACITORS INDUCTORS
166	RESISTORS	
176	SOUND AND VIBRATION	
190	STROBOSCOPES	
198	SWEEP DRIVES	
204	UNIT INSTRUMENTS	
206	VARIAC <sup>®</sup>	AUTOTRANSFORMERS AUTOMATIC VOLTAGE REGULATOR MOTOR SPEED CONTROLS
222	WAVEFORM-MEASURING EQUIPMENT	
228	PARTS AND ACCESSORIES	
242	CHARTS, TABLES, AND INDEXES	



**CATALOG O**  
**GENERAL RADIO COMPANY**  
*Cambridge 39, Massachusetts*  
 U. S. A.

BRANCH ENGINEERING OFFICES: NEW YORK • CHICAGO  
 LOS ANGELES • WASHINGTON, D. C. • PHILADELPHIA  
 (See inside front cover)

DISTRIBUTORS IN PRINCIPAL FOREIGN COUNTRIES  
 (See inside back cover)